



OPERATING GUIDE

VHF DIGITAL TRANSCEIVERS

IC-F3400D series

IC-F5400D series

UHF DIGITAL TRANSCEIVERS

IC-F4400D series

IC-F6400D series

INTRODUCTION

1 ACCESSORIES

2 PANEL DESCRIPTION

3 BASIC OPERATION

4 ADVANCED OPERATION

5 SCAN OPERATION

6 MENU SCREEN

7 NXDN OPERATION

8 MDC 1200 SYSTEM OPERATION

9 BIIS 1200 SYSTEM OPERATION

10 ABOUT THE microSD CARD

11 VOICE RECORDER FUNCTIONS

12 Bluetooth® OPERATION

13 USER SETTINGS

14 OTHERS

15 OPTIONS

INDEX

INTRODUCTION

Thank you for choosing this Icom product. This product is designed and built with Icom's state of the art technology and craftsmanship. With proper care, this product should provide you with years of trouble-free operation.

IMPORTANT

FIRST, CAREFULLY READ PRECAUTIONS AND INSTRUCTIONS that are provided with the transceiver.

SAVE THIS OPERATING GUIDE— This operating guide contains additional important operating instructions for the following transceivers.

Portable

- IC-F3400D/IC-F4400D: Non-display type transceivers
- IC-F3400DS/IC-F4400DS: Simple key type transceivers
LCD + [P1] + [P2] + [OK]
+ [Back]
- IC-F3400DT/IC-F4400DT: Ten-key type transceivers
LCD + [P1] + [P2] + [OK]
+ [Back] + Ten-key Pad

Mobile

- IC-F5400D/IC-F6400D: LCD type transceivers
- IC-F5400DS/IC-F6400DS: Segment type transceivers

In this operating guide, Ten-key type (Handheld) and LCD type (Mobile) are used for the main illustration.

Icom, Icom Inc. and Icom logo are registered trademarks of Icom Incorporated (Japan) in Japan, the United States, the United Kingdom, Germany, France, Spain, Russia, Australia, New Zealand, and/or other countries.

AQUAQUAKE is a trademark of Icom Incorporated.

NXDN is a trademark of Icom Incorporated and JVC KENWOOD Corporation.

LTR is a trademark of the E.F. Johnson Technologies, Inc.

The Bluetooth® word mark and logos are registered trademarks owned by Bluetooth SIG, Inc. and any use of such marks by Icom Inc. is under license.

All other products or brands are registered trademarks or trademarks of their respective holders.

Icom is not responsible for the destruction, damage to, or performance of any Icom or non-Icom equipment, if the malfunction is because of:

- Force majeure, including, but not limited to, fires, earthquakes, storms, floods, lightning, other natural disasters, disturbances, riots, war, or radioactive contamination.
- The use of Icom transceivers with any equipment that is not manufactured or approved by Icom.

Section 1 ACCESSORIES

Supplied accessories.....	1-2
Attaching accessories.....	1-3
◇ Flexible antenna (Portable).....	1-3
◇ Battery pack (Portable).....	1-3
◇ Belt clip (Portable).....	1-4
◇ Connector cover (Portable).....	1-5
◇ Mounting bracket (Mobile).....	1-6

Supplied accessories

The following accessories are supplied.

NOTE: Some accessories are not supplied, or the shape is different, depending on the transceiver version.

● Portable type transceiver

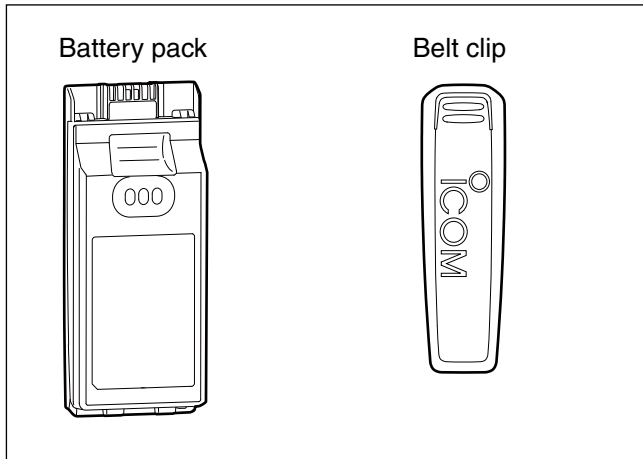

● Mobile type transceiver

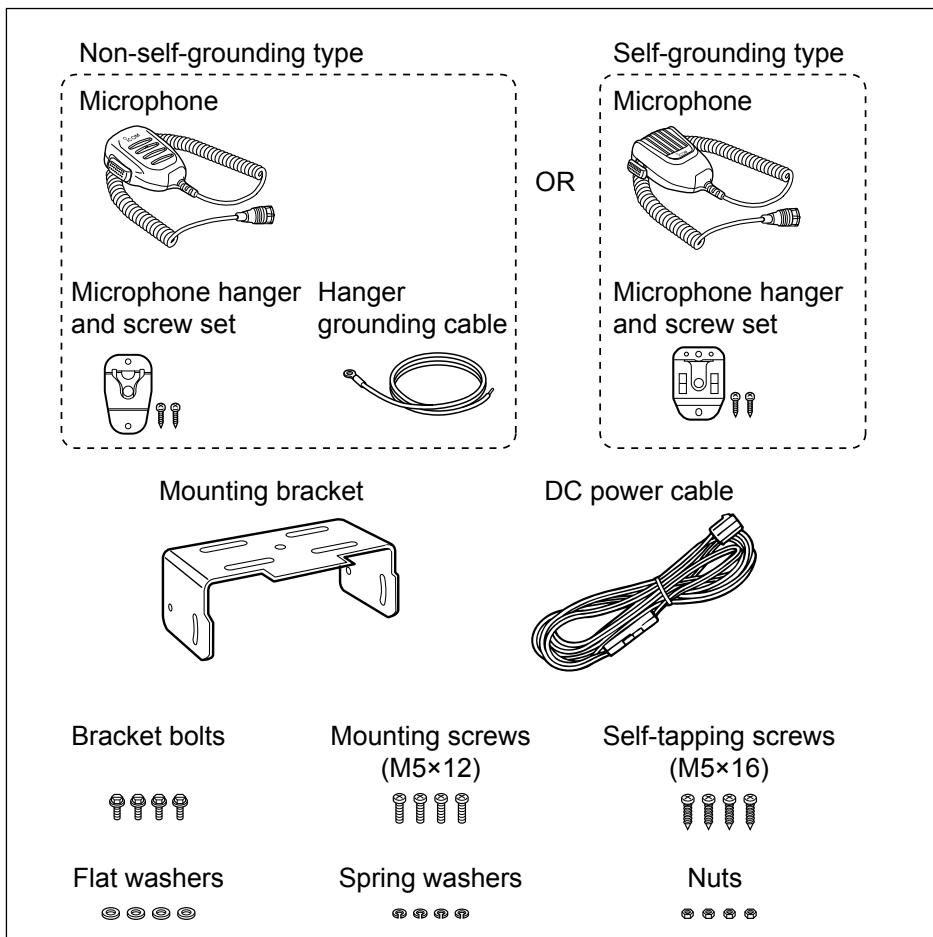

Attaching accessories

◇ Flexible antenna (Portable)

Connect the supplied flexible antenna to the antenna connector.

CAUTION:

- **DO NOT** carry the transceiver by holding only the antenna.
- **DO NOT** connect an antenna other than those listed in the INSTRUCTIONS.
- Transmitting without an antenna may damage the transceiver.

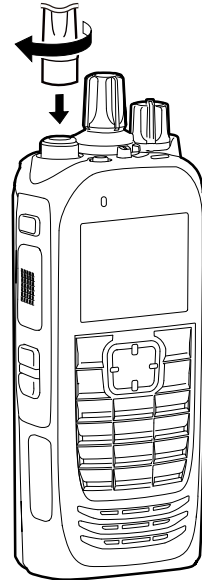

◇ Battery pack (Portable)

CAUTION: DO NOT attach or detach the battery pack when the transceiver is wet or soiled. This may result in water or dust getting into the transceiver/ battery pack and may damage the transceiver.

To attach:

1. Slide the battery pack in the direction of the arrow. (1)
2. Push the battery pack until the battery sliding locks make a 'click' sound. (2)

To detach:

1. Push both battery sliding locks in the direction of the arrow. (1)
 - The battery pack is then released.
2. Lift up to detach the battery pack. (2)

NOTE: Keep the battery pack terminals clean. It's a good idea to occasionally clean them.

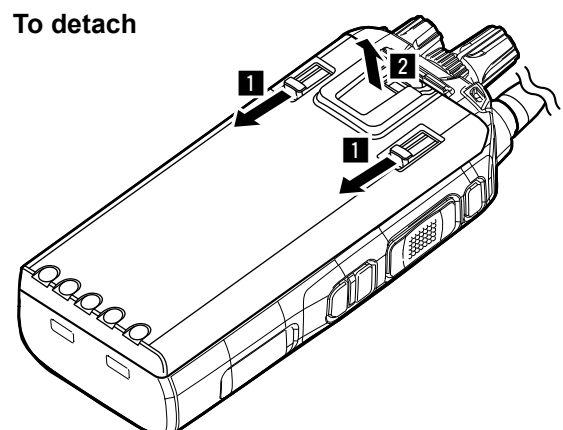
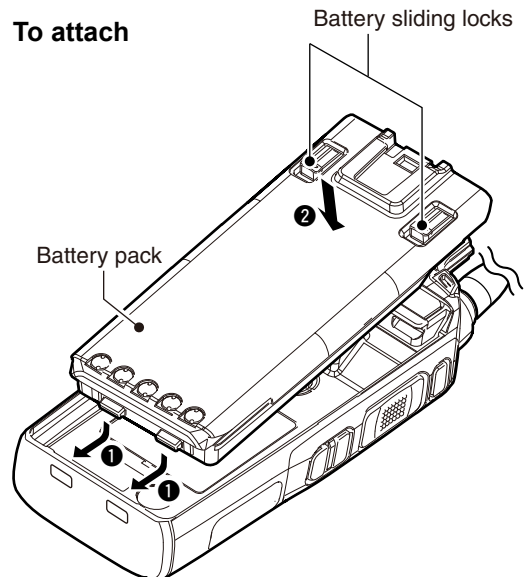

Attaching accessories

◇ **Belt clip (Portable)**

To attach:

1. Remove the battery pack from the transceiver, if it is attached.
2. Slide the belt clip in the direction of the arrow until the belt clip is locked and makes a 'click' sound.

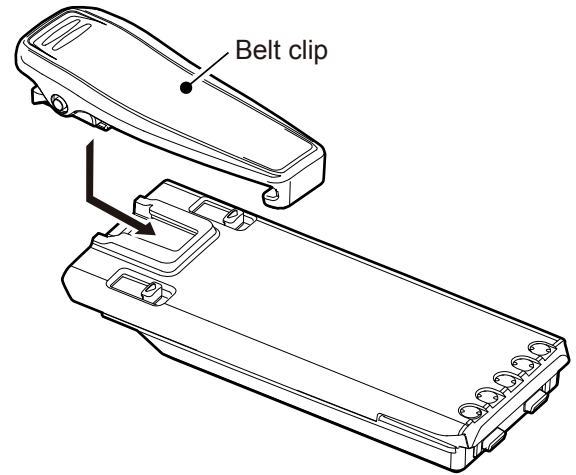

To detach:

Lift the tab up (①), and slide the belt clip in the direction of the arrow (②).

BE CAREFUL! Don't break your fingernail.

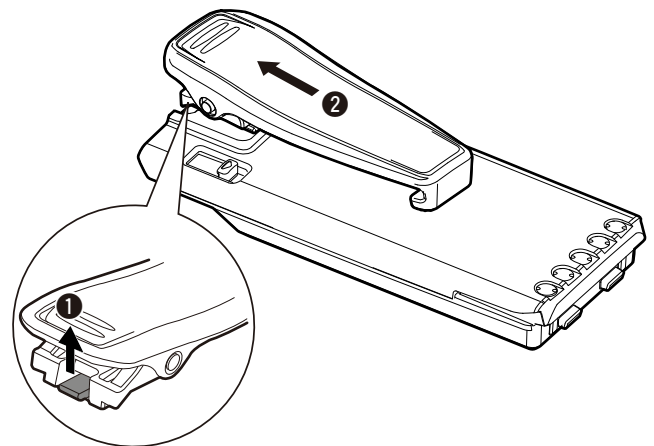

Attaching accessories

◇ Connector cover (Portable)

To attach:

1. Attach the connector cover over the multi-connector. (1)
2. Tighten the screw. (2)

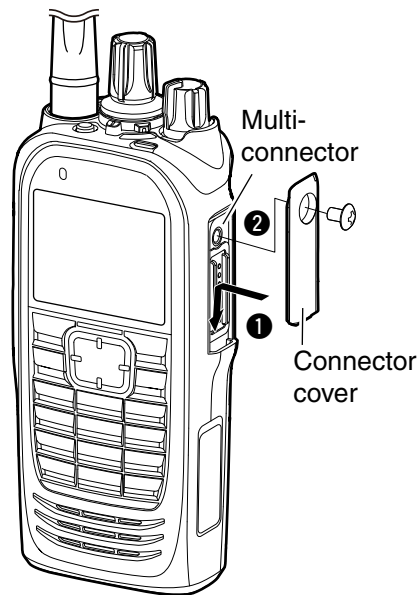

To detach:

1. Remove the screw. (1)
2. Detach the connector cover, and then connect an optional equipment. (2)

CAUTION: DO NOT detach the connector cover when optional equipment is not in use. Otherwise the terminals of the multi-connector may be shorted by a metal object, or become rusty by water intrusion. This could damage the transceiver.

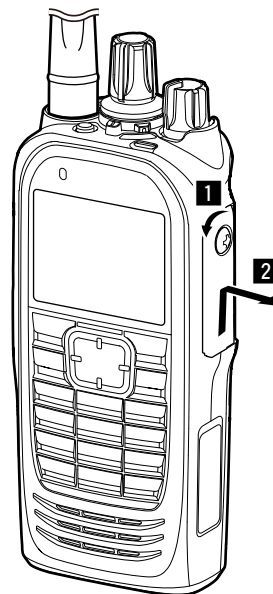

Attaching accessories

◇ **Mounting bracket (Mobile)**

Install the mounting bracket in a place where it can be firmly attached.

- ① We recommend that you periodically check whether the screws are loose or not, especially after a long period of use.

CAUTION: DO NOT use bolts other than the ones that are supplied with the mounting bracket. Bolt longer than 8 mm (0.31 in) may damage the transceiver's internal units.

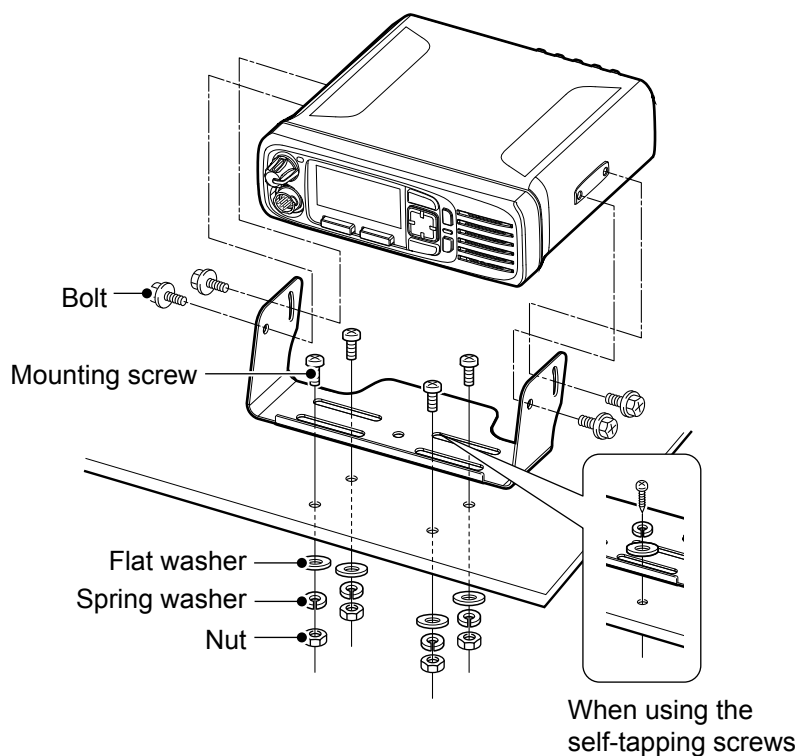

- Front, top and side panels (for the Portable type transceiver).....2-2
 - ◇ About the transceiver types2-2
 - ◇ About the Status indicator.....2-2
 - ◇ About the Multi-connector.....2-2
 - ◇ About the Software key functions2-2
- Function display (for the Portable type transceiver)2-3
 - ◇ Icon Area.....2-3
 - ◇ Text Area.....2-4
 - ◇ Key Display Area2-4
- Front, top and side panels (for the Mobile type transceiver)2-5
 - ◇ About the transceiver types2-5
 - ◇ About the Status indicator.....2-5
 - ◇ About the Microphone connector.....2-5
 - ◇ About the Software key functions2-5
- Rear panel (for the Mobile type transceiver)2-6
- Function display (for the Mobile type transceiver)2-7
 - ◇ Icon Area.....2-7
 - ◇ Text Area.....2-8
 - ◇ Key Display Area2-8
- Status indicator.....2-9
- Assignable keys, keypads, and Lever switch2-11
 - ◇ Portable type.....2-11
 - ◇ Mobile type2-12
- Assignable Software key functions.....2-13
 - ◇ For keys and keypads.....2-13
 - ◇ For the Lever switch (For the Portable type transceiver).....2-23

Front, top and side panels (for the Portable transceiver)

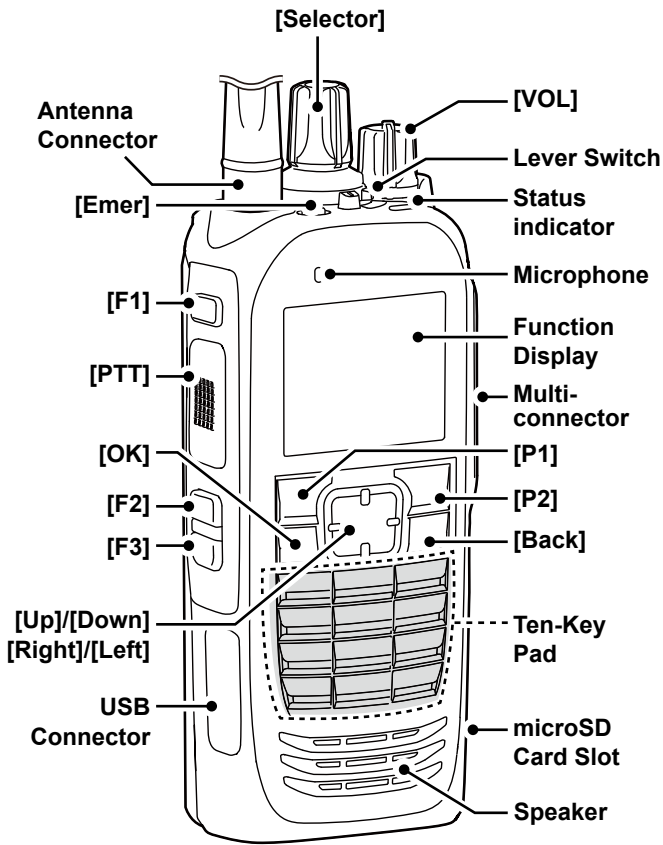

The illustration is of the Ten-key types.

◇ **About the transceiver types**

There are 3 types of transceivers in the IC-F3400D and IC-F4400D series.

IC-F3400D, IC-F4400D: Non-display types

IC-F3400DS, IC-F4400DS: Simple key types

IC-F3400DT, IC-F4400DT: Ten-key types

◇ **About the Status indicator**

- Lights red while transmitting.
- Lights green while receiving a signal, or when the squelch is open.
- Blinks magenta when the battery is exhausted.

◇ **About the Multi-connector**

Connects to an optional speaker microphone or headset.

CAUTION: DO NOT use the transceiver without the connector cover or optional equipment attached. The transceiver meets IP68 requirements for dust-tight and waterproof protection only when the connector cover or the optional HM-222 is attached.

◇ **About the Software key functions**

NOTE: Dealers can assign the Software key functions to the keys, keypads, and the Lever switch.

① See page 2-11 for details.

Function display (for the Portable type transceiver)

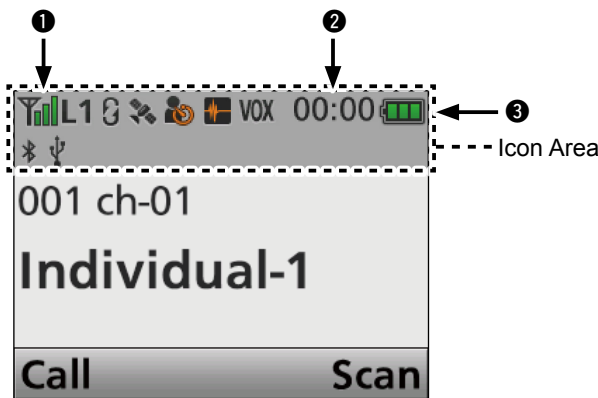

NOTE: The screen capture is an example. The displayed position of each icon may differ, depending on the function being used.

◇ Icon Area

Indicators

① SIGNAL STRENGTH INDICATOR

Displays the relative receive signal strength level.

② CLOCK

Displays the current time.

- ① “AM” or “PM” is displayed beside the time display when the 12 hour display format is selected.
- ① “--:--” is displayed instead of the current time when the internal clock is not set.

③ BATTERY INDICATOR

Displayed or blinks to indicate the battery status.

Indication				
Battery status	Full	Mid	Charging required	Battery exhausted

blinks when the battery is exhausted.

Icons

The following icons are displayed in the Icon Area.

POWER ICON

- “L1” is displayed when the output power is set to Low.
- “L2” is displayed when the output power is set to Mid.
- “H” is displayed when the output power is set to High.

AUDIBLE ICON

Displayed when the channel is in the ‘audible’ (unmute) mode.

MESSAGE ICON

- Blinks after Messages (Message or Status Message) have been received.
- Stops blinking when the screen is changed, or any key is pushed, but is displayed if unread messages are still in the Message memory.
- Disappears when all messages in the Message memory have been read.

BELL ICON

Displayed when a matching signal is received, depending on the presetting.

SCAN ICON

- Displayed when a scan is paused.
- Blinks while scanning.

SCAN TARGET CHANNEL ICON

Displayed when the channel is selected as a scan target channel.

SCRAMBLER ICON

In the Analog mode

Displayed when the Voice Scrambler function is ON.

In the Digital mode

- Displayed when the Voice Encryption function is ON.
- Blinks when decoding an encrypted signal.

GPS ICON

- Displayed when valid position data is received.
- Blinks when searching for satellites or calculating position data.
- ① Depending on the presetting, the GPS icon is not displayed.

RECORD ICON

- Displayed when the Record function is ON.
- Blinks while recording audio.
- ① Depending on the presetting, the record icon is not displayed.

TALK AROUND ICON

Displayed when the Talk Around function is ON.

PHONE ICON

- Displayed when the transceiver is connected to a telephone network on the selected channel.
- Blinks while receiving a phone call.

SITE LOCK ICON

Displayed when the Site Lock function is ON.

LONE WORKER ICON

Displayed when the Lone Worker function is ON.

MOTION SENSOR ICON

Displayed when the Motion Sensor function is ON.

NOISE CANCEL ICON

Displayed when the Noise Cancel function is ON.

Continued on the next page

Function display (for the Portable type transceiver)

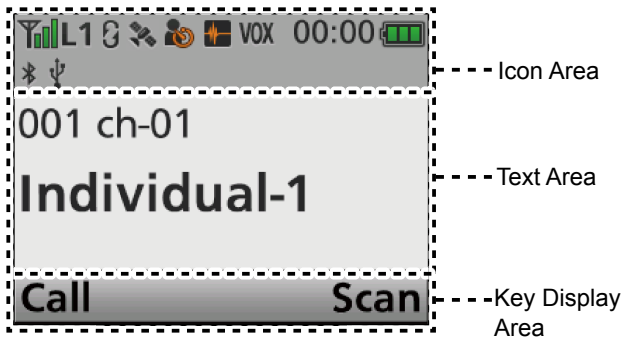

NOTE: The screen capture is an example. The displayed position of each icon may differ, depending on the function being used.

Icons (Continued)

SURVEILLANCE ICON

Displayed when the Surveillance function is ON.

VIBRATION ICON

Displayed when the Vibration function is ON.

VOX ICON

Displayed when the VOX function is ON.

Bluetooth® ICON

- Displayed when Bluetooth® is activated.
- Lights Blue when a Bluetooth® device is connected.
- Does not light when no Bluetooth® device is connected.

microSD ICON

Displayed when the microSD card is inserted into the card slot.

- ① is displayed when the microSD card has not been formatted.
- ① Depending on the presetting, the microSD icon is not displayed.

USB ICON

Displayed when a USB device is connected.

SHIFT ICON

Displayed when the Shift mode is ON.

- ① A user can use a Software key's secondary function in the Shift mode.

◇ **Text Area**

Displays the selected Zone number, Channel number, and Channel name, if set.

◇ **Key Display Area**

Displays the names of the function assigned to [P1] and [P2].

Front, top and side panels (for the Mobile type transceiver)

● LCD type

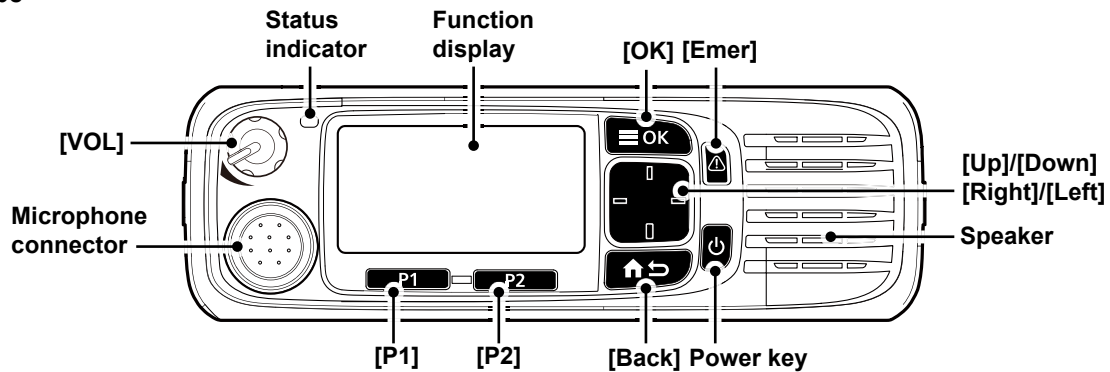

● Segment type

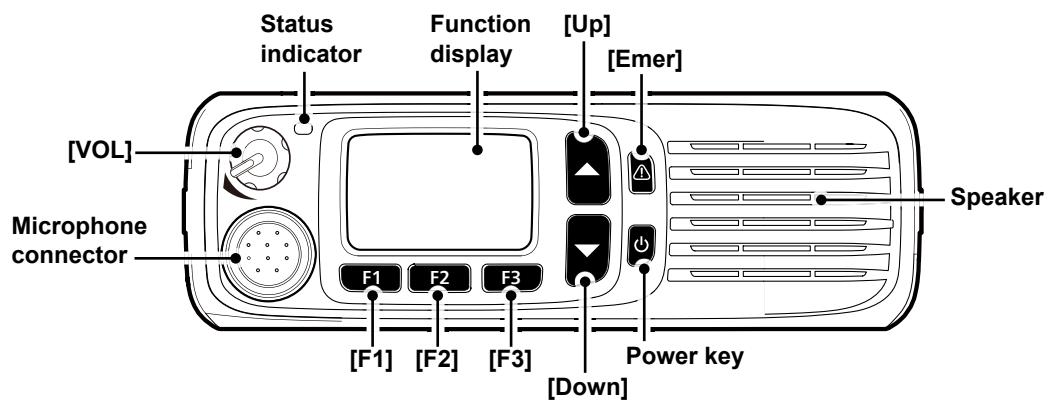

◇ About the transceiver types

There are 2 types of transceivers in the IC-F5400D and IC-F6400D series.

IC-F5400D, IC-F6400D: LCD types

IC-F5400DS, IC-F6400DS: Segment types

◇ About the Status indicator

- Lights red while transmitting.
- Lights green while receiving a signal, or when the squelch is open.

◇ About the Microphone connector

Connect the supplied or optional microphone.

CAUTION: DO NOT connect non-specified microphones. The pin assignments may be different and may damage the transceiver.

◇ About the Software key functions

NOTE: Dealers can assign the Software key functions to the keys and keypads, except for the Power key.

① See page 2-13 for details.

Rear panel (for the Mobile type transceiver)

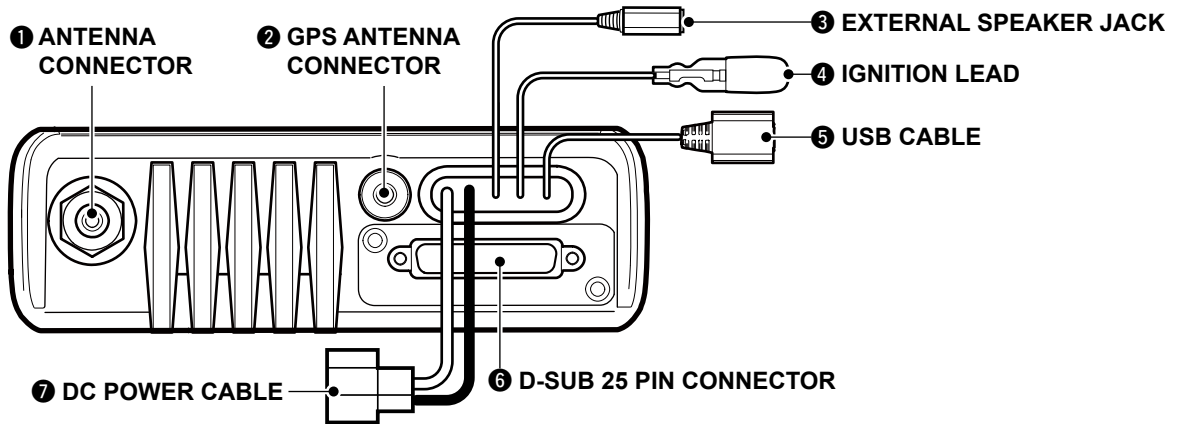

1 ANTENNA CONNECTOR

Connect to an antenna.

2 GPS ANTENNA CONNECTOR

Connect the UX-241 GPS antenna.

3 EXTERNAL SPEAKER JACK

Connect a 4 ~ 8 Ω external speaker.

4 IGNITION LEAD

Connects to a vehicle ignition line.

CAUTION: DO NOT put pressure on this lead.
Binding to the DC power cable is recommended.

5 USB CABLE

Connects to a PC.

6 D-SUB 25 PIN CONNECTOR

Connects to an external unit.

NOTE: When connecting an external unit to this connector, be sure to firmly tighten the screws.

7 DC POWER CABLE

Connects to a 12 V DC battery.
Pay attention to polarities.

CAUTION: DO NOT connect to a 24 V battery.
This will damage the transceiver.

Function display (for the Mobile type transceiver)

● LCD type

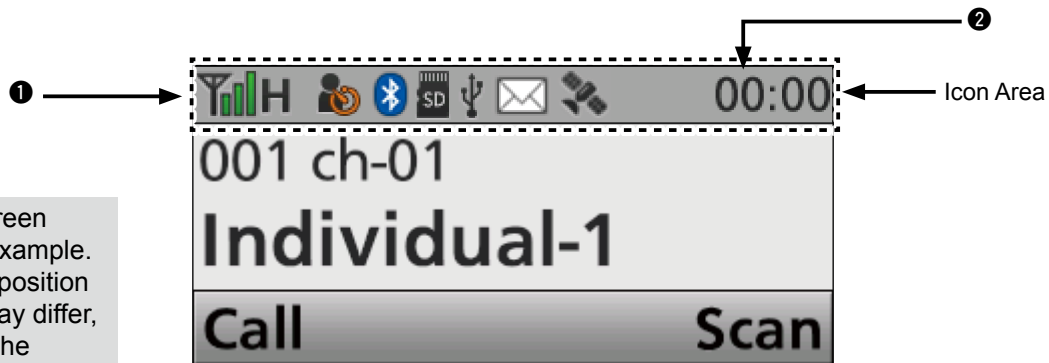

NOTE: The screen capture is an example. The displayed position of each icon may differ, depending on the function being used.

◇ Icon Area

Indicators

① **SIGNAL STRENGTH INDICATOR**

Displays the relative received signal strength.

② **CLOCK**

Displays the current time.

① “AM” or “PM” is displayed beside the time display when the 12 hour display format is selected.

① “--:--” is displayed instead of the current time when the internal clock is not set.

Icons

The following icons are displayed in the Icon Area.

POWER ICON

- “L1” is displayed when the output power is set to Low.
- “L2” is displayed when the output power is set to Mid.
- “H” is displayed when the output power is set to High.

AUDIBLE ICON

Displayed when the channel is in the ‘audible’ (unmute) mode.

MESSAGE ICON

- Blinks after Messages (Message or Status Message) have been received.
- Stops blinking when the screen is changed, or any key is pushed, but is displayed if unread messages are still in the Message memory.
- Disappears when all messages in the Message memory have been read.

BELL ICON

Displayed when a matching signal is received, depending on the presetting.

SCAN ICON

- Displayed when a scan is paused.
- Blinks while scanning.

SCAN TARGET CHANNEL ICON

Displayed when the channel is selected as a scan target channel.

SCRAMBLER ICON

In the Analog mode

Displayed when the Voice Scrambler function is ON.

In the Digital mode

- Displayed when the Voice Encryption function is ON.
- Blinks when decoding an encrypted signal.

GPS ICON

- Displayed when a valid position data is received.
- Blinks when searching for satellites or calculating position data.

① Depending on the presetting, the GPS icon is not displayed.

RECORD ICON

- Displayed when the Record function is ON.
- Blinks while recording the audio.

TALK AROUND ICON

Displayed when the Talk Around function is ON.

PHONE ICON

- Displayed when the transceiver is connected to a telephone network on the selected channel.
- Blinks while receiving a phone call.

SITE LOCK ICON

Displayed when the Site Lock function is ON.

LONE WORKER ICON

Displayed when the Lone Worker function is ON.

NOISE CANCEL ICON

Displayed when the Noise Cancel function is ON.

SURVEILLANCE ICON

Displayed when the Surveillance function is ON.

VOX ICON

Displayed when the VOX function is ON.

Function display (for the Mobile type transceiver)

● LCD type

NOTE: The screen capture is an example. The displayed position of each icon may differ, depending on the function being used.

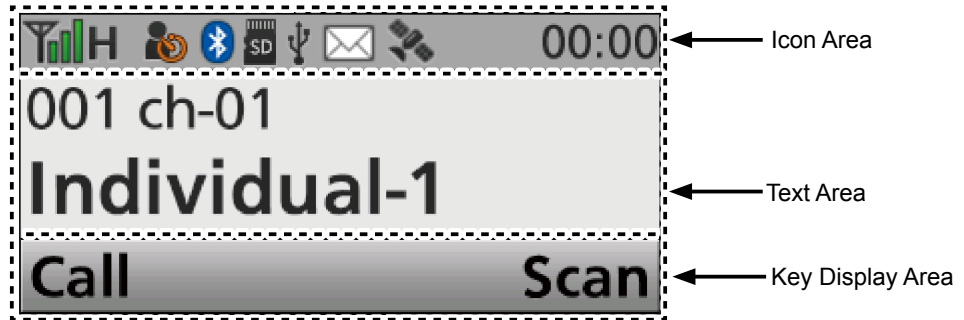

Icons (Continued)

Bluetooth® ICON

- Displayed when Bluetooth® is activated.
- Lights Blue when a Bluetooth® device is connected.
- Does not light when no Bluetooth® device is connected.

microSD ICON

- Displayed when a microSD card is inserted.
- ① is displayed when the microSD card has not been formatted.
 - ① Depending on the presetting, the microSD icon is not displayed.

USB ICON

Displayed when a USB device is connected.

SHIFT ICON

- Displayed when the Shift mode is ON.
- ① A user can use a Software key's secondary function in the Shift mode.

● Segment type

The number that is displayed on the segment type screen is called "Position." The position number is selected by pushing [Up] or [Down].

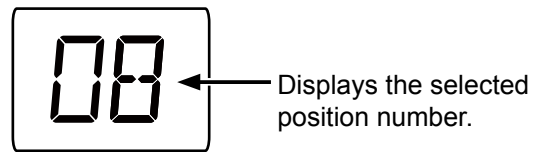

◇ Text Area

Displays the selected Zone number, Channel number, and Channel name, if set.

◇ Key Display Area

Displays the names of the function assigned to [P1] and [P2].

Status indicator

The Status indicator indicates the status of various parameters of the transceiver as described below. (Reference: R=Red, G=Green, Y=Yellow, M=Magenta, W=White, B=Blue)

- Programming:
Blinks while reading or writing data.
- Programming Error:
Blinks if cloning fails.
- Channel Error:
Blinks when you select a blank channel, or an unlocked channel.
- TX low Battery 1:
Blinks while detecting a low battery in the TX mode.
- TX low Battery 2:
Blinks while detecting a very low battery in the TX mode.
- TX:
Lights while transmitting.
- Bell (Blink):
Blinks about twice every second.
- Bell (ON):
Blinks about once every second.

TIP: Depending on the “Bell” setting, the Status indicator blinks:

- When a call that includes a matching 2-Tone code is received.
- When a call that includes a matching 5-Tone code is received.
- When a Call Alert is received.
- When a Message is received.
- When a Status call that includes a matching status number is received.

- Scan, Hunt:
Blinks while scanning for a channel to search for a signal, or while hunting for a control channel.
- RX:
Lights while receiving a signal.
- CH Access:
Blinks while making a call.
- Audible:
Blinks while in the Audible mode.
- Low Battery 1:
Blinks slowly when you should charge the battery soon.

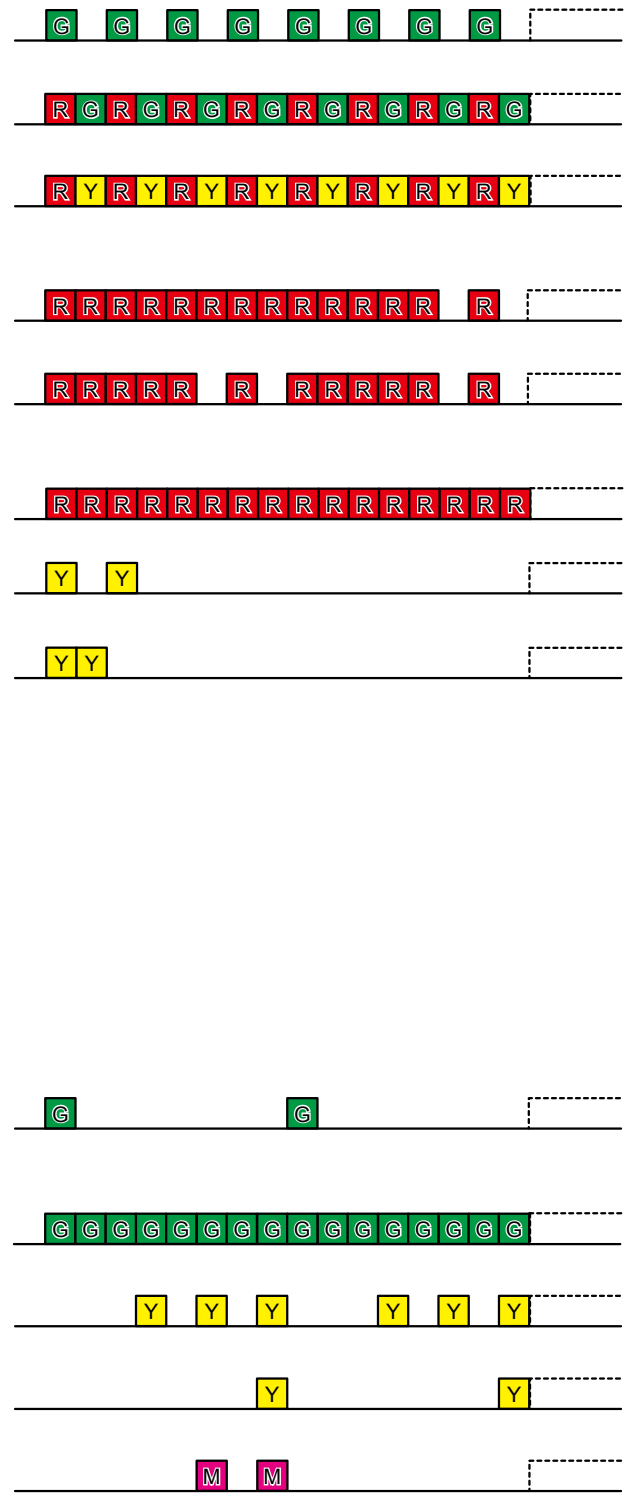

Continued on the next page.

2 PANEL DESCRIPTION

Status indicator

- Low Battery 2:
Blinks fast when you must charge the battery.

NOTE: Depending on the presetting, the Status indicator does not blink when the battery is low.

- ① Set the related item using the CS-F3400D PROGRAMMING SOFTWARE.
 - For the Portable Ten-Key types and Simple key types:
(Common - Battery Setting - Low Battery LED - **Display + Status Indicator**)
 - For the Portable Non-display types:
(Common - Battery Setting - Low Battery LED - **Status Indicator**)

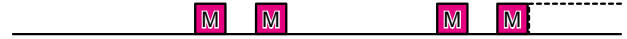

- Power ON:
Lights white, then blinks red, yellow, and green at transceiver startup.

NOTE: When the transceiver has an Over The Air Programming (OTAP) data to be programmed and the date and time are not set to the transceiver, the status indicator blinks magenta at transceiver startup. In this case, set the date and time (MENU > Clock > **Clock Adjust**) or contact your OTAP manager to surely complete the OTAP.



- Success:
Blinks slowly when your call was successful.
- Failure:
Blinks slowly when your call failed, or it was refused.
- TX Error:
Blinks when inhibiting transmission (Lockout, TX Inh, or TOT Penalty timer).
- Emergency:
Blinks while the Emergency Locator tone is sounding.
- Searching (Bluetooth®):
Blinks while searching for the Bluetooth® device.
- Waiting Paring (Bluetooth®):
Blinks while in the Waiting Pairing mode.
- Success (Bluetooth®):
Blinks when the Bluetooth® connection is successful.
- Failure (Bluetooth®):
Blinks when the Bluetooth® connection is failed.



Assignable keys, keypads, and Lever switch

◇ Portable type

Dealers can assign the Software key functions to the following keys, keypads, and the Lever switch.

Non-display type

[F1], [F2], [F3], [Emer], and the Lever switch

Simple key type

[P1], [P2], [Up], [Down], [Left], [Right], [OK], [Back], [F1], [F2], [F3], [Emer], and the Lever switch

Ten-key type

[P1], [P2], [Up], [Down], [Left], [Right], [OK], [Back], [F1], [F2], [F3], [Emer], Keypad 0~9, *, #, and the Lever switch

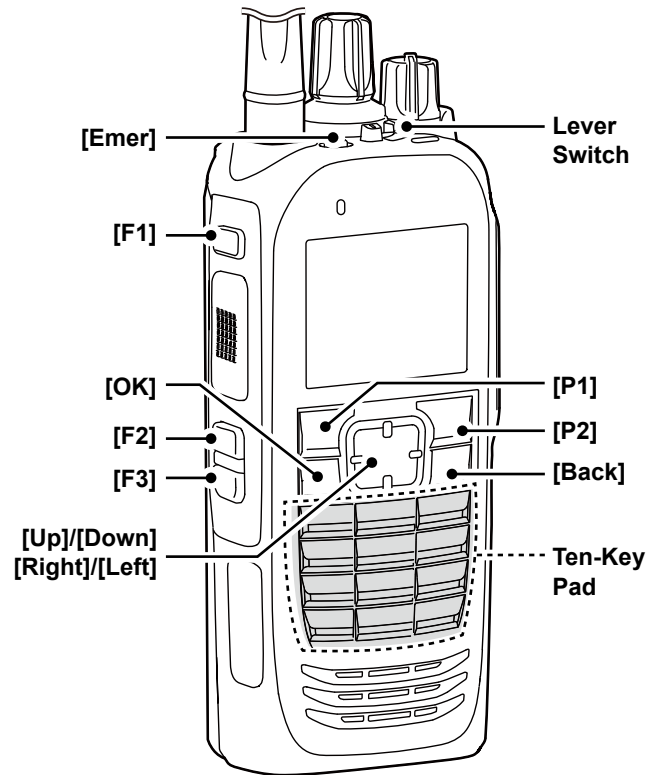

The illustration is of the Ten-key types.

Assignable keys, keypads, and Lever switch

◇ **Mobile type**

Dealers can assign the Software key functions to the following keys and keypads.

LCD type:

[P1], [P2], [Up], [Down], [Left], [Right], [OK], [Back], and [Emer]

Segment type:

[Up], [Down], [F1], [F2], [F3], and [Emer]

Optional HM-218 HAND MICROPHONE:

[P1], [P2], [Up], [Down], [Left], [Right], [OK], [Back], [Emer], Keypad 0~9, *, and #

● **LCD type**

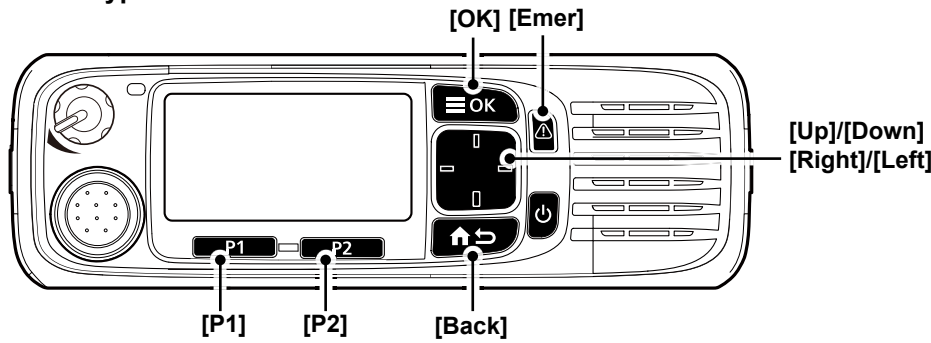

● **Segment type**

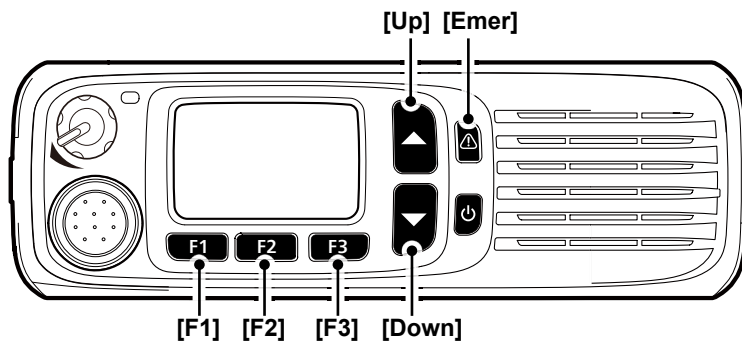

● **HM-218**

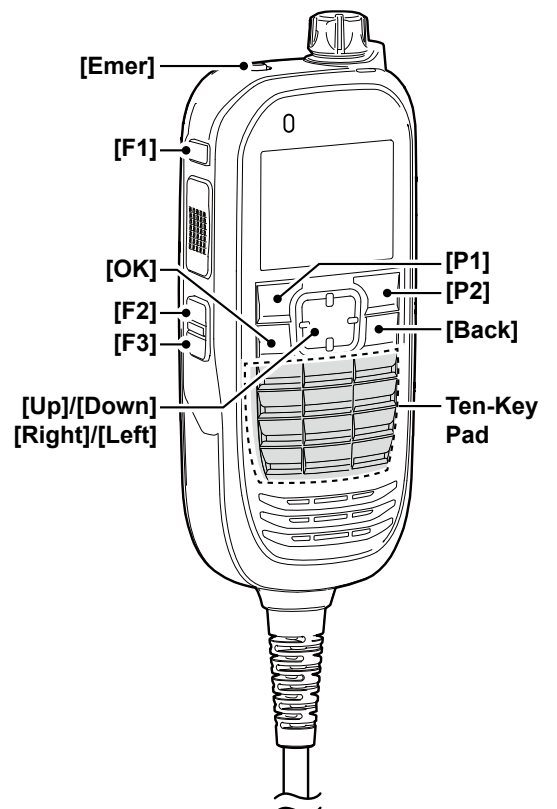

Assignable Software key functions

◇ For keys and keypads

Category	Assignable function	Digital (NXDN)			Analog				
		Conventional	Single-site Trunk	Multi-site Trunk	2-Tone	5-Tone	LTR	MDC	BIIS
-	Disable (p. 2-16)	✓	✓	✓	✓	✓	✓	✓	✓
	Null (p. 2-16)	✓	✓	✓	✓	✓	✓	✓	✓
	Menu* ¹ (p. 2-16)	✓	✓	✓	✓	✓	✓	✓	✓
	Home (p. 2-16)	✓	✓	✓	✓	✓	✓	✓	✓
	Shift (p. 2-16)	✓	✓	✓	✓	✓	✓	✓	✓
Channel/ Scan (Voting)	CH Up* ² , CH Down* ² (p. 2-16)	✓	✓	✓	✓	✓	✓	✓	✓
	Prio A, Prio B (p. 2-16)	✓	✓	✓	✓	✓	✓	✓	✓
	Prio A (Rewrite), Prio B (Rewrite) (p. 2-16)	✓	✓	✓	✓	✓	✓	✓	✓
	Zone Up* ¹ , Zone Down* ¹ (p. 2-16)	✓	✓	✓	✓	✓	✓	✓	✓
	Zone Select* ¹ (p. 2-16)	✓	✓	✓	✓	✓	✓	✓	✓
	Scan Start/Stop (p. 2-16)	✓	✓	N/A	✓	✓	✓	✓	✓
	Scan Add/Del (Tag)* ¹ (p. 2-17)	✓	✓	N/A	✓	✓	✓	✓	✓
	High/Low (p. 2-17)	✓	✓	✓	✓	✓	✓	✓	✓
	C.Tone CH Select* ¹ (p. 2-17)	N/A	N/A	N/A	✓	✓	N/A	✓	✓
	Tone/RAN CH Select* ¹ (p. 2-17)	✓	N/A	N/A	✓	✓	N/A	✓	✓
	Monitor (p. 2-17)	✓	N/A	N/A	✓	✓	✓	✓	✓
	Talk Around (p. 2-17)	✓	✓	✓	✓	✓	✓	✓	✓
	Bandwidth (p. 2-17)	N/A	N/A	N/A	✓	✓	✓	✓	✓
	Scrambler/Encryption (p. 2-17)	✓	✓	✓	✓	✓	✓	✓	✓
	Compander (p. 2-17)	N/A	N/A	N/A	✓	✓	✓	✓	✓

➤ Continued on the next page

✓: Applicable

N/A: Not Applicable

Depending on the transceiver's model type, some functions may not be assignable.

*¹ For only the Portable Ten-key type, Portable Simple key type, or Mobile LCD type transceivers.

*² For only the Portable Ten-key type, Portable Simple key type, Mobile LCD type or Mobile Segment type transceivers.

*³ For only Mobile type transceivers.

*⁴ For only Portable type transceivers.

*⁵ For only Portable Non-display type or Mobile Segment type.

2 PANEL DESCRIPTION

Assignable Software key functions

◇ For keys and keypads (Continued)

Category	Assignable function	Digital (NXDN)			Analog				
		Conventional	Single-site Trunk	Multi-site Trunk	2-Tone	5-Tone	LTR	MDC	BIIS
Signaling / Call	Call (p. 2-18)	✓ ^{*5}	✓ ^{*5}	✓ ^{*5}	✓	✓	✓	✓	✓
	Call A/Call B (p. 2-18)	✓	✓	✓	✓	✓	✓	✓	✓
	Re-dial (p. 2-18)	✓	✓	✓	✓	✓	✓	✓	✓
	Call List Select* ¹ (p. 2-18)	✓	✓	✓	✓	✓	✓	✓	✓
	Call Menu* ¹ (p. 2-18)	✓	✓	✓	✓	✓	✓	✓	✓
	DTMF Autodial (p. 2-18)	✓	✓	✓	✓	✓	✓	✓	✓
	Emergency (p. 2-18)	✓	✓	✓	✓	✓	✓	✓	✓
	Power OFF Emergency* ³ (p. 2-18)	✓	✓	✓	✓	✓	✓	✓	✓
	Telephone* ¹ (p. 2-18)	N/A	N/A	N/A	N/A	N/A	✓	N/A	N/A
	Individual* ¹ (p. 2-18)	✓	✓	✓	✓	✓	✓	✓	✓
	Group* ¹ (p. 2-18)	✓	✓	✓	✓	✓	✓	✓	✓
	Call Alert (p. 2-18)	✓	✓	✓	N/A	N/A	N/A	✓	✓
	Status (p. 2-19)	✓	✓	✓	N/A	N/A	N/A	✓	✓
	Message (p. 2-19)	✓	✓	✓	N/A	N/A	N/A	✓	✓
	Write Message* ¹ (p. 2-19)	✓	✓	✓	N/A	N/A	N/A	N/A	✓
Trunking	Site Select* ¹ (p. 2-19)	N/A	N/A	✓	N/A	N/A	N/A	N/A	N/A
	Site Lock (p. 2-19)	N/A	N/A	✓	N/A	N/A	N/A	N/A	N/A
	Roaming Request (p. 2-19)	N/A	N/A	✓	N/A	N/A	N/A	N/A	N/A
Functions	Light* ² (p. 2-19)	✓	✓	✓	✓	✓	✓	✓	✓
	Lock (p. 2-19)	✓	✓	✓	✓	✓	✓	✓	✓
	Sp. Func 1/2/3/4/5/6 (p. 2-19)	✓	✓	✓	✓	✓	✓	✓	✓
	Public Address* ³ (p. 2-19)	✓	✓	✓	✓	✓	✓	✓	✓
	RX Speaker* ³ (p. 2-19)	✓	✓	✓	✓	✓	✓	✓	✓
	Hook Scan* ³ (p. 2-19)	✓	✓	✓	✓	✓	✓	✓	✓
	Horn* ³ (p. 2-20)	✓	✓	✓	✓	✓	✓	✓	✓
	VOX* ¹ (p. 2-20)	✓	✓	✓	✓	✓	✓	✓	✓
	Lone Worker (p. 2-20)	✓	✓	✓	✓	✓	✓	✓	✓
	Surveillance (p. 2-20)	✓	✓	✓	✓	✓	✓	✓	✓
	AquaQuake* ⁴ (p. 2-20)	✓	✓	✓	✓	✓	✓	✓	✓
	Ext.CH Sel Mode (p. 2-20)	✓	✓	✓	✓	✓	✓	✓	✓
	USB Mode Select* ¹ (p. 2-20)	✓	✓	✓	✓	✓	✓	✓	✓
	Keyset (p. 2-20)	✓	✓	✓	✓	✓	✓	✓	✓
	Zeroize (p. 2-20)	✓	✓	✓	✓	✓	✓	✓	✓

➤ Continued on the next page

✓: Applicable

N/A: Not Applicable

Depending on the transceiver's model type, some functions may not be assignable.

*¹ For only the Portable Ten-key type, Portable Simple key type, or Mobile LCD type transceivers.

*² For only the Portable Ten-key type, Portable Simple key type, Mobile LCD type or Mobile Segment type transceivers.

*³ For only Mobile type transceivers.

*⁴ For only Portable type transceivers.

*⁵ For only Portable Non-display type or Mobile Segment type.

2 PANEL DESCRIPTION

Assignable Software key functions

◇ For keys and keypads (Continued)

Category	Assignable function	Digital (NXDN)			Analog				
		Conventional	Single-site Trunk	Multi-site Trunk	2-Tone	5-Tone	LTR	MDC	BIIS
GPS	GPS ON/OFF (p. 2-21)	✓	✓	✓	✓	✓	✓	✓	✓
	GPS Position* ¹ (p. 2-21)	✓	✓	✓	✓	✓	✓	✓	✓
Voice Recording	Call Recorder (p. 2-21)	✓	✓	✓	✓	✓	✓	✓	✓
	Last Call Play (p. 2-21)	✓	✓	✓	✓	✓	✓	✓	✓
	Play Call Record* ¹ (p. 2-21)	✓	✓	✓	✓	✓	✓	✓	✓
	Play Emergency Call* ¹ (p. 2-21)	✓	✓	✓	✓	✓	✓	✓	✓
Audio Setting	TX Noise Cancel* ¹ (p. 2-21)	✓	✓	✓	✓	✓	✓	✓	✓
	RX Noise Cancel* ¹ (p. 2-21)	✓	✓	✓	✓	✓	✓	✓	✓
Bluetooth	Bluetooth (p. 2-21)	✓	✓	✓	✓	✓	✓	✓	✓
	Waiting Pairing* ¹ (p. 2-21)	✓	✓	✓	✓	✓	✓	✓	✓
Vibration* ⁴	Vibration* ⁴ (p. 2-21)	✓	✓	✓	✓	✓	✓	✓	✓
Display	Backlight* ¹ (p. 2-22)	✓	✓	✓	✓	✓	✓	✓	✓
	Brightness* ¹ (p. 2-22)	✓	✓	✓	✓	✓	✓	✓	✓
	Dimmer* ¹ (p. 2-22)	✓	✓	✓	✓	✓	✓	✓	✓
	LCD Mode* ¹ (p. 2-22)	✓	✓	✓	✓	✓	✓	✓	✓
Control Head Setting	Intercom* ³ (p. 2-22)	✓	✓	✓	✓	✓	✓	✓	✓

✓: Applicable

N/A: Not Applicable

Depending on the transceiver's model type, some functions may not be assignable.

*¹ For only the Portable Ten-key type, Portable Simple key type, or Mobile LCD type transceivers.

*² For only the Portable Ten-key type, Portable Simple key type, Mobile LCD type or Mobile Segment type transceivers.

*³ For only Mobile type transceivers.

*⁴ For only Portable type transceivers.

*⁵ For only Portable Non-display type or Mobile Segment type.

Assignable Software key functions

◇ For keys and keypads (Continued)

Disable

Set to disable the key.

NOTE: This key function is assignable to only [Ext. Emer].

Null

No function.

Menu

Push to display the “Menu” screen.

- ① Depending on the presetting, you may be able to make various calls, select various functions and adjust the transceiver settings in the Menu screen.
- ① In the Menu screen, you cannot use the assigned key functions.

Home

In the Analog mode

- Push to reset the destination station code to the default, if it has been manually changed.
- While in the Audible mode, push to return to the Inaudible mode and automatically send a reset code or Clear Down signal.

In the Digital mode

- Push to reset the destination Unit ID and call type to the default, if they have been manually changed.
- Push to cancel the Talk Back function, if it is activated.
- While in the Selection mode (Message, Status Message, and so on), hold down for 1 second to return to the Standby mode.
 - The transceiver resets the destination Unit ID, call type and Talk Back function to the default.
- While in the Multi-site Trunk channel, push to reset the Site Select setting.

Shift

1. Push to enter the Shift mode.
 - A user can use a Software key’s secondary function in the Shift mode.
2. Push this key again to return to the Normal mode.

Category: Channel/Scan (Voting)

CH Up, CH Down

- Push to select an operating channel.
- After pushing specific keys, push to select an option, setting, and so on.

Priority A, Priority B

Push to select the Priority A or Priority B channel.

Priority A (Rewrite), Priority B (Rewrite)

- Push to select the Priority A or Priority B channel.
- Hold down for 1 second to assign the operating channel to the Priority A or Priority B channel.

Zone Up, Zone Down

Push to select an operating zone.

Zone Select

Push to display the “Zone Select” screen. Then, push [Up] or [Down] to select a zone.

TIP: What is a “zone”?

Certain channels are grouped together and assigned to a zone according to their intended use. For example, ‘Staff A’ and ‘Staff B’ are assigned to a “Business” zone, and ‘John’ and ‘Cindy’ are assigned to a “Private” zone.

Scan Start/Stop

- Push to start or cancel a Scan.
 - ① When a scan started with the Power ON Scan or Auto Scan function, pushing this key pauses the scan. The paused scan resumes after the preset time period has passed.
- Hold down for 1 second to display the “Scan List” screen. Then push [Up] or [Down] to select a list.

NOTE: When Mode Dependent Scan is ON, a user may not be able to display the Scan list, depending on the presetting.

Assignable Software key functions

◇ For keys and keypads

Category: Channel/Scan (Voting) (Continued)

Scan Add/Del (Tag)

- Push to add a channel to, or delete it from the current Scan list.
 - When a channel is added to the current Scan list, the current Scan list text and “ON” are briefly displayed.
 - When a channel is deleted from the current Scan list, the current Scan list text and “OFF” are briefly displayed.
- You can add a channel to, or delete it from a selected Scan list.
 1. Hold down for 1 second to display the “Scan Tag” screen.
 2. Push [Up] or [Down] to select a list.
 3. Push [OK] to add a channel to, or delete it from the selected list.
 - When a channel is added to the selected Scan list, the current Scan list text and “ON” are briefly displayed.
 - When a channel is deleted from the selected Scan list, the current Scan list text and “OFF” are briefly displayed.
 4. Push [Back] to exit the “Scan Tag” screen.
- While a Scan is paused by detecting a signal on a channel (except for primary or secondary channel), push this key to remove the channel from the Scan list.

TIP: When the Nuisance Delete function is ON, the removed channel is automatically added to the Scan list again, after the Scan is canceled.

High/Low

Push to select the transmit output power level temporarily or permanently, depending on the presetting.

C.Tone CH Select

In the Analog mode

Push to display the “C.Tone CH Select” screen. Then push [Up] or [Down] to select a tone frequency or code. After selecting, push [OK] to save.

Tone/RAN CH Select

In the Analog mode

Push to display the “C.Tone CH Select” screen. Then push [Up] or [Down] to select a tone frequency or code. After selecting, push [OK] to save.

In the Digital mode

Push to display the “RAN CH Select” screen. Then push [Up] or [Down] to select a RAN code. After selecting, push [OK] to save.

Monitor

- Push to turn the CTCSS (DTCS), 2-Tone, or 5-Tone squelch mute ON or OFF.
 - ① Only during 2-Tone mode operation, push to open any squelch, or deactivate any mute functions.
 - ① Only during 5-Tone mode operation, push to activate one or two of the following functions on each channel (Depending on the presetting):
 - Hold down to unmute the channel (Audible mode).
 - Push to mute the channel (Inaudible mode).
- NOTE:** The audible (unmute) mode may automatically return to the Inaudible (mute) mode, after the preset time period.
- Depending on the presetting, holding down this key for 1 second may cancel the Scan.

Talk Around

Push to turn the Talk Around function ON or OFF.

- ① The Talk Around function equalizes the transmit frequency to the receive frequency, for direct (Simplex) communication.

Bandwidth

In the Analog mode

Push to temporarily set the channel width to Wide* or Narrow.

- ① The wide passband width can be preset to either 25.0 kHz (Wide) or 20.0 kHz (Mid). Depending on the presetting, Mid channel width may be selectable.

*The Wide channel width is not usable for the USA version transceivers.

Scrambler/Encryption

In the Analog mode

Push to turn the Voice Scrambler function ON or OFF.

- ① The Voice Scrambler function provides private communication between stations by using a scrambled code.

In the Digital mode

Push to turn the Encryption function ON or OFF.

- ① The Voice or Data Encryption function provides private communication between stations by using an Encryption Key and Key ID.

Compander

In the Analog mode

Push to turn the Compander function ON or OFF.

- ① The Compander function reduces noise components on the transmit audio to provide clear communication.

Assignable Software key functions

◇ For keys and keypads (Continued)

Category: Signaling/Call

Call

In the Analog mode

Push to make a call to the preset destination in the channel.

In the Digital mode

Hold down to send a Status, Message, or DTMF code to the preset destination in the channel. (For only Portable Non-display type or Mobile Segment type.)

Call A/Call B

In the Analog mode

Push to transmit a set 2/5-Tone code or BIIS Call Setup to the preset destination.

Re-dial

Push to send the last transmitted DTMF code number.
① Redial will be cleared when the transceiver is turned OFF once.

Call List Select

1. Push to display the "Call List" screen.
2. Push [Up] or [Down] to select an ID name (or ID code).
3. After selecting, push [OK] to set, and return to the Standby mode.

Call Menu

1. Push to display the "Call Menu" screen.
2. Push [Up] or [Down] to select an ID name (or ID code).
3. After selecting, push [OK] to set, and display the call function screen.
4. Push [Up] or [Down] to select a call function.
① See 'Transmitting a call' on sections 7 and 8 for details.
5. After selecting, push [PTT] to make a call to the selected station or group.

DTMF Autodial

- Push to display the "DTMF Autodial" screen. Then, push [Up] or [Down] to select a DTMF code. After selecting, push [PTT] to transmit the selected DTMF code.
- While in the Standby mode, hold down for 1 second to transmit the currently selected DTMF code.

Emergency

1. Hold down during the Emer SW ON Timer period to enter the Emergency mode.
2. After the Reminder Timer period has passed, an Emergency call is automatically transmitted once, or repeatedly.

NOTE:

- Set the related settings using the programming software.
- This key function is assignable to only [Emer] or [Ext. Emer].

- ① Hold down during the Emer SW OFF Timer period to cancel the Emergency function, before transmitting an Emergency call.

Power OFF Emergency

(For the Mobile type transceivers)

While holding down this key, turn OFF the transceiver to activate the Power OFF Emergency function.

NOTE: This key function is assignable to only [Emer] or [Ext. Emer].

① Information

- This function makes the transceiver transmit Emergency calls, even though it appears to be powered OFF.
- When the function is activated, any key operation, hanger action and Lone Worker function becomes invalid, as well as the Status indicator and speaker become the same as being powered OFF.
On the other hand, the transceiver can transmit Emergency calls according to the Emergency settings, and the Ambience Listening function is also activated, if it is set.
- To cancel the function and restore the transceiver, turn ON the transceiver.

Telephone

In the Analog mode

Push to toggle the telephone network connection capability.

Individual

Push to display the "Individual ID" screen. Then, push [Up] or [Down] to select an Individual ID name (or ID code).

After selecting, push [OK] to set.

Group

Push to display the "Group ID" screen. Then, push [Up] or [Down] to select an Group ID name (or ID code).

After selecting, push [OK] to set.

Call Alert

Hold down for 1 second to transmit a Call Alert.

Assignable Software key functions

◇ For keys and keypads

Category: Signaling/Call (Continued)

Status

Push to display the “Status List” screen. Then, push [Up] or [Down] to select a Status message. After selecting, push [PTT] to send the message to the currently selected station or group. Or, push [OK] to set.

① See pages 7-6, 8-14, 9-7 for details.

Message

While in the Standby mode, push to display the “Message List” screen. Then, push [Up] or [Down] to select a message.

After selecting, push [PTT] to send the message to the currently selected station or group.

① See pages 7-8, 8-16, 9-9 for details.

Write Message

Push to display the “Write Message” screen. After entering, push [PTT] to send the message to the currently selected station or group.

① See page 7-9, 9-11 for details.

Category: Trunking

Site Select

In the Digital mode

Push to display the “Site Select” screen. Then, push [Up] or [Down] to select a site number.

After selecting, push [OK] to set the selected site.

• The selected site is locked.

Site Lock

In the Digital mode

Push to turn the Site Lock function ON or OFF.

① When this function is turned ON, the transceiver cancels resuming a roaming scan, and stays on the current site, regardless of the error rate.

Roaming Request

In the Digital mode

Push to turn the Roaming Request function ON or OFF.

① When this function is turned ON, the transceiver starts or resumes a roaming scan, regardless of the error rate.

① When the Site Lock function is turned ON, pushing this key resumes a roaming scan.

Category: Functions

Light

Push to turn ON the backlight for about 5 seconds, even if the backlight setting is OFF.

Lock

Hold down for 1 second to turn the Key Lock function ON or OFF.

① All assignable keys except the following are electronically locked: [Monitor], [Light], [Lock], [Call], [Emergency], and [Surveillance]. Also, [PTT] and [Power] are usable.

Sp. Func 1, Sp. Func 2, Sp. Func 3, Sp. Func 4, Sp. Func 5, Sp. Func 6

Sp. Func 1 through Sp. Func 6 are reserved for PC commands.

Public Address (For the Mobile type transceivers)

Push to activate the Public Address (PA) function. And then, speak into the microphone while holding down [PTT].

① When the PA function is activated, the audio output can be separately controlled from the transceiver by pushing [Up] or [Down].

NOTE: This function is usable when an external unit, such as a audio amplifier, speaker, and so on is connected to the D-Sub 25 pin connector.

RX Speaker (For the Mobile type transceivers)

Push to turn the RX Speaker function ON or OFF.

① When the RX Speaker function is turned ON, the received audio can be heard through an external speaker that is connected to the D-Sub 25 pin connector.

NOTE:

- This function is usable when an external speaker is connected to the D-Sub 25 pin connector.
- This function is useful when a user is out of the vehicle.
- The audio output level is linked to the transceiver’s volume control.

Hook Scan (For the Mobile type transceivers)

Push to temporarily turn the Hook Scan function ON or OFF.

Assignable Software key functions

◇ For keys and keypads

Category: Functions (Continued)

Horn (For the Mobile type transceivers)

Push to turn the Horn function ON or OFF.

① When the Horn function is ON, the HORN terminal of the D-Sub 25 pin or Option Connector 22 pin is activated after receiving a call*.

*Only a call that the Dec EXO or RX EXO setting is ON.

① This function is useful when a user is away from the transceiver.

NOTE: This function is usable when an external speaker is connected to the D-Sub 25 pin connector.

VOX

Push to turn the VOX function ON or OFF.

① The function automatically switches between receive and transmit by detecting your voice.

NOTE:

- To use the function, a headset*¹ and a VOX converter cable are required (user supplied).
- When the VOX function is ON and using a third party Bluetooth headset, Synchronous Connection-Oriented (SCO) link*² is always connected.

*¹ Bluetooth headset is also usable.

*² A Bluetooth link for voice communication

Lone Worker

Push to turn the Lone Worker function ON or OFF.

① If no operation occurs during the specified period, the Lone Worker function automatically makes the transceiver enter the Emergency mode.

NOTE: To use the Lone Worker function, set the related settings using the programming software.

Surveillance

Push to turn the Surveillance function ON or OFF.

① When this function is turned ON, the beep is not heard and the backlight and the Status indicator do not light, even when a signal is received, or a key is pushed.

AquaQuake (For the Portable type transceivers)

While holding down this key, the AquaQuake water draining function removes water from the speaker grill by generating vibrations with the internal speaker.

• Water in the speaker grill may muffle the sound coming from the speaker.

NOTE:

- After the specified period of time, this function automatically stops, even if a user continues to hold down this key.
- This key works for only the internal speaker.

Ext.CH Sel Mode

Push to turn the Ext. CH Select function ON or OFF.

① When this function is ON, Memory channels are selected by only external entry.

NOTE:

- This function is activated when an external unit is connected to the transceiver.
- To use the function, set the input port function to "MCH Select:1" to "MCH Select: 5" to any pins, using the programming software.

USB Mode Select

Push to set the USB port mode to "Card Reader" or "Data Transfer."

Keyset

In the Digital mode

Push to select Keyset 1 or Keyset 2 for the Encryption function.

NOTE:

- To use the function, the optional UT-134 AES/DES ENCRYPTION UNIT is required.
- The Keysets are settable in the optional CS-KLD2 KEY LOADER SOFTWARE, and the Keysets are loaded into the UT-134 that is installed in the transceiver when doing the Key Load operation.

Zeroize

In the Digital mode

Push (Hold down*) to delete the Encryption Key of the UT-134 and transceiver.

After doing Zeroize, the user cannot use the Encryption function. To make the transceiver functional again, the keys must be reloaded.

* Non-display type transceivers operation

Assignable Software key functions

◇ For keys and keypads (Continued)

Category: GPS

GPS ON/OFF

Push to turn the GPS function ON or OFF.

- ① When this function is ON, the Latitude, Longitude, and Altitude data is displayed in the “My Position” screen.

NOTE: If the internal GPS receiver does not receive position data, no position data is displayed.

GPS Position

Push to display the “GPS Position” screen in the Menu mode.

- ① See page 6-11 for details.

Category: Voice Recording

Call Recorder

Push to start or stop the voice recording.

NOTE: This key is usable only when a microSD card is inserted into the transceiver’s card slot.

Last Call Play

NOTE: If you assign the key to the Portable Non-display type transceivers and Mobile Segment type transceivers, the Playing Back function can be used.

- Push to playback the last recorded audio file*.
- While playing back, push again to playback a previous file. When the oldest file is selected, by continuously pushing the key, push to return to the standby screen.
- While playing back, hold down to stop the playback and return to the standby screen.

* The file can be either a normal communication audio or an Emergency communication audio.

Play Call Record

Push to display the “Play Call Rec” screen.

- ① The screen displays the folders that contain recorded audio files.
- ① See page 11-5 for details.

NOTE: This key is usable only when a microSD card is inserted into the transceiver’s card slot.

Play Emergency Call

Push to display the “Play Emergency Call Rec” screen.

- ① The screen displays the folders that contain recorded audio files.
- ① See page 11-6 for details.

NOTE: This key is usable only when a microSD card is inserted into the transceiver’s card slot.

Category: Audio Setting

TX Noise Cancel

Push to select the TX Noise Cancel level between 1 and 3 to suppress the microphone input noise to make the audio easy to hear.

- ① When “OFF” is selected, the microphone input noise is not suppressed.

RX Noise Cancel

Push to select the RX Noise Cancel level between 1 and 3 to suppress the receive audio noise to make the audio easy to hear.

- ① When “OFF” is selected, the receive audio noise is not suppressed.

Category: Bluetooth

Bluetooth

Push to turn the Bluetooth® function ON or OFF.

Waiting Pairing

Push to enter the Pairing Request Wait mode.

- The transceiver waits for a pairing request from a Bluetooth® device.

Category: Vibration

Vibration (For the Portable type transceivers)

Push to turn the Vibration function ON or OFF.

- ① When “ON” is selected, the transceiver vibrates when a matching call or ID is received.

Assignable Software key functions

◇ For keys and keypads

Category: Display

Backlight

Push to select the Backlight level.

(For the Portable type transceivers)

- OFF: The backlight is continuously OFF.
- ON: Turns the backlight is continuously ON.
- Auto: When any switch except [PTT] is pushed, the backlight lights for 5 seconds.

(For the Mobile type transceivers)

- OFF: The backlight is continuously OFF.
- ON: Turns the backlight is continuously ON.
- Auto: Turns the backlight continuously ON with the Brightness setting level.
When the Dimmer terminal of the D-Sub 25 pin or Option Connector 22 pin is activated, the backlight lights dimly.

Brightness

Push to open the "Brightness" window. Then, push [Up] or [Down] to select the desired level between 0 (the lowest) and 7 (the highest).

Dimmer

Push to open the "Dimmer" window. Then, push [Up] or [Down] to select the desired level between 0 (the lowest) and 7 (the highest).

NOTE: It is recommended to be the Dimmer level lower than the Brightness level.

LCD Mode

Push to select the LCD Mode.

- Day : The LCD is set to the Day mode.
The Day mode is for the daytime operation, and the display backlight color is set to white.
- Night : The LCD is set to the Night mode.
The Night mode is for the nighttime operation, and the display backlight color is set to black.

Category: Control Head Setting

Intercom (For the Mobile type transceivers)

Push to turn the Intercom function ON or OFF.

The function enables communication between CONTROL HEAD 1 and CONTROL HEAD 2 during the dual-head operation using the optional RMK-7 or HM-218*.

* RMK-5 is required to connect to the transceiver.

NOTE: While communicating using the Intercom function, you can use only [PTT] and [VOL].

2 PANEL DESCRIPTION

Assignable Software key functions

◇ For the Lever switch (For the Portable type transceiver)

One of several functions can be assigned to the Lever switch.

When the Lever switch is slid to the “Φ” position, the assigned function is activated.

When the Lever switch is slid to the “O” position, the assigned function is deactivated.

NOTE: The function that is assigned to the Lever switch, cannot be assigned to any key.

Transceiver's top view

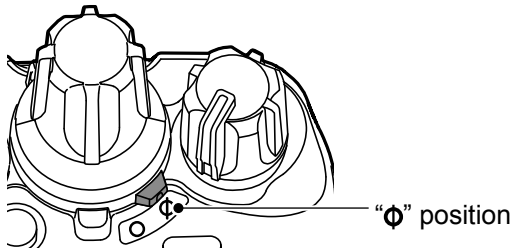

Assignable function	Digital (NXDN)			Analog				
	Conventional	Single-site Trunk	Multi-site Trunk	2-Tone	5-Tone	LTR	MDC	BIIS
Null (p. 2-24)	✓	✓	✓	✓	✓	✓	✓	✓
Backlight* (p. 2-24)	✓	✓	✓	✓	✓	✓	✓	✓
Lock (p. 2-24)	✓	✓	✓	✓	✓	✓	✓	✓
Scan Start/Stop (p. 2-24)	✓	✓	✓	✓	✓	✓	✓	✓
Talk Around (p. 2-24)	✓	✓	✓	✓	✓	✓	✓	✓
Scrambler/Encryption (p. 2-24)	✓	✓	✓	✓	✓	✓	✓	✓
Site Lock (p. 2-24)	N/A	N/A	✓	N/A	N/A	N/A	N/A	N/A
VOX (p. 2-24)	✓	✓	✓	✓	✓	✓	✓	✓
Lone Worker (p. 2-24)	✓	✓	✓	✓	✓	✓	✓	✓
Surveillance (p. 2-24)	✓	✓	✓	✓	✓	✓	✓	✓
Rotary Selector Shift (p. 2-24)	✓	✓	✓	✓	✓	✓	✓	✓
Individual/Group (p. 2-24)	✓	✓	✓	N/A	N/A	N/A	N/A	✓
LCD Mode* (p. 2-24)	✓	✓	✓	✓	✓	✓	✓	✓

✓: Applicable

N/A: Not Applicable

Depending on the transceiver's model type, some functions may not be assignable.

* For only the Ten-key type or Simple key type transceiver.

Assignable Software key functions

◇ For the Lever switch (For the Portable type transceiver) (Continued)

Null

No function.

Backlight

Turns the backlight ON or OFF, even if the Backlight setting is OFF.

Lock

Turns the Key Lock function ON or OFF.

- ① All assignable keys except the following are electronically locked: [Monitor], [Light], [Lock], [Call], [Emergency], [Surveillance], [PTT], and [Power].

Scan Start/Stop

Starts or cancels a scan.

- ① When a scan started with the Power ON Scan or Auto Scan function, slide the lever switch to pause the scan. The paused scan restarts after the preset time period has passed.

Talk Around

Turns the Talk Around function ON or OFF.

- ① The Talk Around function equalizes the transmit frequency to the receive frequency for transceiver-to-transceiver communication.

Scrambler/Encryption

In the Analog mode

Turns the Voice Scrambler function ON or OFF.

- ① The Voice Scrambler function provides private communication between stations.

In the Digital mode

Turn the Encryption function ON or OFF.

- ① The Voice or Data Encryption function provides private communication between stations by using an Encryption Key and Key ID.

Site Lock

Turns the Site Lock function ON or OFF.

- ① When this function is turned ON, the transceiver cancels resuming a roaming scan, and stays on the current site, regardless of the error rate.

VOX

Turns the VOX function ON or OFF.

- ① The function automatically switches between receive and transmit by detecting your voice.

NOTE: To use the function, a headset and a VOX converter cable are required (user supplied).

Lone Worker

Turns the Lone Worker function ON or OFF.

- ① If no operation occurs during the specified period, the Lone Worker function automatically makes the transceiver enter the emergency mode.

NOTE: To use the Lone Worker function, set the related settings using the programming software.

Surveillance

Turns the Surveillance function ON or OFF.

- ① When this function is turned ON, the beep is not heard and the backlight and the Status indicator do not light, even when a signal is received, or a key is pushed.

Rotary Selector Shift

Enters the [Selector]'s Shift mode.

- A user can use a [Selector]'s secondary function in the Shift mode.

Individual/Group

Sets the Call Type to Individual or Group.

LCD Mode

Sets the LCD Mode to Day or Night.

- ① The Day mode is for daytime operation, and the display backlight color is set to white.
- ① The Night mode is for nighttime operation, and the display backlight color is set to black.

Section 3

BASIC OPERATION

Turning ON the transceiver	3-2
◇ Adjusting the audio level	3-2
◇ Entering the password	3-2
Selecting a Zone.....	3-3
◇ Selecting a Zone	3-3
Selecting a channel	3-4
◇ Selecting an operating channel	3-4
◇ Selecting the Priority A or B channel.....	3-4
◇ Rewriting the Priority A or B channel	3-5
◇ Selecting a Continuous tone channel	3-5
◇ Selecting a RAN channel.....	3-6
Call procedure	3-7
Receiving and transmitting	3-8
◇ Transmitting notes	3-8
◇ Sending a call to a destination	3-9
Key Lock function	3-10

Turning ON the transceiver

NOTE: Before using the transceiver for the first time, the battery pack must be fully charged for optimum life and operation. See the INSTRUCTIONS for details.

Portable:

Rotate [VOL] to turn ON the transceiver.

- The battery voltage or the opening text may be displayed, depending on the presetting.

Mobile:

Push the Power key to turn ON the transceiver.

- The opening text may be displayed, depending on the presetting.

◇ Adjusting the audio level

When receiving a call, rotate [VOL] to adjust the audio output level to a comfortable listening level.

◇ Entering the password

Portable: For the Ten-key and the Simple key types

Mobile: For the LCD type

1. If the transceiver is preset for a Power ON password when turning ON the transceiver, the "User Password" screen is displayed, as shown to the right.
2. Push [Up], [Down], [Right], or [Left] to select a number, then push [OK] to enter.
3. Repeat step 2 to enter the password.
4. After entering the correct password, the transceiver automatically displays the standby screen.

NOTE: If the transceiver does not display the standby screen after entering the password, the entered code may be incorrect. In this case, push [Back] several times until you delete the incorrect code, and then enter the correct code.

TIP: For the Portable Ten-key type transceiver or optional HM-218, HM-220T, HM-221T, a user can enter the password with the keypad.

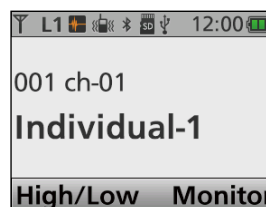
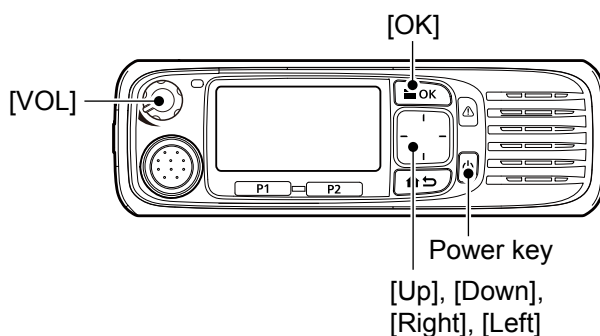
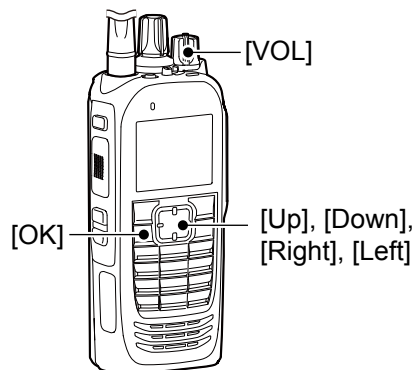

Standby screen

Selecting a Zone

◇ Selecting a Zone

Select a Zone type as shown:
 Conventional, Multi-site Conventional, LTR,
 Single-site Trunking, Multi-site Trunking or Voting

TIP: What is a “Zone”?

Certain channels are grouped together and assigned to a Zone according to their intended use. For example, ‘Staff A’ and ‘Staff B’ are assigned to a “Business” Zone, and ‘John’ and ‘Cindy’ are assigned to a “Private” Zone.

<Key or Selector operation>

Portable: For all types

Mobile: For all types

- Rotate [Selector]*. (Only the Portable type)
 *When “Zone” is assigned.
- Push [Zone Up] or [Zone Down].
- Push [Zone Select] to display the “Zone Select” screen. Then, push [Up] or [Down] to select a Zone. After selecting, push [OK].

NOTE: For the Mobile Segment type

To select a Zone, see “Selecting a channel” as described on page 3-4.

TIP: For the Portable Non-display type

Zones and Memory channels are assigned to a [Selector] position. Rotate [Selector], to set the assigned Zone and channel to be used.

<Menu operation>

Portable: For the Ten-key and the Simple key types

Mobile: For the LCD type

(Menu > Channel/Scan > **Zone Select**)

1. Push [Menu] to display the Menu screen.
2. Push [Left] or [Right] to select “Channel/Scan,” then push [OK].
3. Push [Up] or [Down] to select “Zone Select,” then push [OK].
 - Displays the “Zone Select” screen.

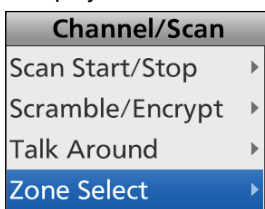

4. Push [Up] or [Down] to select a Zone, then push [OK].

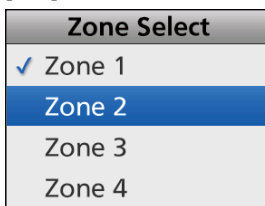

5. The selected Zone is displayed.

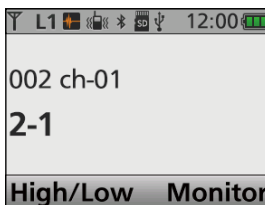

Selecting a channel

◇ Selecting an operating channel

<Key or Selector operation>

Portable: For all types

Mobile: For all types

- Rotate [Selector]. (Only the Portable type)
- Push [CH Up] or [CH Down].

TIP: For the Mobile Segment type

The number that is displayed on the screen is called a "position."

When the position number is selected by pushing [Up] or [Down], the assigned Zone and channel can be used.

Example: Zone 1/Channel 1 are assigned to position number 8.

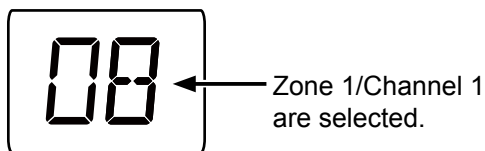

<Ten-key operation>

Portable: For the Ten-key type

Mobile: For the optional HM-218, HM-220T, or HM-221T HAND MICROPHONE

- Push the keypad to directly enter a channel number, depending on the presetting.
Example: Selecting Channel 2
 Push [0] → [0] → [2 ABC].

<Voting operation>

The transceiver automatically starts scanning when a Zone specified for the Voting operation is selected. The Voting scan detects the signal strength of the repeaters, and automatically selects the strongest one.

<Automatic Scan operation>

Depending on the presetting, when the user turns ON the transceiver, a scan automatically starts. The scan stops when a call is received.

◇ Selecting the Priority A or B channel

<Key operation>

Portable: For all types

Mobile: For all type

Push [Prio-A] or [Prio-B] to select the Priority A or Priority B channel.

<Menu operation>

Portable: For the Ten-key and the Simple key types

Mobile: For the LCD type

(Menu > Channel/Scan > **Priority A CH**)

(Menu > Channel/Scan > **Priority B CH**)

1. Push [Menu] to display the "Menu" screen.
2. Push [Left] or [Right] to select "Channel/Scan," then push [OK].

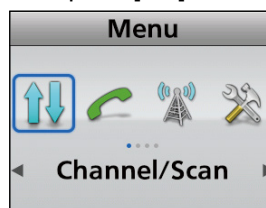

3. Push [Up] or [Down] to select "Priority A CH" or "Priority B CH," then push [OK].

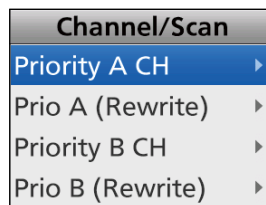

(Example: Priority A CH)

4. Hold down [Back] for 1 second to return to the standby screen.

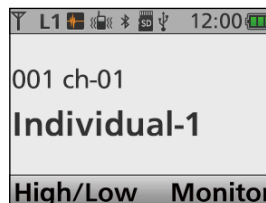

Selecting a channel

◇ **Rewriting the Priority A or B channel**

<Key operation>

Portable: For all types

Mobile: For all type

1. Select a channel to be set as the Priority A or B channel. (p. 3-4)
2. Hold down [Prio A (Rewrite)] or [Prio B (Rewrite)] for 1 second.
 - Sets the selected channel as the Priority A or B channel.

<Menu operation>

Portable: For the Ten-key and the Simple key types

Mobile: For the LCD type

(Menu > Channel/Scan > **Prio A (Rewrite)**)

(Menu > Channel/Scan > **Prio B (Rewrite)**)

1. Select a desired channel to be set as the Priority A or B channel. (p. 3-4)
2. Push [Menu] to display the “Menu” screen.
3. Push [Left] or [Right] to select “Channel/Scan,” then push [OK].

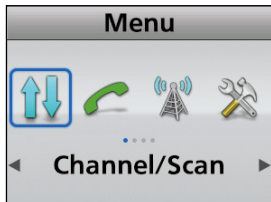

4. Push [Up] or [Down] to select “Prio A (Rewrite)” or “Prio B (Rewrite).”

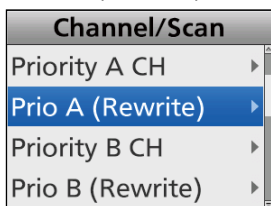

5. Push [OK].
 - Sets the selected channel as the Priority A or B channel.

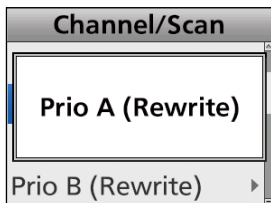

◇ **Selecting a Continuous tone channel**

<Key operation>

Portable: For the Ten-key and the Simple key types

Mobile: For the LCD type

1. While in the Analog mode, push [C.Tone CH Select] to display the “C.Tone CH Select” screen.
2. Push [Up] or [Down] to select a Continuous tone channel, then push [OK].
 - Sets the selected channel.

<Menu operation>

Portable: For the Ten-key and the Simple key types

Mobile: For the LCD type

(Menu > Channel/Scan > **C.Tone CH Select**)

1. While in the Analog mode, push [Menu] to display the “Menu” screen.
2. Push [Left] or [Right] to select “Channel/Scan,” then push [OK].

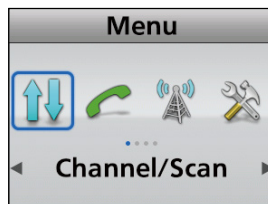

3. Push [Up] or [Down] to select “C.Tone CH Select,” then push [OK].
 - Displays the “C.Tone CH Select” screen.

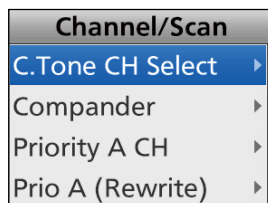

4. Push [Up] or [Down] to select a Continuous tone channel, then push [OK].
 - Sets the selected channel.

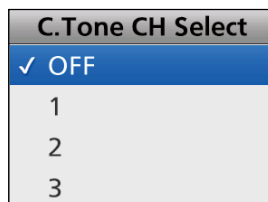

5. Hold down [Back] for 1 second to return to the standby screen.
 - The selected Continuous tone channel number is displayed.

Selecting a channel

◇ Selecting a RAN channel

<Key operation>

Portable: For the Ten-key and the Simple key types

Mobile: For the LCD type

1. While in the Digital mode, push [Tone/RAN CH Select] to display the “RAN CH Select” screen.
2. Push [Up] or [Down] to select a RAN channel, then push [OK].
 - Sets the selected channel.

<Menu operation>

Portable: For the Ten-key and the Simple key types

Mobile: For the LCD type

(Menu > Channel/Scan > **RAN CH Select**)

1. While in the Digital mode, push [Menu] to display the “Menu” screen.
2. Push [Left] or [Right] to select “Channel/Scan,” then push [OK].

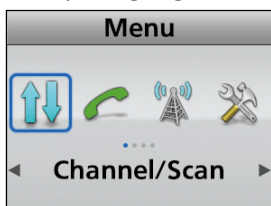

3. Push [Up] or [Down] to select “RAN CH Select,” then push [OK].
 - Displays the “RAN CH Select” screen.

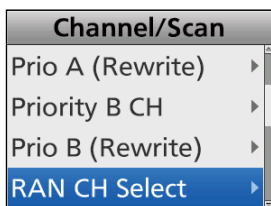

4. Push [Up] or [Down] to select a RAN channel, then push [OK].
 - Sets the selected channel.

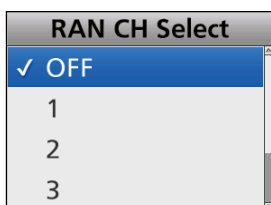

5. Hold down [Back] for 1 second to return to the standby screen.
 - The selected RAN channel number is displayed.

Call procedure

When your system uses tone signaling (except CTCSS and DTCS), a call procedure may be necessary prior to voice transmission. The tone signaling employed may be a selective calling system, which enables you to call only specific stations, and prevents unwanted stations from contacting you.

1. Select a channel according to your system operator's instructions.
 - This may not be necessary, depending on the presetting.
 - Refer to page 3-4 for details.
2. Push [Call].
3. After transmitting, the remainder of your communication can be carried out in the normal way.

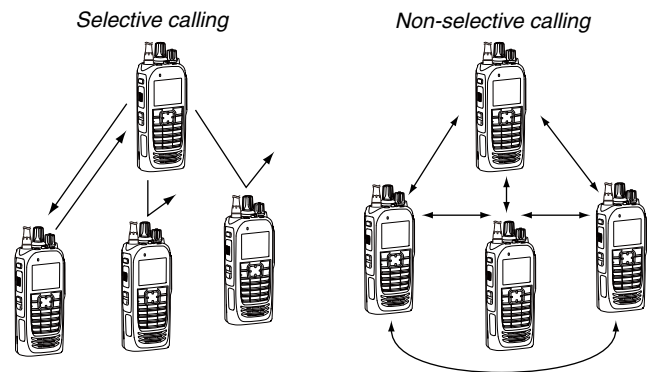

The illustration is of the Ten-key type transceivers.

Receiving and transmitting

CAUTION: DO NOT transmit without an antenna. It may damage the transceiver. See pages 1-3 and 2-6 for accessory attachments.

Receiving:

1. Turn ON the transceiver. (p. 3-2)
2. Select a channel. (p. 3-4)
3. When receiving a call, rotate [VOL] to adjust the audio output level to a comfortable listening level.

NOTE: Depending on the presetting, the transceiver may automatically transmit the microphone audio for the preset time period when a matching signal is received. (Auto TX function)

Transmitting:

Wait for the channel to become clear to avoid interference.

1. While holding down [PTT], speak at your normal voice level.
 - When a tone signaling system is used, the call procedure described on page 3-9 may be necessary.
2. Release [PTT] to return to receive.

IMPORTANT: To maximize the readability of your signal.

1. Pause briefly after pushing [PTT].
2. Hold the microphone 5 to 10 cm (2 to 4 inches) from your mouth, then speak at your normal voice level.

◇ Transmitting notes

Transmit inhibit function

The transceiver has several inhibit functions which restrict transmission under the following conditions:

- The channel is in the Inaudible mode (“”: Audible icon does not appear.)
- The channel is busy. However, depending on the presetting, you can transmit when a call is received that includes an non-matching (or matching) CTCSS (DTCS), RAN (Radio Access Number), Individual ID, or Group ID.
- The selected channel is a ‘receive only’ channel.

Time-out timer

If continuous transmission exceeds the preset time-out timer limit, the transmission is cut off.

Penalty timer

After the transmission is cut off by the Time-Out Timer, transmission is further inhibited for the preset penalty timer period.

Receiving and transmitting

◇ Sending a call to a destination

When a tone frequency (2-Tone) or code (5-Tone) is preset in the Call List, a user can select it as a destination.

<Key operation>

Portable: For the Ten-key and the Simple key types

Mobile: For the LCD type

1. Push [Call List Select] to display the “Call List Select” screen.

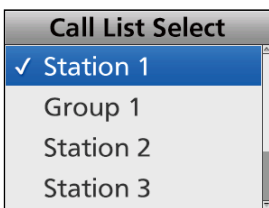

2. Push [Up] or [Down] to select a destination.
3. After selecting, push [OK].
 - Returns to the Standby screen.
4. Push [Call] to make a call to the selected destination.

<Menu operation>

Portable: For the Ten-key and the Simple key types

Mobile: For the LCD type

(Menu > Signaling/Call > Call List Select)

1. Push [Menu] to display the Menu screen.
2. Push [Left] or [Right] to select “Signaling/Call,” then push [OK].



3. Push [Up] or [Down] to select “Call List Select,” then push [OK].

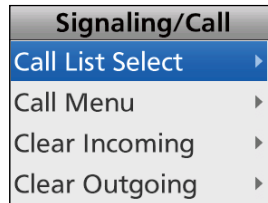

4. Push [Up] or [Down] to select a destination, then push [OK].
 - Sets the selected destination.

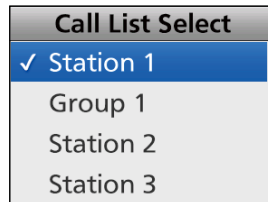

5. Hold down [Back] for 1 second to return to the standby screen.
6. Push [Call] to make a call to the selected destination.

Key Lock function

You can use the Key Lock function to prevent accidental channel changes and unnecessary function access.

① All assignable keys except the following are electronically locked: [Monitor], [Light], [Lock], [Call], [Emergency], and [Surveillance]. Also, [PTT] and [Power] are usable.

<Key operation>

Hold down for 1 second to turn the Key Lock function ON or OFF.

NOTE: The Key Lock function can be assigned to any key, only when it is NOT assigned to the Lever switch.

<Lever switch operation>

① The Lever switch can be used only when the Key Lock function is assigned to the Lever switch.

- Slide the Lever switch to the “ Φ ” position to turn ON the Key Lock function.
- Slide the Lever switch to the “O” position to turn OFF the Key Lock function.

Section 4

ADVANCED OPERATION

DTMF calls	4-2
◇ Manual Dialing	4-2
◇ Hot DTMF	4-2
◇ Autodial	4-2
◇ Stun function	4-2
Emergency call	4-3
◇ Transmitting an Emergency call	4-3
Scrambler	4-7
Radio Access Number (RAN)	4-7
AquaQuake™ Water Draining function (for the Portable type transceiver)	4-8

DTMF calls

◇ Manual Dialing

A user can send DTMF codes.

While holding down [PTT], push the keys on the Ten-key pad.

◇ Hot DTMF

A user can send DTMF codes using the Hot DTMF function.

Without holding down [PTT], push the keys on the Ten-key pad to send DTMF codes.

NOTE: Set the related settings using the CS-F3400D PROGRAMMING SOFTWARE when using the Hot DTMF function. See the Help file for details.

◇ Autodial

A user can quickly send DTMF tones that have been pre-entered into the transceiver.

1. Push [DTMF Autodial] to display the “DTMF Autodial” screen.

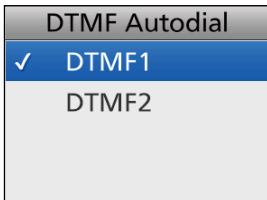

2. Push [Up] or [Down] to select a DTMF Memory.

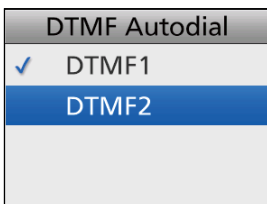

3. Push [PTT] to send the selected DTMF Memory's codes.
 - After sending, automatically returns to the standby screen.

TIP: In the standby screen, a user can send the currently selected DTMF Memory's codes by holding down [Autodial].

◇ Stun function

(Only for LTR operation)

The Stun function is used when a transceiver is stolen or lost, and the function deactivates the transceiver. When the transceiver receives a matching DTMF code, the stun function is activated and the transceiver operation is inhibited. In this case, entering the password or reprogramming is necessary to operate the transceiver again.

Emergency call

IMPORTANT: It is recommended that the dealer sets an Emergency channel in each zone, to provide a reliable Emergency call operation.

NOTE: Depending on the presetting, the following functions may be automatically activated.

Auto TX function

After an Emergency call transmission, the transceiver transmits the microphone audio for a preset period of time.

Auto RX function

After an Emergency call transmission, the transceiver stands by in the Audible mode for a preset period of time.

TIP: A user can transmit the Emergency call in the 2-Tone, 5-Tone, NXDN™, or MDC 1200 signaling system.

◇ **Transmitting an Emergency call**

When the transceiver enters the Emergency mode, a countdown starts. The transceiver counts down during the Reminder Timer set time.

Before the Reminder Timer set time expires, the transceiver transmits an Emergency call once, or repeatedly*, on the specified Emergency channel. If no Emergency channel is specified, the Emergency call is made on the previously selected channel.

* Depending on the presetting.

- ① The transceiver automatically transmits a repeat Emergency call until it receives an acknowledgement, or until a user turns OFF the transceiver.
- ① If the transceiver is set for Silent operation, it transmits an Emergency call without a beep sounding or the status indicator lighting.

The transceiver enters the Emergency mode through the following functions:

• **The [Emergency] key**

When a user holds down [Emergency] for the Emer SW ON Timer preset time.

- ① If a user holds down [Emergency] for the Emer SW OFF Timer set time before the Reminder Timer set time expires, the Emergency mode is canceled.

(Example)

- Emer SW ON Timer: 10 seconds
- Reminder Timer: 10 seconds

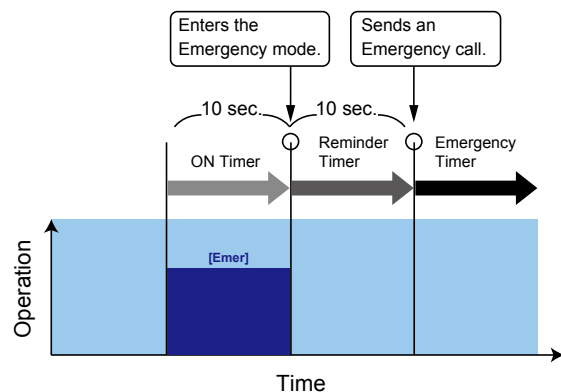

Emergency call

◇ Transmitting an Emergency call (Continued)

The transceiver enters the Emergency mode through the following functions:

• **The Man Down function**

When the transceiver leans past the preset angle for the ON Timer preset time.

- ① If a user raises the transceiver back from the preset angle towards the vertical position before the Reminder Timer set time expires, the Emergency mode is canceled.

(Example)

- ON Timer: 10 seconds
- Reminder Timer: 10 seconds
- Angle: 45 degrees

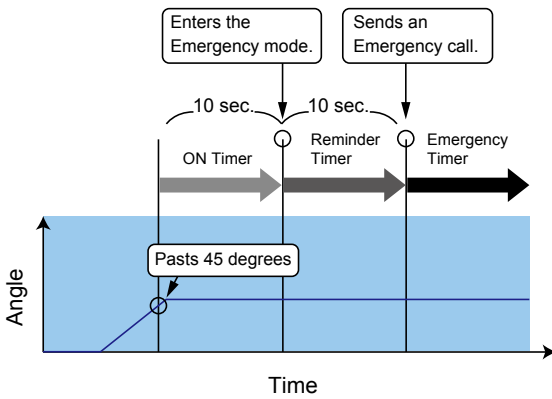

With Stationary

- The transceiver leans past the preset angle for the ON Timer preset time.
- AND
- The transceiver is detected as stationary (no motion) for the ON Timer set time.
- ① If a user raises the transceiver back from the preset angle towards the vertical position, or when the user moves the transceiver before the Reminder Timer set time expires, the Emergency mode is canceled.

(Example)

- ON Timer: 10 seconds
- Reminder Timer: 10 seconds
- Angle: 45 degrees

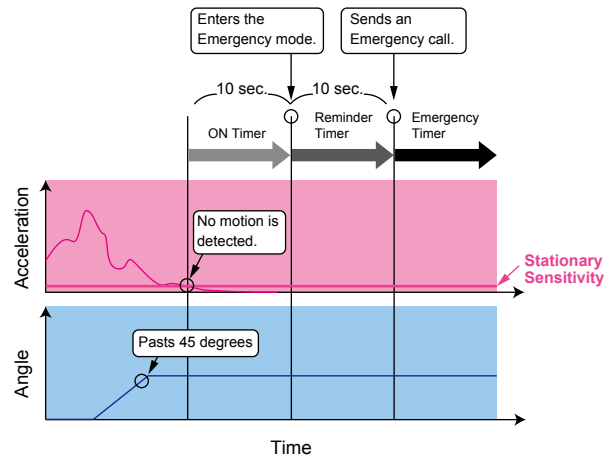

Emergency call

◇ Transmitting an Emergency call (Continued)

The transceiver enters the Emergency mode through the following functions:

• **The Lone Worker function**

When no operation occurs for the ON Timer preset time.

- ① If a user pushes any key before the Reminder Timer set time expires, the Emergency mode is canceled.

(Example)

- ON Timer: 60 minutes
- Reminder Timer: 60 seconds

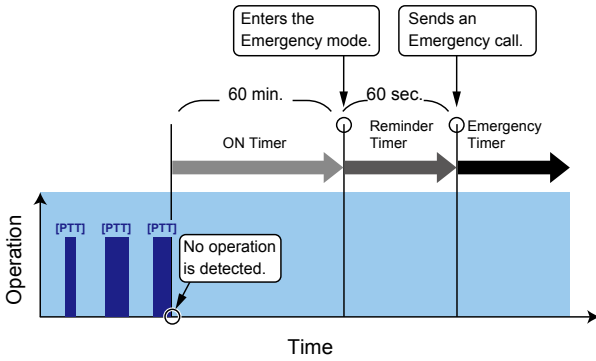

With Stationary

- When no operation occurs for the ON Timer preset time.
- AND
- The transceiver is detected as stationary (no motion) for the ON Timer set time.
- ① If a user pushes any key, or moves the transceiver before the Reminder Timer set time expires, the Emergency mode is canceled.

(Example)

- ON Timer: 60 minutes
- Reminder Timer: 60 seconds

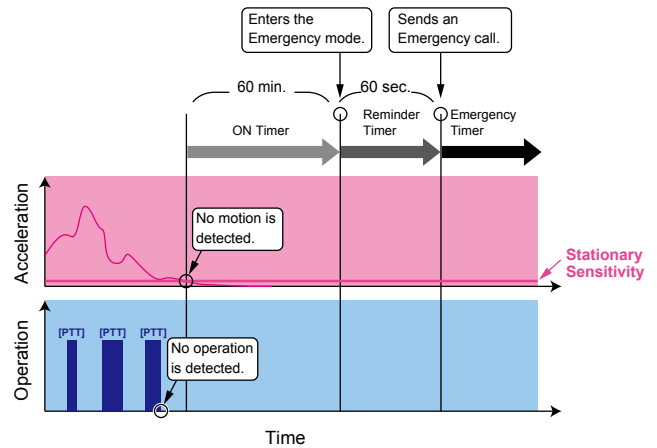

Emergency call

◇ Transmitting an Emergency call (Continued)

The transceiver enters the Emergency mode through the following functions:

• **The Stationary Detection function**

When the transceiver is detected as being stationary (no motion) for the ON Timer preset time.

- ① If a user moves the transceiver during the Reminder Timer set time, the Emergency mode is canceled.

(Example)

ON Timer: 60 seconds

Reminder Timer: 60 seconds

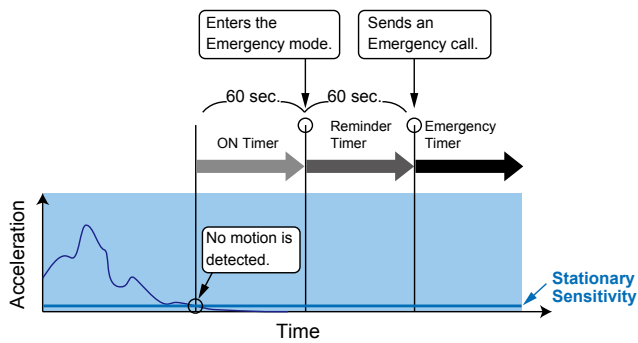

• **The Motion Detection function**

When the transceiver continuously moves for the ON Timer preset time.

- ① If a user holds down [Emergency] for the Emer SW OFF Timer set time, before the Reminder Timer set time expires, the Emergency mode is canceled.

(Example)

Motion Detection Timer: 10 seconds

Reminder Timer: 10 seconds

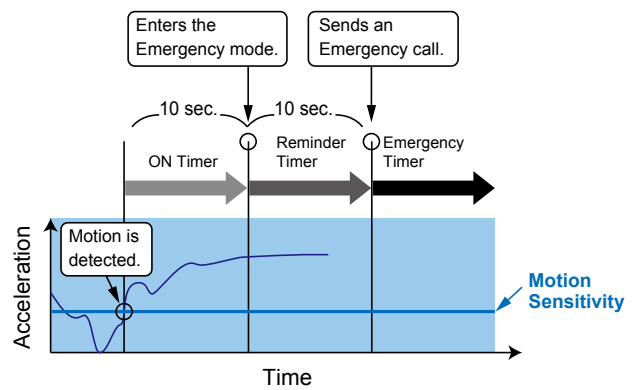

Scrambler

The Voice Scrambler function provides private communication between stations.

Push [Scrambler/Encryption] to toggle the Scrambler function ON or OFF.

- “” is displayed when the Scrambler function is ON.
- ① When the Scrambler function is ON, push [PTT] to make a private communication between stations by using a scrambled code.

Radio Access Number (RAN)

RAN is a signaling system designed for digital radio communications.

When a channel is set up with a RAN, the squelch will open only when a call containing a matching RAN is received.

If a call containing a different RAN is made on the same channel a user is using, a user will not hear the call.

AquaQuake™ Water Draining function (for the Portable type transceiver)

By vibrating the speaker, the AquaQuake Water Draining function clears water from the speaker grill to maintain clear audio.

1. Hold down [AquaQuake] to turn ON the AquaQuake water draining function.
 - A low frequency vibration is generating to remove water from the speaker grill.
 - Water in the speaker grill may muffle the sound coming from the speaker.
2. Release the key to turn OFF the function.

NOTE:

- After the specified period of time expires, this function automatically stops, even if a user continues to hold down this key.
- This key works for only the internal speaker.

Section 5 SCAN OPERATION

Starting a Scan	5-2
Canceling a Scan	5-3
Selecting a Scan list	5-4
Setting or clearing a Scan tag	5-5

Starting a Scan

A Scan checks for signals on each channel and stops when a signal is received.

NOTE: Two or more channels must be preset to start a Scan.

<Key operation>

Push [Scan Start/Stop] to start a Scan.

- “Z” blinks. (Depending on the transceiver’s version.)
- ① When a signal is detected, the Scan pauses on the channel until the signal disappears, and then the Scan resumes.

<Menu operation>

Portable: For the Ten-key and the Simple key types

Mobile: For the LCD type

(Menu > Channel/Scan > **Scan Start/Stop**)

1. Push [Menu] to display the Menu screen.
2. Push [Left] or [Right] to select “Channel/Scan,” then push [OK].

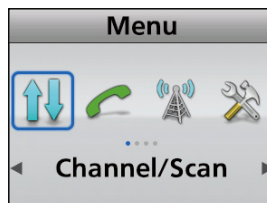

3. Push [Up] or [Down] to select “Scan Start/Stop,” then push [OK].



4. Push [Up] or [Down] to select “ON,” then push [OK].
 - The Scan starts.
 - ① When a signal is detected, the Scan pauses on the channel until the signal disappears, then the Scan resumes.

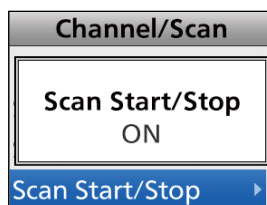
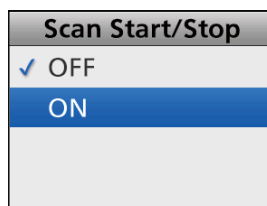

5. Hold down [Back] for 1 second to return to the standby screen.
 - “Z” blinks while scanning. (Depending on the transceiver’s version.)

Canceling a Scan

<Key operation>

While scanning, push [Scan Start/Stop] to stop a Scan.

- “” disappears. (Depending on the transceiver’s version.)

<Menu operation>

Portable: For the Ten-key and the Simple key types

Mobile: For the LCD type

(Menu > Channel/Scan > **Scan Start/Stop**)

1. Push [Menu] to display the Menu screen.
2. Push [Left] or [Right] to select “Channel/Scan,” then push [OK].

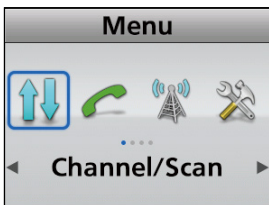

3. Push [Up] or [Down] to select “Scan Start/Stop,” then push [OK].

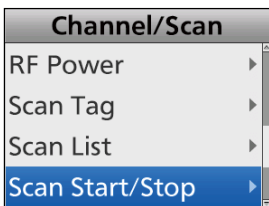

4. Push [Up] or [Down] to select “OFF,” then push [OK].
 - The Scan stops.
 - “Scan Start/Stop OFF” is briefly displayed.

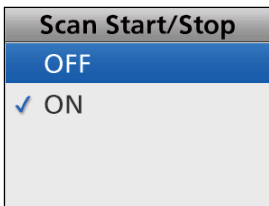

5. Hold down [Back] for 1 second to return to the standby screen.
 - “” disappears. (Depending on the transceiver’s version.)

Selecting a Scan list

You can select a Scan list to be scanned. Channels included in the selected Scan list are scanned during a scan. When selecting a zone type Scan list, the channels that are in the same zone as the Scan start channel will be scanned.

<Key operation>

Portable: For the Ten-key and the Simple key types

Mobile: For the LCD type

1. Hold down [Scan Start/Stop] for 1 second to display the "Scan List" screen.

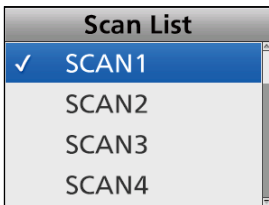

2. Push [Up] or [Down] to select a list, then push [OK].

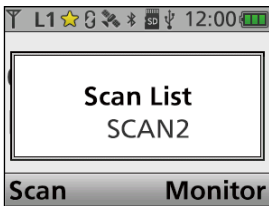
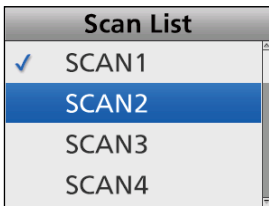

<Menu operation>

Portable: For the Ten-key and the Simple key types

Mobile: For the LCD type

(Menu > Channel/Scan > **Scan List**)

1. Push [Menu] to display the Menu screen.
2. Push [Left] or [Right] to select "Channel/Scan," then push [OK].

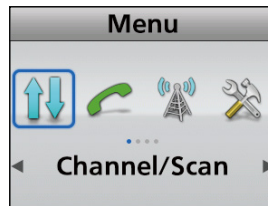

3. Push [Up] or [Down] to select "Scan List," then push [OK].
 - Displays the "Scan List" screen.

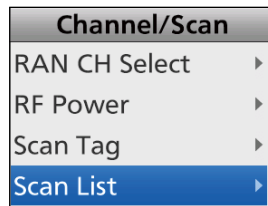

4. Push [Up] or [Down] to select a list, then push [OK].

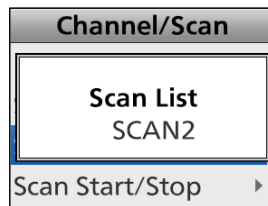
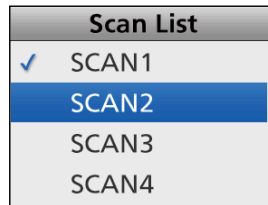

5. Hold down [Back] for 1 second to return to the standby screen.

Setting or clearing a Scan tag

You can set or clear a Scan tag to or from a channel in a Scan list.

The Scan tag channel is a target channel during a Scan.

<Key operation>

Portable: For the Ten-key and the Simple key types

Mobile: For the LCD type

In a current Scan list:

1. Select a channel. (p. 3-4)
2. Push [Scan Add/Del (Tag)] to set or clear a Scan tag to or from the channel.
 - "★" is displayed for a Scan tag channel.

When setting a Scan tag:

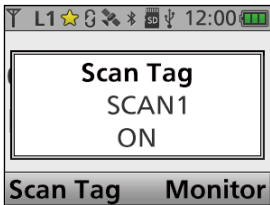

When clearing a Scan tag:

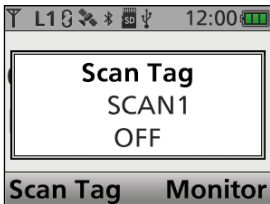

In a selected Scan list:

1. Select a channel. (p. 3-4)
2. Hold down [Scan Add/Del (Tag)] for 1 second to display the "Scan tag" screen.
3. Push [Up] or [Down] to select a Scan list.
4. Push [OK] to set or clear a Scan tag to or from the channel.

When setting a Scan tag:

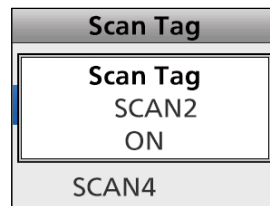
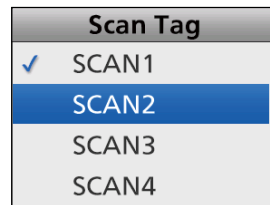

When clearing a Scan tag:

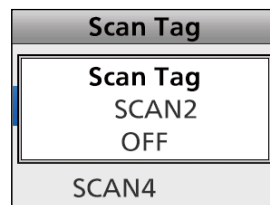
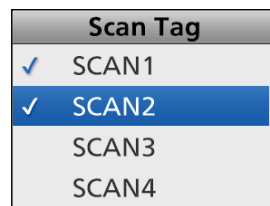

5. Hold down [Back] for 1 second to return to the standby screen.

Setting or clearing a Scan tag

<Menu operation>

Portable: For the Ten-key and the Simple key types

Mobile: For the LCD type

(Menu > Channel/Scan > **Scan tag**)

1. Select a channel. (p. 3-4)
2. Push [Menu] to display the Menu screen.
3. Push [Left] or [Right] to select "Channel/Scan," then push [OK].



4. Push [Up] or [Down] to select "Scan tag," then push [OK].
 - Displays the "Scan tag" screen.

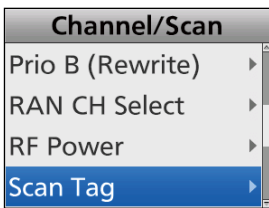

5. Push [Up] or [Down] to select a list, then push [OK].

When setting a Scan tag:

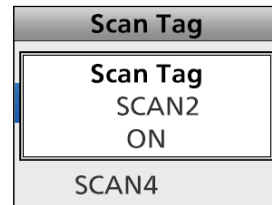
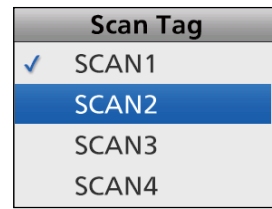

When clearing a Scan tag:

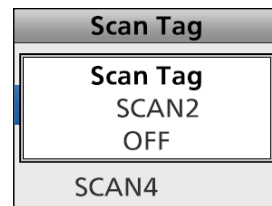
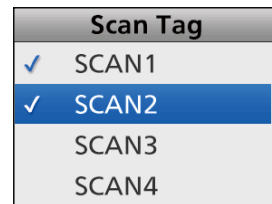

6. Hold down [Back] for 1 second to return to the standby screen.

Menu screen description	6-2
◇ Using the Menu screen.....	6-2
Menu items	6-3
Channel/Scan	6-8
Signaling/Call.....	6-9
Trunking.....	6-10
Functions	6-10
GPS	6-12
Voice Rec	6-13
Audio Setting	6-14
SD Card.....	6-15
Bluetooth	6-16
Clock.....	6-17
Vibration	6-17
Sensor	6-18
Display.....	6-18
Utility.....	6-19
Information.....	6-20
Control Head	6-21

Menu screen description

For only the Portable Ten-key type, Portable Simple key type, or Mobile LCD type transceivers, the user can open the “Menu” screen using the [Menu] key. In the “Menu” screen, the items are categorized. Depending on the presetting, the user can select various functions and set the transceiver settings in the “Menu” screen.

① The “Menu” screen has 2 display types: Icon type and List type. In this operating guide, the Icon type is used for the main illustration.

NOTE: The language displayed on the “Menu” screen is set to English by default, but a dealer can change it to another language using the programming software. In this case, the item names are displayed on the screen in the language set by the dealer, instead of English.

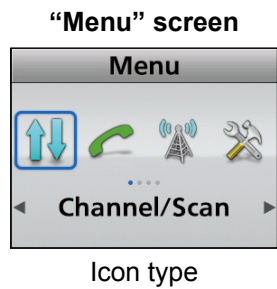

Icon type

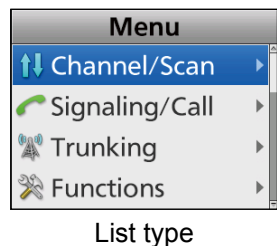

List type

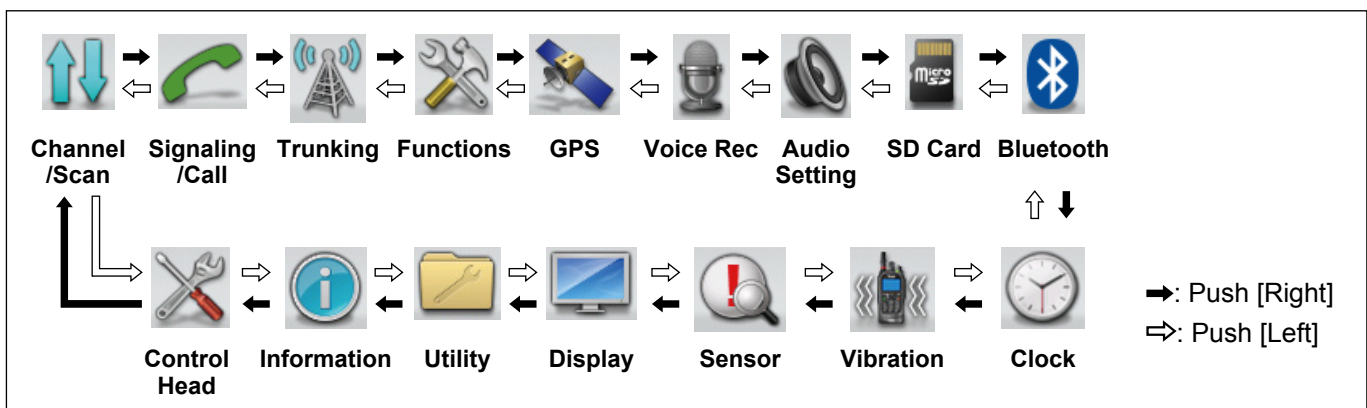

◇ Using the Menu screen

Example: Starting a Scan

1. Push [Menu] to display the Menu screen.
2. Push [Left] or [Right] to select “Channel/Scan,” then push [OK].

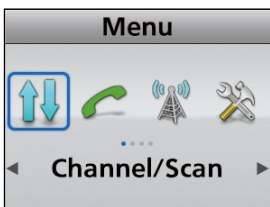

3. Push [Up] or [Down] to select “Scan Start/Stop,” then push [OK].

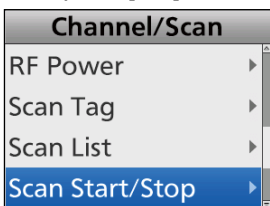

4. Push [Up] or [Down] to select “ON,” then push [OK].
 - The Scan starts.

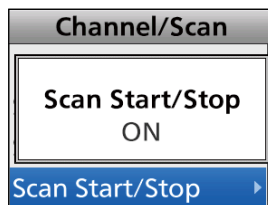
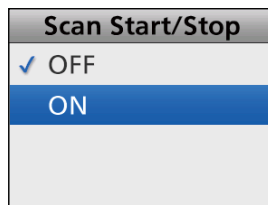

5. Hold down [Back] for 1 second to return to the standby screen.

Menu items

In the Menu screen, the items are categorized, as shown below.

Channel/Scan	C.Tone CH Select Sets the Continuous tone channel.	p. 6-8
	Compander Turns the Compander function ON or OFF.	p. 6-8
	Priority A CH Selects the Priority A channel.	p. 6-8
	Prio A (Rewrite) Sets a current channel as the Priority A channel.	p. 6-8
	Priority B CH Selects the Priority B channel.	p. 6-8
	Prio B (Rewrite) Sets a current channel as the Priority B channel.	p. 6-8
	RAN CH Select Sets the RAN channel.	p. 6-8
	RF Power Selects the output power for each channel.	p. 6-8
	Scan Tag (Scan Add/Del(Tag)) Sets or clears a Scan tag to or from a channel in a Scan list.	p. 6-8
	Scan List Sets a Scan list to be scanned.	p. 6-8
	Scan Start/Stop Starts or cancels a Scan.	p. 6-8
	Scramble/Encrypt (Scrambler/Encryption) Turns the Voice Scrambler or Encryption function ON or OFF.	p. 6-8
	Talk Around Turns the Talk Around function ON or OFF.	p. 6-8
	Zone Select Selects a Zone.	p. 6-8
Signaling/Call	Call List Select Selects a calling destination.	p. 6-9
	Call Menu Selects a calling destination and a call type.	p. 6-9
	Clear Incoming Clears the received call log from the Incoming list.	p. 6-9
	Clear Outgoing Clears the transmit call log from the Outgoing list.	p. 6-9
	DTMF Autodial Displays the "DTMF Autodial" screen. The preset DTMF codes are selectable.	p. 6-9
	Group Select Displays the "Group Select" screen. The preset Group IDs are selectable.	p. 6-9
	Incoming Displays a log of the received calls.	p. 6-9
	Individual Select Displays the "Individual Select" screen. The preset Individual IDs are selectable.	p. 6-9
	Message Displays the "Message" screen. The preset Messages are selectable.	p. 6-9
	Outgoing Displays a log of the transmit calls	p. 6-9

Continued on the next page

Menu items

Signaling/Call	Status Displays the "Status" screen. The preset Status messages are selectable.	p. 6-9					
	Write Message Enables the user to directly enter a message.	p. 6-9					
Trunking	Roaming Request Turns the Roaming Request function ON or OFF.	p. 6-10					
	Site Select Selects a site.	p. 6-10					
	Site Lock Turns the Site Lock function ON or OFF.	p. 6-10					
Functions	Ext CH Sel Mode Turns the External Channel Select mode ON or OFF.	p. 6-10					
	Hook Scan Turns the On Hook Scan function ON or OFF. (Mobile only)	p. 6-10					
	Horn Turns the Horn function ON or OFF. (Mobile only)	p. 6-10					
	Keypad Selects Keypad 1 or Keypad 2 for the Encryption function.	p. 6-10					
	Lone Worker Turns the Lone Worker function ON or OFF.	p. 6-10					
	Public Address Adjusts the Audio Output level of the connected Public Address (PA). (Mobile only)	p. 6-10					
	RX Speaker Turns the RX speaker function ON or OFF. (Mobile only)	p. 6-11					
	Surveillance Turns the Surveillance function ON or OFF.	p. 6-11					
	USB Mode Select Selects the USB port mode.	p. 6-11					
	VOX Turns the VOX function ON or OFF.	p. 6-11					
	VOX Delay Sets the VOX Delay.	p. 6-11					
	VOX Gain Sets the VOX gain.	p. 6-11					
GPS	Zeroize Disables the Encryption Key.	p. 6-11					
	GPS ON/OFF Turns the GPS function ON or OFF.	p. 6-12					
	GPS Position	<table border="1"> <tbody> <tr> <td>My Position</td> <td>Displays the transceiver's current position.</td> <td>p. 6-12</td> </tr> <tr> <td>RX List</td> <td>Displays the received call that includes position data.</td> <td>p. 6-12</td> </tr> </tbody> </table>	My Position	Displays the transceiver's current position.	p. 6-12	RX List	Displays the received call that includes position data.
My Position	Displays the transceiver's current position.	p. 6-12					
RX List	Displays the received call that includes position data.	p. 6-12					
Voice Rec	Call Recorder Starts or stops the audio recording.	p. 6-13					
	Play Call Rec (Play Call Record) Enables the user to play back the recorded audio on the microSD card.	p. 6-13					
	Play Emer Call (Play Emergency Call) Enables the user to play back the recorded emergency audio on the microSD card.	p. 6-13					

Continued on the next page

Menu items

Audio Setting	Mic Gain Sets the microphone sensitivity.	p. 6-14
	RX Noise Cancel Selects whether or not to suppress the receive audio noise to make the audio easy to hear.	p. 6-14
	TX Noise Cancel Selects whether or not to suppress the microphone input noise to make the audio easy to hear.	p. 6-14
	RX EQ Effect (RX Equalizer Effect) Selects the RX Equalizer Effect.	p. 6-14
	TX EQ Effect (TX Equalizer Effect) Selects the TX Equalizer Effect.	p. 6-14
SD Card	Load Setting <- SD Loads the transceiver's settings from a microSD card.	p. 6-15
	SD Unmount Unmounts a microSD card.	p. 6-15
	SD Format Formats the microSD card.	p. 6-15
	SD Information Displays the microSD card capacity and the time remaining for audio recording.	p. 6-15
	Software Update Updates the transceiver's firmware.	p. 6-15
Bluetooth	Bluetooth Turns the Bluetooth® function ON or OFF.	p. 6-16
	Bluetooth Reset Initializes the Bluetooth® unit.	p. 6-16
	Bluetooth Auto Connect Select whether or not to automatically connect to the paired Bluetooth® device when its power is turned ON.	p. 6-16
	Bluetooth Audio Setting Selects the AF Output device when a Bluetooth® headset is connected.	p. 6-16
	BT Device Info (Bluetooth Device Information) Displays the installed Bluetooth® unit name.	p. 6-16
	BT Device List (Bluetooth Device List) Displays the paired Bluetooth® devices.	p. 6-16
	Key Beep (VS-3) Sets the beep sound when the VS-3 Bluetooth® HEADSET Custom Key ([PLAY]/[FWD]/[RWD]) is pushed.	p. 6-16
	P.Save (VS-3) (Power Save(VS-3)) Selects whether to operate in the Bluetooth® headset's Battery Saving mode when the VS-3 Bluetooth® HEADSET is connected.	p. 6-16
	PTT Beep (VS-3) Sets the beep sound when [PTT] is pushed on the VS-3 Bluetooth® HEADSET.	p. 6-16
	One-touch PTT Sets the One-Touch PTT function when the Bluetooth® headset is connected.	p. 6-16
Waiting Pairing Enters the pairing request wait mode.	p. 6-16	

Continued on the next page

Menu items

Clock	Clock Adjust Sets the date and time.	p. 6-17
	Clock Auto Adjust Selects whether or not to automatically adjust the clock with data from the internal GPS receiver.	p. 6-17
	Clock Display Displays the current time on the transceiver's LCD.	p. 6-17
	DST (Daylight Saving Timer) Selects whether or not to use Daylight Saving Time (DST) for the clock.	p. 6-17
Vibration	Opening Vibration Selects whether or not to vibrate the transceiver when it is turned ON. (Portable only)	p. 6-17
	Vibration Turns the Vibration function ON or OFF. (Portable only)	p. 6-17
	Key Vibration Selects whether or not to vibrate the transceiver when a user pushes a key. (Portable only)	p. 6-17
Sensor	Man down Angle Sets the Emergency mode detection angle for the Man Down function. (Portable only)	p. 6-18
	Motion Sense Sets the acceleration sensor sensitivity to detect whether the user is moving or not, for the Motion Detection function. (Portable only)	p. 6-18
	Stationary Sense Sets the acceleration sensor sensitivity to detect if the user is stationary or not for the Stationary Detection function. (Portable only)	p. 6-18
Display	Backlight Sets the Key Backlight status.	p. 6-18
	Brightness Sets the LCD brightness level.	p. 6-18
	Dimmer Sets the LCD dimmer level.	p. 6-18
	LCD Color Test Checks whether or not the LCD displays color correctly.	p. 6-18
	LCD Mode Sets the LCD Mode.	p. 6-18

☞ Continued on the next page

Menu items

Utility	System Beep Lv (System Beep level) Sets the System Beep output level.	p. 6-19
	Emer Beep Lv (Emergency beep Level) Sets the Beep output level when in the Emergency mode.	p. 6-19
	Key-touch Beep Lv (Key-touch beep Level) Sets the Key-touch Beep output level.	p. 6-19
	Side Tone Lv (Side Tone beep Level) Set the Side Tone Beep output level.	p. 6-19
	Opening Beep Lv (Opening beep Level) Sets the Opening Beep output level.	p. 6-19
	Ringer Lv (Ringer beep Level) Sets the Ringer output level.	p. 6-19
	SQL Level (Squelch Level) Sets the squelch level.	p. 6-19
	Warning Beep Lv (Warning beep Level) Sets the Warning Beep output level.	p. 6-19
Information	Announce Lv (Announce beep Level) Sets the Beep output level for the Channel Announce function.	p. 6-19
	Battery Info (Battery Information) Displays the battery voltage.	p. 6-20
	Comment Displays the transceiver's comments.	p. 6-20
	Firmware Info (Firmware Information) Displays the transceiver's firmware information.	p. 6-20
	Own ID Displays the transceiver's unit ID.	p. 6-20
	RSSI/VER/MER Displays the transceiver's RSSI (Received Signal Strength Indication) level, VER (Vocoder Error Rate), and MER (Message Error Rate).	p. 6-20
Control Head	Intercom Turns the Intercom function ON or OFF. (Mobile only)	p. 6-21
	Hanger Turns the Hanger function ON or OFF. (Mobile only)	p. 6-21
	TX AF Monitor Turns the TX AF Monitor function ON or OFF. (Mobile only)	p. 6-21
	SP Link (Speaker Link) Turns the Speaker Link function ON or OFF. (Mobile only)	p. 6-21
	Primary Mic Selects which CONTROL HEAD's microphone to input the audio when using the Auto TX function or PC commands. (Mobile only)	p. 6-21
	Head SP Out (Head Speaker Output) Selects whether or not to output the audio from the CONTROL HEAD or an external speaker. (Mobile only)	p. 6-21

Channel/Scan

C.Tone CH Select

In the Analog mode

Sets the Continuous tone channel. (p. 3-5)

Compander

In the Analog mode

Turns the Compander function ON or OFF. This function reduces noise components on the transmit audio for clear communication.

Priority A CH

Selects the Priority A channel. (p. 3-4)

Prio A (Rewrite)

Sets a current channel as the Priority A channel. (p. 3-5)

Priority B CH

Selects the Priority B channel. (p. 3-4)

Prio B (Rewrite)

Sets a current channel as the Priority B channel. (p. 3-5)

RAN CH Select

In the Digital mode

Sets the RAN channel. (p. 3-6)

RF Power

Selects the output power for each channel.
• Options: Low 1, Low 2, High
① “Low 1” is the lowest power level, and “High” is the highest power level.
① Lower output power during short-range communications may reduce the possibility of interference to other stations.

Scan Tag

Sets or clears a Scan tag to or from a channel in a Scan list. (p. 5-6)

Scan List

Sets a Scan list to be scanned. (p. 5-4)

Scan Start/Stop

Starts or cancels a Scan. A Scan checks for signals on each channel and stops when a signal is received.

Scramble/Encrypt

In the Analog mode

Turns the Voice Scrambler function ON or OFF. This function enables private communication between stations using a Scramble code.

① The same Scramble code must be set in all stations to communicate.

In the Digital mode

Turns the Encryption function ON or OFF. This function enables private communication between stations using an Encryption Key and Key ID.

① The same Encryption Key and Key ID must be set in all stations to communicate.

Talk Around

Turns the Talk Around function ON or OFF. The Talk Around function equalizes the transmit frequency to the receive frequency, for direct (Simplex) communication.

Zone Select

Selects a Zone. (p. 3-3)

Signaling/Call

Call List Select

Selects a calling destination. After selecting, push [PTT] to transmit the voice call to the selected destination. (pp. 7-3, 7-4, 9-3, 9-5)

Call Menu

In the Analog mode

Selects a calling destination and a call type (Call Alert, Radio Check, Stun, Revive, and Sel Call). After selecting, push [PTT] to transmit the call to the selected destination. (pp. 8-5, 8-7, 8-9, 8-11, 8-13, 9-7, 9-9)

In the Digital mode

Selects a calling destination and a call type (Status, Message, Write Message, Call Alert, Remote Monitor, Radio Check, Stun, Revive, and Kill). After selecting, push [PTT] to transmit the call to the selected destination. (pp. 7-5, 7-7, 7-9 ~ 7-13)

NOTE: When the call type is “Status,” “Message,” or “Write Message,” you can select or directly enter a message before transmitting it. After selecting or entering a message, push [PTT] to transmit it. See pages 7-5, 7-7, and 7-9 for details.

Clear Incoming

In the Analog mode (BIIS)

In the Digital mode

Clears the received call log from the Incoming list. (pp. 7-22, 9-15)

Clear Outgoing

In the Digital mode

Clears the transmit call log from the Outgoing list. (p. 7-23)

DTMF Autodial

Displays the “DTMF Autodial” screen. Then, push [Up] or [Down] to select a DTMF code. After selecting, push [PTT] to transmit the selected DTMF code.

Group Select

Displays the “Group Select” screen. Then, push [Up] or [Down] to select a Group ID from the Call List. After selecting, push [PTT] to transmit a Group call. (p. 7-4)

Incoming

In the Analog mode (MDC/BIIS)

In the Digital mode

Displays a log of the received Individual call, Call Alert call, Status message, and Message. (pp. 7-20, 8-22, 9-14)

Individual Select

Displays the “Individual Select” screen. Then, push [Up] or [Down] to select a Individual ID from the Call List. After selecting, push [PTT] to send a Individual call. (p. 7-3)

Message

In the Analog mode (MDC/BIIS)

In the Digital mode

Displays the “Message” screen. Then, push [Up] or [Down] to select a message. After selecting, push [PTT] to send the Message to the currently selected destination. (pp. 7-8, 8-16, 9-9)

Outgoing

In the Digital mode

Displays a log of the transmitted Individual calls and Call Alert calls. (p. 7-21)

Status

In the Analog mode (MDC/BIIS)

In the Digital mode

Displays the “Status” screen. Then, push [Up] or [Down] to select a status message. After selecting, push [PTT] to send the message to the currently selected destination. (pp. 7-6, 8-14, 9-7)

Write Message

In the Analog mode (BIIS)

In the Digital mode

Enables the user to directly enter a message. After entering, push [PTT] to transmit it. (pp. 7-9, 9-11)

Trunking

Roaming Request

(For the Multi-site Trunk operation)

In the Digital mode

Turns the Roaming Request function ON or OFF. When this function is turned ON, the transceiver starts a Roaming Scan, regardless of the error rate. (p. 7-17)

① If the Site Lock function is turned ON, the transceiver resumes a Roaming Scan when this function is turned ON.

Site Select

(For the Multi-site Trunk operation)

In the Digital mode

Displays the "Site Select" screen. Then, push [Up] or [Down] to select a site. After selecting, push [OK] to save. (p. 7-19)

Site Lock

(For the Multi-site Trunk operation)

In the Digital mode

Turns the Site Lock function ON or OFF. When this function is turned ON, the transceiver cancels resuming a Roaming Scan, and stays on the current site, regardless of the error rate. (p. 7-18)

Functions

Ext CH Sel Mode

Turns the External Channel Select function ON or OFF. When this function is ON, Memory channels are selectable by only external input.

NOTE: This function is activated when the external unit is connected to the transceiver. To use the function, set "MCH Select:1" ~ "MCH Select:5" to any pins, in the Port Setting screen of the programming software.

Hook Scan (For the Mobile types)

Turns the On Hook Scan function ON or OFF. When this function is ON, after putting the microphone in its hanger (on-Hook), the transceiver automatically starts scanning.

Horn (For the Mobile types)

Turns the Horn function ON or OFF. When this function is ON, the HORN terminal of the D-Sub 25 pin or Option Connector 22 pin is activated after receiving a call with the Dec EXO or RX EXO setting is ON.

① This function is useful when the user is away from the transceiver.

② An external horn is required.

Keypad

In the Digital mode

Selects Keypad 1 or Keypad 2 for the Encryption function.

NOTE:

- To use the function, the optional UT-134 AES/DES ENCRYPTION UNIT is required.
- The Keypads are settable in the optional CS-KLD2 KEY LOADER SOFTWARE.

Lone Worker

Turns the Lone Worker function ON or OFF. When this function is ON, the transceiver automatically enters the Emergency mode if no operation occurs during the preset period.

Public Address (For the Mobile types)

Adjusts the Audio Output level of the connected Public Address (PA).

Functions

RX Speaker (For the Mobile types)

Turns the RX speaker function ON or OFF.
When this function is ON, the received audio can be heard through an external speaker that is connected to the D-Sub 25 pin connector.

NOTE:

- This function is usable when an external speaker is connected to the D-Sub 25 pin connector.
- This function is useful when a user is out of the vehicle.
- The audio output level is linked to the transceiver's volume control.

Surveillance

Turns the Surveillance function ON or OFF.
When this function is ON, beeps are not heard and the backlight and the Status indicator do not light, even when a signal is received, or a key is pushed.

USB Mode Select

Selects the USB port mode.

- Data Transfer: Used for setting up the transceiver, updating the firmware, or using the PC control command.
- Card Reader: Reads the inserted card contents.

VOX

Turns the VOX function ON or OFF.
When this function is ON, the receive and transmit are automatically switched by detecting the user's voice.

NOTE: To use the function, a headset* and a VOX converter cable are required (user supplied).
*Bluetooth headset is also usable.

VOX Delay

Sets the VOX Delay.
The VOX Delay is the period of time the transceiver continues transmitting after the user stops speaking, and then the VOX switches to receive.

- Range: 0.5 ~ 3.0 seconds

NOTE: If you set the time too short, a pause in a conversation may be regarded as the end of conversation, and the transceiver will start receiving, even as the conversation continues.

VOX Gain

Sets the VOX gain.
The VOX function automatically switches between receive and transmit by detecting the user's voice.

- Range: 1 ~ 10

① Higher values make the VOX function more sensitive to sounds.

Zeroize

In the Digital mode

Disables the Encryption Key.
After Zeroizing, the Encryption function is disabled until the transceiver is programmed again.

NOTE: When Zeroizing, both the Encryption Key in the transceiver, and the registered Encryption Key in the UT-134 are deleted.

GPS

GPS ON/OFF

Turns the GPS function ON or OFF.
When this function is ON, position data from the internal GPS receiver (Portable) or external GPS receiver (Mobile) is displayed in the "My Position" screen.

My Position

Displays the transceiver's current position.

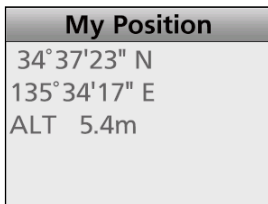

RX List

Displays the received call log that include position data. Push [Up] or [Down] to select the log, then push [OK].

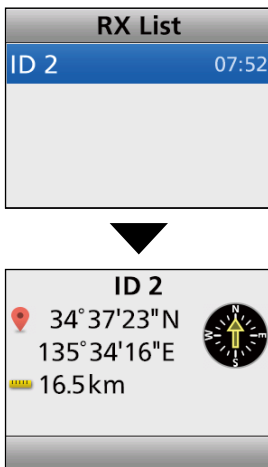

TIP: The transceiver may receive the position data with the Voice message, Status message, Message, Call Alert, or Emergency call.

Voice Rec

Call Recorder



microSD card is required

● Rec Start

Push [OK] to start the audio recording.

- “” is displayed.

① Information

- While holding down [PTT], “” blinks, and the communication audio is recorded.
- “” is displayed when the microSD card has no free space and cannot record audio.
- While recording, “Rec Stop” is displayed in the “Call Recorder” screen.
- Once the recording has started, the recording will continue, even if the transceiver is restarted.
- To stop the recording, select “Rec Stop.”

● Rec Stop

Push [OK] to stop the audio recording.

- “” disappears.

Play Call Rec

microSD card is required

Do the following steps to play back the recorded audio on the microSD card.

Select “Play Call Rec,” then push [OK] to display the folders on the microSD card.

- ① These folders contain the audio files.

Playing back

1. Push [Up] or [Down] to select the folder that includes the desired file to play back, then push [OK].
2. Push [Up] or [Down] to select the file to play back, then push [OK].
3. Push [Play] to play back.
 - The selected file is played back.
 - See page 11-5 for details.
4. Hold down [Back] for 1 second to return to the standby screen.

NOTE:

- The folder name is automatically created, as shown in the example below:
Recording date is 2016/7/1
Folder name: 20160701
- The file name is automatically created, as shown in the example below:
Recording date and time is 2016/7/1 15:30:00
File name: 20160701_153000
- The audio is recorded onto an microSD card, and saved in the “wav” format. (“wav,” is not displayed on the transceiver’s screen.)
- The recorded audio can also be played back with a PC. (p. 11-9)

Play Emer Call

microSD card is required

Do the following steps to play back the recorded Emergency audio on the microSD card.

Select “Play Emer Call,” then push [OK] to display the folders on the microSD card.

- ① These folders contain the audio files.

Playing back

1. Push [Up] or [Down] to select the folder that includes the desired file to play back, then push [OK].
2. Push [Up] or [Down] to select the file to play back, then push [OK].
3. Push [Play] to play back.
 - The selected file is played back.
 - See page 11-6 for details.
4. Hold down [Back] for 1 second to return to the standby screen.

NOTE:

- The folder name is automatically created, as shown in the example below:
Recording date is 2016/7/1
Folder name: 20160701
- The file name is automatically created, as shown in the example below:
Recording date and time is 2016/7/1 15:30:00
File name: 20160701_153000
- The audio is recorded onto an microSD card, and saved in the “wav” format. (“wav,” is not displayed on the transceiver’s screen.)
- The recorded audio can also be played back with a PC. (p. 11-9)

Audio Setting

Mic Gain

Sets the microphone sensitivity.

- Range: -8 (Minimum) ~ 5 (Maximum).
- ① Higher values make the microphone more sensitive to the user's voice.

RX Noise Cancel

Selects whether or not to suppress the receive audio noise to make the audio easy to hear.

- OFF: Turns OFF the function.
- 1, 2, or 3: Turns ON the function.
3 levels (1, 2, or 3) are selectable.
- ① Higher values suppress the audio noise more, but the audio quality becomes worse.

TX Noise Cancel

Selects whether or not to suppress the microphone input noise to make the audio easy to hear.

- OFF: Turns OFF the function.
- 1, 2, or 3: Turns ON the function.
3 levels (1, 2, or 3) are selectable.
- ① Higher values suppress the audio noise more, but the audio quality becomes worse.

RX Equalizer Effect

Selects the RX Equalizer Effect.

- Flat: Normal audio
- High Boost: Audio that emphasizes the high frequencies compared to "Flat"
- Mid Boost: Audio that emphasizes the midrange frequencies compared to "Flat"
- Low Boost: Audio that emphasizes the low frequencies compared to "Flat"
- Low Cut: Audio that cuts the low frequencies compared to "Flat"
- Custom: User customized audio

TX Equalizer Effect

Selects the TX Equalizer Effect.

- Flat: Normal audio
- High Boost: Audio that emphasizes the high frequencies compared to "Flat"
- Mid Boost: Audio that emphasizes the midrange frequencies compared to "Flat"
- Low Boost: Audio that emphasizes the low frequencies compared to "Flat"
- Low Cut: Audio that cuts the low frequencies compared to "Flat"
- Custom: User customized audio

SD Card

Load Setting <- SD

Loads the transceiver's settings from the microSD card.

① See "Loading the saved data files onto a microSD card" (p. 10-5) for details.

SD Unmount

Unmounts the microSD card.

NOTE: Before removing the microSD card, be sure to electrically unmount the card, when the transceiver is ON. Otherwise the data may be corrupted or deleted.

SD Format

Formats the microSD card.

If you use a brand new microSD card, be sure to format it.

① See "Formatting the microSD card" (p. 10-4) for details.

NOTE: Before using an microSD card with the transceiver, be sure to format all microSD cards with the built-in Format function. This creates a special folder on the card that you need for operations like updating the software. Format all cards, including a brand new microSD card, and even preformatted cards for PCs or other uses.

SD Information

Displays the microSD card capacity and the time remaining for voice recording.

① See "Displaying the information of the microSD card" (p. 10-6) for details.

Software Update

Updates the transceiver's firmware.

Bluetooth

Bluetooth

Turns the Bluetooth® function ON or OFF.

- OFF: Turns OFF the function.
- ON: Turns ON the function.

Bluetooth Reset

Initializes the Bluetooth® unit.

Only when the Bluetooth® function is OFF, initialization can be done

Bluetooth Auto Connect

Select whether or not to automatically connect to the paired Bluetooth® device when its power is turned ON.

- OFF: Does not connect to the paired device.
- ON: Automatically connects to the last connected device.

NOTE: The transceiver connects to the last connected device, if the connecting operation is performed on the device side, even if this item is set to OFF.

Bluetooth Audio Setting

Selects the AF Output device when a Bluetooth® headset is connected.

- BT Only: Sets the Bluetooth® headset as the AF Output device.
- BT & SP: Sets the Bluetooth® headset and the transceiver's speaker as the AF Output devices.

BT Device Info

Displays the installed Bluetooth® unit name, address, supported profile, and its version information.

BT Device List

Displays the paired Bluetooth® devices.

To find other Bluetooth® device, select "Find Device."

① See pages 11-6 and 11-9 for details.

Key Beep (VS-3)

Sets the beep sound when the optional VS-3 Bluetooth® HEADSET Custom Key ([PLAY]/[FWD]/[RWD]) is pushed.

- OFF: No beep sounds.
- ON: A beep sounds.

P.Save (VS-3)

Selects whether to operate in the Bluetooth® headset's Battery Saving mode when the optional VS-3 Bluetooth® HEADSET is connected. When the Power Save is activated, the user cannot use the VOX function.

NOTE: When a third-party headset or a data device is connected, this function is automatically set to OFF, even if this item is set to ON.

- OFF: Turns OFF the function.
- ON: The Power Save mode is enabled when no communication or operation is performed for 120 seconds.

PTT Beep (VS-3)

Sets the beep sound when [PTT] is pushed on the optional VS-3 Bluetooth® HEADSET.

- OFF: No beep sounds.
- ON: A beep sounds.

One-touch PTT

Sets the One-Touch PTT function when the Bluetooth® headset is connected. The function enables a user to transmit without continuously holding down [PTT].

NOTE: When a third-party headset is connected, this function may automatically be set to ON, even if this item is set to OFF.

- OFF: Push [PTT] to transmit, then release to receive.
- ON: Push [PTT] to transmit, then push again to receive.

Waiting Pairing

Enters the pairing request wait mode. The transceiver waits for a pairing request from a Bluetooth® device.

Clock

Clock Adjust

● **Date**

Sets the date (Year/Month/Day).

(The day of the week is automatically set.)

- Range: Year 2000 ~ 2099, Month/Day 1-1 ~ 12-31

● **Time**

Sets the current time.

(The time is displayed in the 24 hour format.)

- Range: 00:00:00 ~ 23:59:59 (in 1 second steps)

Clock Auto Adjust

Selects whether or not to automatically adjust the clock with data from the GPS receiver.

Clock Display

Displays the current time on the transceiver's LCD.

DST

Selects whether or not to use Daylight Saving Time (DST) for the clock.

Vibration

Opening Vibration (For the Portable types)

Selects whether or not to vibrate the transceiver when it is turned ON.

- ① To use this function, the Vibration function must be turned ON, in advance.

- OFF: Turns OFF the vibration.
- Pattern 01: The transceiver vibrates for 5 seconds.
- Pattern 02: The transceiver vibrates for 1 second three times.
- Pattern 03: The transceiver vibrates for 0.5 seconds four times.
- Pattern 04: The transceiver vibrates for 0.3 seconds eight times.
- Pattern 05 to 16: The transceiver vibrates, according to the customized pattern.

NOTE: You can customize the Vibration pattern, Vibration Repeat, and Interval time using the programming software.

Vibration (For the Portable types)

Turns the Vibration function ON or OFF.

To vibrate the transceiver, set each Vibration setting to ON using the programming software.

Depending on the Vibration setting, the transceiver may vibrate:

- When a call that includes a matching 2-Tone code is received.
- When a call that includes a matching 5-Tone code is received.
- When a Call Alert is received.
- When a Message is received.
- When a Status call that includes a matching status number is received.
- When a DTMF code is received.
- When a user pushes a key.
- While in the Low Battery 1 state.
- While in the Low Battery 2 state.
- While in the Surveillance mode.

Key Vibration (For the Portable types)

Selects whether or not to vibrate the transceiver when a user pushes a key.

- ① To use this function, the Vibration function must be turned ON, in advance.

Sensor

Man down Angle (For the Portable types)

Sets the Emergency mode detection angle for the Man Down function. If the transceiver leans past the set angle for the ON Timer time period, the transceiver enters the Emergency mode, and then a countdown starts.

- Options: 45, 60, or 75 degrees

Motion Sense (For the Portable types)

Sets the acceleration sensor sensitivity to detect whether the user is moving or not, for the Motion Detection function. This setting is for the Motion Detection function, and it determines the acceleration threshold level to activate the Motion Detection Timer.

- Range: 1 (high sensitivity) ~ 10 (low sensitivity).
- ① If you set a lower level, the transceiver will enter the Emergency mode more easily.

Stationary Sense (For the Portable types)

Sets the acceleration sensor sensitivity to detect if the user is stationary or not for the Stationary Detection function. This setting is used for the Stationary Detection function, and it determines the acceleration threshold level to activate the Stationary Detection's ON Timer (Sec).

- Range: 1 (high sensitivity) ~ 10 (low sensitivity).
- ① If you set at a higher level, the transceiver will enter the Emergency mode more easily.

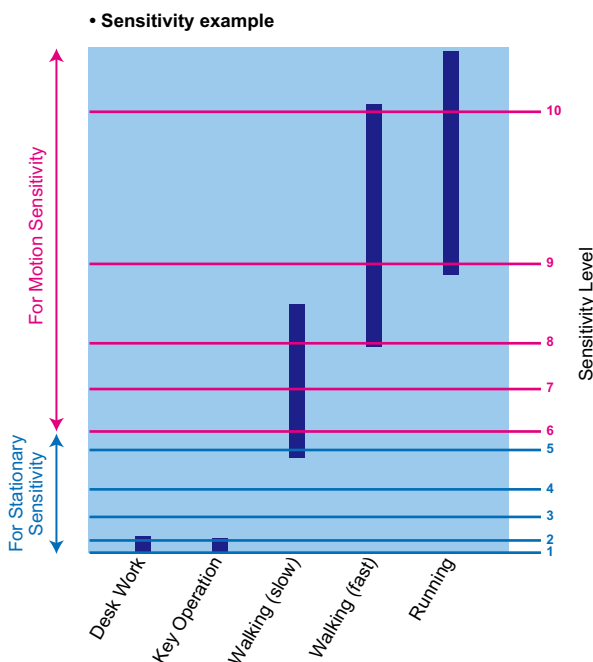

Display

Backlight

Sets the Key Backlight status.

For the Portable types

- OFF: Turns the display backlight continuously OFF.
- Auto: When any key except [PTT] is pushed, the backlight lights for 5 seconds.
- ON: Turns the backlight continuously ON.

For the Mobile types

- OFF: Turns the display backlight continuously OFF.
- Auto: Turns the backlight continuously ON with the Brightness setting level. When the Dimmer terminal of the D-Sub 25 pin or Option Connector 22 pin is activated, the backlight lights dimly with the Dimmer setting level.
- ON: Turns the backlight continuously ON with the Brightness setting level.

Brightness

Sets the LCD brightness level.

- Range: 0 (the lowest) ~ 7 (the highest)

Dimmer

Sets the LCD dimmer level.

- Range: 0 (the lowest) ~ 7 (the highest)

NOTE: It is recommended to be the Dimmer level lower than the Brightness level.

Language

Selects the language type used on the transceiver's display.

- English: The contents are displayed in English.
- Other: The contents are displayed in a language other than English.

LCD Color Test

Checks whether or not the LCD displays color correctly.

LCD Mode

Sets the LCD Mode.

- Day: The LCD is set to the Day mode. The Day mode is for daytime operation, and the display backlight color is set to white.
- Night: The LCD is set to the Night mode. The Night mode is for nighttime operation, and the display backlight color is set to black.

Utility

System Beep Lv

Sets the System Beep output level.
The beep sounds when connecting to or blocked from the System. When a Linked option is selected, the beep level is adjustable with [VOL].

- Range: 1 ~ 5, 1 (Linked) ~ 5 (Linked), or OFF

NOTE: The lockout timer and TOT beeps cannot be turned OFF.

Emer Beep Lv

Sets the Beep output level when in the Emergency mode.
When a Linked option is selected, the beep level is adjustable with [VOL].

- Range: 1 ~ 5, 1 (Linked) ~ 5 (Linked), or OFF

Key-touch Beep Lv

Sets the Key-touch Beep output level.
When a Linked option is selected, the beep level is adjustable with [VOL].

- Range: 1 ~ 5, 1 (Linked) ~ 5 (Linked), or OFF

Side Tone Lv

Set the Side Tone Beep output level.
2-Tone, 5-Tone or DTMF code signals are output as the Side Tone Beeps. When a Linked option is selected, the beep level can be adjusted with [VOL].

- Range: 1 ~ 5, 1 (Linked) ~ 5 (Linked), or OFF

Opening Beep Lv

Sets the Opening Beep output level.
When a Linked option is selected, the beep level is adjustable with [VOL].

- Range: 1 ~ 5, 1 (Linked) ~ 5 (Linked), or OFF

Ringer Lv

Sets the Ringer output level.
When a Linked option is selected, the Ringer level is adjustable with [VOL].

- Range: 1 ~ 5, 1 (Linked) ~ 5 (Linked), or OFF

SQL Level

Sets the squelch level.

- Range: 0 (open) ~ 9 (tight)

Warning Beep Lv

Sets the Warning Beep output level.
The Warning Beep sounds when:

- the battery is exhausted.
- an empty channel is selected.
- the Encryption key fails.

When a Linked option is selected, the beep level is adjustable with [VOL].

- Range: 1 ~ 5, 1 (Linked) ~ 5 (Linked), or OFF

Announce Lv

Sets the Beep output level for the Channel Announce function.
The transceiver announces the selected channel number.
When a Linked option is selected, the beep level is adjustable with [VOL].

- Range: 1 ~ 5, 1 (Linked) ~ 5 (Linked), or OFF

Information

Battery Info

Displays the battery voltage.

Comment

Displays the transceiver's comment.

The comment 1 is displayed on the first screen (Portable) or upper line (Mobile), and the comment 2 is on the second screen (Portable) or lower line (Mobile).

Firmware Info

Displays the transceiver's firmware information.

When an optional unit is installed, you can also check the unit information. Depending on the installed unit, only the name may be displayed.

Own ID

Displays the transceiver's unit ID.

RSSI/VER/MER

Displays the transceiver's RSSI (Received Signal Strength Indication) level, VER (Vocoder Error Rate), and MER (Message Error Rate), and Site ID*.

*Only in the Trunking channel.

Control Head

NOTE: These settings are settable only when connecting 2 control heads using the RMK-7 DUAL-HEAD SEPARATION KIT or HM-218 HAND MICROPHONE*.

* RMK-5 SEPARATION KIT is required to connect to the transceiver.

Intercom (For the Mobile types)

Turns the Intercom function ON or OFF. When this function is ON, the users can communicate each other through their control head's microphones.

① While communicating using the Intercom function, you can use only [PTT] and [VOL].

1. Select "Intercom," and then push [OK].
 - The Intercom function is ON.
2. Hold down or release [PTT] to communicate.
3. Push [OK] to turn the Intercom function OFF.

Hanger (For the Mobile types)

Selects which control head, or simply select both control heads, to automatically start scanning after putting the microphone in the hanger (on-Hook).

① To use this function, turn ON the Hook Scan function in the "Functions" category.

① Other Hanger actions can be set in the CS-F3400D PROGRAMMING SOFTWARE.

- HEAD 1 & HEAD 2: Automatically starts scanning after putting both microphones in their hangers.
- HEAD 1: Automatically starts scanning after putting the microphone in the CONTROL HEAD 1 hanger.
- HEAD 2: Automatically starts scanning after putting the microphone in the CONTROL HEAD 2 hanger.

TX AF Monitor (For the Mobile types)

Turns the TX AF Monitor function ON or OFF. When this function is ON, the user can monitor the audio that is transmitted on the other control head.

SP Link (For the Mobile types)

Turns the SP Link function ON or OFF. When this function is ON, the audio volume settings between the two control heads are linked.

- OFF: The audio volume settings are not linked, and are individually set at each control head.
- HEAD 1: The audio volume settings are linked, and are equally set on CONTROL HEAD 1.
- HEAD 2: The audio volume settings are linked, and are equally set on CONTROL HEAD 2.

Primary Mic (For the Mobile types)

Selects which control head's microphone to use when transmitting without pushing [PTT], such as when using the Auto TX function or PC commands.

- Options: HEAD 1, HEAD 2

Head SP Out (For the Mobile types)

Selects whether or not to output the audio from the control head.

- ① The user can individually set to each control head, and also the HM-218.
- OFF: The audio is not output from the control head's front speaker or from the HM-218.
- ON: The audio is output from the control head's front speaker or from the HM-218.

NXDN™ system operation	7-2
Transmitting a call	7-3
◇ Transmitting an Individual call.....	7-3
◇ Transmitting a Group call.....	7-4
◇ Transmitting a Status message	7-5
◇ Transmitting a Message.....	7-7
◇ Directly entering message	7-9
◇ Transmitting a Call Alert call	7-10
◇ Transmitting a Remote Monitor call	7-11
◇ Transmitting a Radio Check.....	7-11
◇ Transmitting a Stun command	7-12
◇ Transmitting a Revive command	7-12
◇ Transmitting a Kill command.....	7-13
◇ Transmitting an Emergency call	7-13
◇ Transmitting Position data	7-14
Receiving a call	7-15
◇ Receiving an Individual call	7-15
◇ Receiving a Group call.....	7-15
◇ Receiving a Status message	7-15
◇ Receiving a Message	7-15
◇ Receiving a Call Alert call	7-15
◇ Receiving a Radio Check call	7-15
◇ Receiving a Remote Monitor call	7-15
◇ Receiving a Stun, Kill or Revive.....	7-16
◇ Receiving an Emergency call	7-16
Roaming function (For the Multi-site Trunking operation).....	7-17
◇ Roaming Request function	7-17
Site Lock function (For the Multi-site Trunking operation)	7-18
Site Select function (For the Multi-site Trunking operation).....	7-19
Displaying the Incoming list.....	7-20
Displaying the Outgoing list.....	7-21
Deleting the Incoming list	7-22
Deleting the Outgoing list	7-23
Encryption function.....	7-24
Over The Air Programming function (OTAP)	7-25

NXDN™ system operation

NXDN is a new “Common Air Interface” (CAI), the name for over-the-air methods by which transceivers and repeaters communicate. NXDN defines the next-generation digital transceiver.

The NXDN system has two operating modes, Conventional and Trunking.

In an NXDN Conventional system, you manually search for an empty channel.

In an NXDN Trunking system, the transceiver automatically searches for an empty channel, and sends the information to the transceivers. In addition, a Control Channel repeater is required.

If you use an NXDN transceiver, you can transmit or receive an Individual Call, Group Call, Status Message, Short Message, Call Alert call, and so on.

● NXDN Conventional operation

The NXDN Conventional system enables efficient Conventional operation in the digital mode.

① To select the Conventional zone, see page 3-3.

● Multi-site Conventional operation

The Multi-site Conventional system can support up to 16 sites (each site has one repeater) through an IP network, and enables efficient Conventional operation in the digital mode.

① To select the Multi-site Conventional zone, see page 3-3.

● Single-site Trunking operation

The Single-site Trunking system enables further effective channel management by sharing a minimum number of channels with a large number of users.

① To select the Single-site Trunk zone, see page 3-3.

● Multi-site Trunking operation

The Multi-site Trunking system can support up to 48 trunked sites through an IP network. This enables the users to communicate with stations through the interlinked trunked site.

Each site can have up to 30 repeaters.

① To select the Multi-site Trunk zone, see page 3-3.

NOTE: During the Single-site or Multi-site Trunking operation, you can receive and transmit digital calls in the same way as in the Conventional mode.

Transmitting a call

NXDN operation enables you to make a call to a specific station (Individual call) or to a particular group (Group call). Other digital mode transceivers on the channel will not receive a call that does not match their Individual or Group ID and/or RAN (Radio Access Number) code.

NOTE: When the handshake (repeater access) fails within the specified time period after pushing [PTT], the transceiver starts roaming.

◇ Transmitting an Individual call

<Menu operation>

Portable: For the Ten-key and the Simple key types

Mobile: For the LCD types

(Menu > Signaling/Call > **Call List Select**)

1. Push [Menu] to display the Menu screen.
2. Push [Left] or [Right] to select "Signaling/Call," then push [OK].

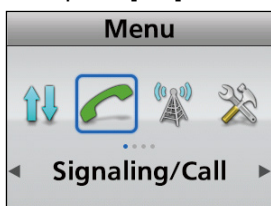

3. Push [Up] or [Down] to select "Call List Select," then push [OK].

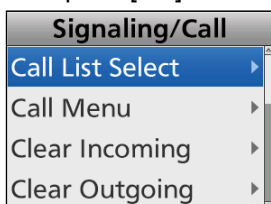

4. Push [Up] or [Down] to select the Individual station.

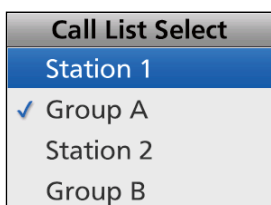

5. Push [PTT] to transmit an Individual call.
6. Hold down [PTT] and speak at your normal voice level. Release [PTT] to receive.

TIP:

- You can transmit an Individual call through the Call Menu. (Menu > Signaling/Call > **Call menu**)
- When an Individual ID is programmed in the Memory CH, you can transmit the Individual call by pushing [PTT] on the channel.

<Key operation>

Portable: For the Ten-key and the Simple key types

Mobile: For the LCD types

Using [Call List Select]:

1. Push [Call List Select] to display the "Call List Select" screen.

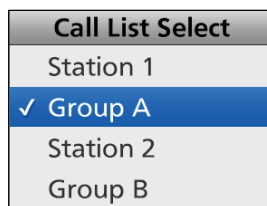

2. Push [Up] or [Down] to select the Individual ID.

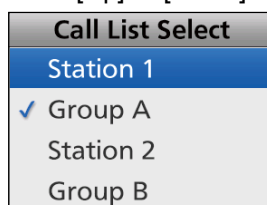

3. Push [PTT] to transmit an Individual call.
4. Hold down [PTT] and speak at your normal voice level. Release [PTT] to receive.

Using [Individual]:

1. Push [Individual] to display the "Individual Select" screen.

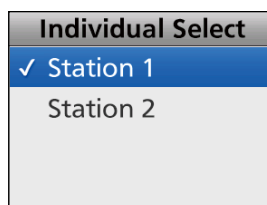

2. Push [Up] or [Down] to select the Individual station.

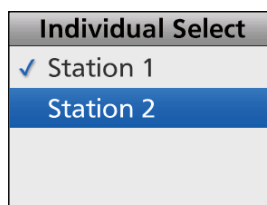

3. Push [PTT] to transmit an Individual call.
4. Hold down [PTT] and speak at your normal voice level. Release [PTT] to receive.

TIP: You can display the "Individual Select" screen through the Menu screen.

(Menu > Signaling/Call > **Individual Select**)

Transmitting a call

◇ **Transmitting a Group call**

You can call a specified group.

<Menu operation>

Portable: For the Ten-key and the Simple key types

Mobile: For the LCD types

(Menu > Signaling/Call > **Call List Select**)

1. Push [Menu] to display the Menu screen.
2. Push [Left] or [Right] to select “Signaling/Call,” then push [OK].

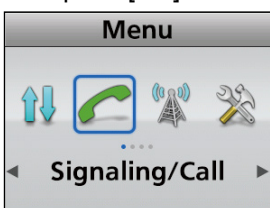

3. Push [Up] or [Down] to select “Call List Select,” then push [OK].

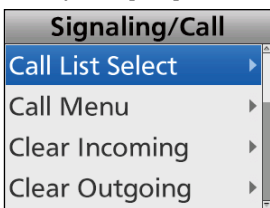

4. Push [Up] or [Down] to select the Group ID.

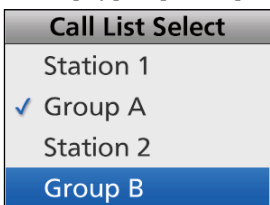

5. Push [PTT] to transmit a Group call.
6. Hold down [PTT] and speak at your normal voice level. Release [PTT] to receive.

TIP:

- You can transmit a Group call through the Call Menu. (Menu > Signaling/Call > **Call menu**)
- When a Group ID is programmed in the Memory CH, you can transmit the Talkgroup call by pushing [PTT] on the channel.

<Key operation>

Portable: For the Ten-key and the Simple key types

Mobile: For the LCD types

Using [Call List Select]:

1. Push [Call List Select] to display the “Call List Select” screen.

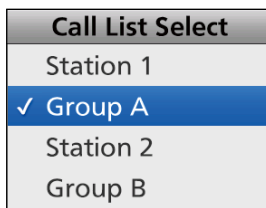

2. Push [Up] or [Down] to select the Group ID.

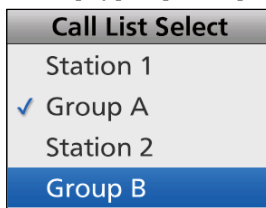

3. Push [PTT] to transmit a Group call.
4. Hold down [PTT] and speak at your normal voice level. Release [PTT] to receive.

Using [Group]:

1. Push [Group] to display the “Group Select” screen.
2. Push [Up] or [Down] to select the Group ID.

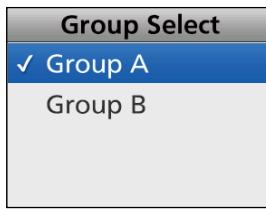

3. Push [PTT] to transmit a Group call.
4. Hold down [PTT] and speak at your normal voice level. Release [PTT] to receive.

TIP: You can display the “Group Select” screen through the Menu screen. (Menu > Signaling/Call > **Group Select**)

Transmitting a call

◇ **Transmitting a Status message**

You can transmit a preset simple message. You cannot transmit a voice signal at the same time.

<Menu operation>

Portable: For the Ten-key and the Simple key types

Mobile: For the LCD types

(Menu > Signaling/Call > **Call Menu**)

1. Push [Menu] to display the Menu screen.
2. Push [Left] or [Right] to select "Signaling/Call," then push [OK].

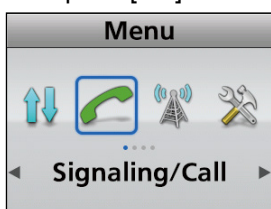

3. Push [Up] or [Down] to select "Call Menu," then push [OK].

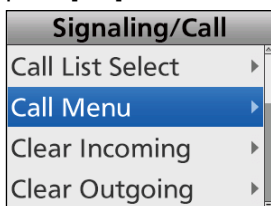

4. Push [Up] or [Down] to select the Individual or Group ID, then push [OK].

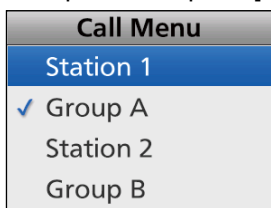

5. Push [Up] or [Down] to select "Status," then push [OK].

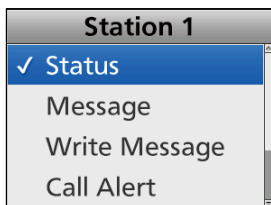

6. Push [Up] or [Down] to select a Status Message, then push [PTT] to transmit a Status call.

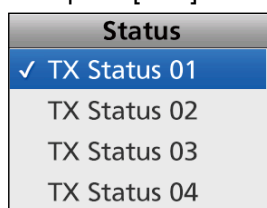

- ① "Success" is displayed after receiving an acknowledgement from the target station.
- ② "Failed" is displayed if the target station does not send back an acknowledgement.

(Menu > Signaling/Call > **Status**)

1. Push [Menu] to display the Menu screen.
2. Push [Left] or [Right] to select "Signaling/Call," then push [OK].
3. Push [Up] or [Down] to select "Status," then push [OK].

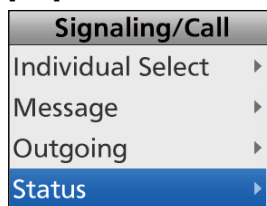

4. Push [Up] or [Down] to select a Status Message, then push [PTT] to transmit a Status call to the currently selected destination.

- ① "Success" is displayed after receiving an acknowledgement from the target station.
- ② "Failed" is displayed if the target station does not send back an acknowledgement.

Transmitting a call

◇ Transmitting a Status message (Continued)

<Key operation>

Portable: For the Ten-key and the Simple key types

Mobile: For the LCD types

Using [Status]:

1. Push [Status] to display the “Status” screen.

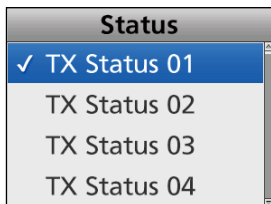

2. Push [Up] or [Down] to select a Status Message, then push [PTT] to transmit it.

- ① “Success” is displayed after receiving an acknowledgement from the target station.
- ① “Failed” is displayed if the target station does not send back an acknowledgement.

Portable: For All types

Mobile: For All types

Using [Status]:

Hold down [Status] for 1 second transmit the preset Status Message.

TIP: This operation is enabled only when [Selector]'s operation is set to “Status” using the programming software.

NOTE: The status message can be automatically transmitted when:

- The transceiver is turned ON or OFF
 - ① Set the Status message to be transmitted in ‘Power ON Status’ or ‘Power OFF Status’ item, respectively.
 - ① Set the target station ID in ‘Power Status ID,’ ‘Power Status ID for Single-site Trunk’ or ‘Power Status ID for Multi-site Trunk.’
- After sending a voice message
 - ① Set the ‘Send with Voice Call’ item to ‘Enable.’
 - ① Set the Status message to be transmitted in ‘Send Status Number’ item.

Transmitting a call

◇ **Transmitting a Message**

You can transmit a message of up to 100 characters.

<Menu operation>

Portable: For the Ten-key and the Simple key types

Mobile: For the LCD types

(Menu > Signaling/Call > **Call Menu**)

1. Push [Menu] to display the Menu screen.
2. Push [Left] or [Right] to select "Signaling/Call," then push [OK].

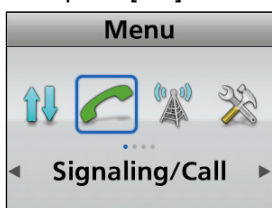

3. Push [Up] or [Down] to select "Call Menu," then push [OK].

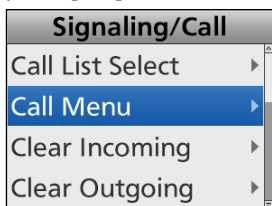

4. Push [Up] or [Down] to select the Individual or Group ID, then push [OK].

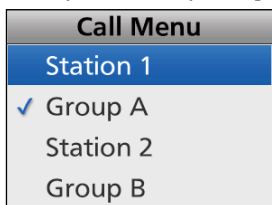

5. Push [Up] or [Down] to select "Message," then push [OK].

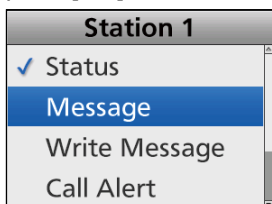

6. Push [Up] or [Down] to select a Message, then push [PTT] to transmit it.

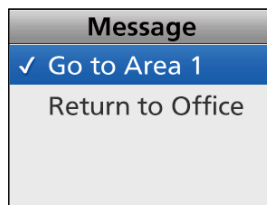

- ① "Success" is displayed after receiving an acknowledgement from the target station.
- ② "Failed" is displayed if the target station does not send back an acknowledgement.

(Menu > Signaling/Call > **Message**)

1. Push [Menu] to display the Menu screen.
2. Push [Left] or [Right] to select "Signaling/Call," then push [OK].
3. Push [Up] or [Down] to select "Message," then push [OK].

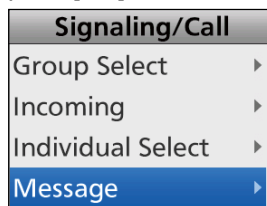

4. Push [Up] or [Down] to select a Message, then push [PTT] to transmit it to the currently selected destination.

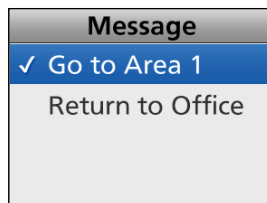

- ① "Success" is displayed after receiving an acknowledgement from the target station.
- ② "Failed" is displayed if the target station does not send back an acknowledgement.

Transmitting a call

◇ Transmitting a Message (Continued)

<Key operation>

Portable: For the Ten-key and the Simple key types

Mobile: For the LCD types

Using [Message]:

1. Push [Message] to display the “Message” screen.

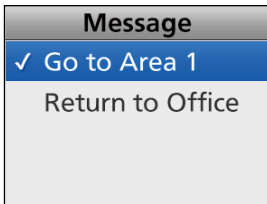

2. Push [Up] or [Down] to select a Message, then push [PTT] to transmit it.
 - ① “Success” is displayed after receiving an acknowledgement from the target station.
 - ① “Failed” is displayed if the target station does not send back an acknowledgement.

Portable: For All types

Mobile: For All types

Using [Message]:

Hold down [Message] for 1 second transmit the preset Message.

TIP: This operation is enabled only when [Selector]’s operation is set to “Message” using the programming software.

Transmitting a call

◇ **Directly entering message**

You can directly enter a message, then send it to the target station or group.

<Menu operation>

Portable: For the Ten-key and the Simple key types

Mobile: For the LCD types

(Menu > Signaling/Call > **Write Message**)

1. Push [Menu] to display the Menu screen.
2. Push [Left] or [Right] to select “Signaling/Call,” then push [OK].



3. Push [Up] or [Down] to select “Write Message,” then push [OK].

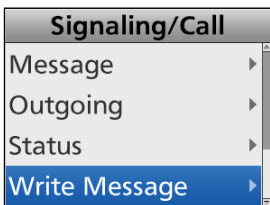

• The “Write Message” screen is displayed.

4. Enter a message of up to 100 characters.

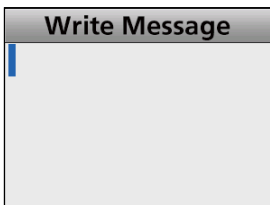

Key	Characters
[0]	. ! ? ' \ , 0
[1]	(space) / + - = \ 1
[2]	a b c A B C 2
[3]	d e f D E F 3
[4]	g h i G H I 4
[5]	j k l J K L 5
[6]	m n o M N O 6
[7]	p q r s P Q R S 7
[8]	t u v T U V 8
[9]	w x y z W X Y Z 9

5. After entering, push [OK].

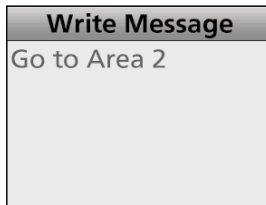
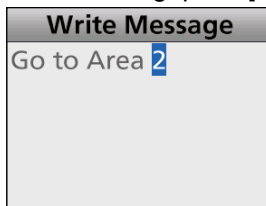

6. Push [PTT] to send it.
 - ① “Success” is displayed after receiving an acknowledgement from the target station.
 - ② “Failed” is displayed if the target station does not send back an acknowledgement.

① **Information**

- To enter the character, push [Up] or [Down].
Usable characters: a ~ z, A ~ Z, 0 ~ 9, / + - = \ . ! ? ' , * # "
- To move the cursor, push [Right] or [Left].
- To insert a space, push [P1].
- To delete, push [P2].
- When using the Portable Ten-key types or Mobile’s optional HM-218, HM-220T, or HM-221T, the Ten-Key pad can be used. See the list to the right above.

TIP:

- The entered message can be temporary saved. After pushing [OK] in step 5, push [Back] to display “Save Message?.” Push [Left] or [Right] to select “Yes,” then push [OK] to save. However, once the transceiver is turned OFF, the saved message is erased.

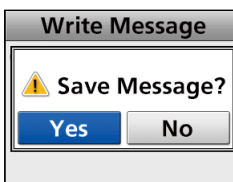

- You can display the “Write Message” screen by pushing [Write Message].

Transmitting a call

◇ **Transmitting a Call Alert call**

A Call Alert call enables you to notify another user who may be away from the transceiver that you want to talk.

<Menu operation>

Portable: For the Ten-key and the Simple key types

Mobile: For the LCD types

<Key operation>

Portable: For all types

Mobile: For all types

(Menu > Signaling/Call > **Call Menu**)

1. Push [Menu] to display the Menu screen.
2. Push [Left] or [Right] to select "Signaling/Call," then push [OK].

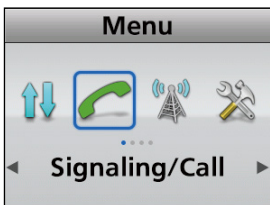

3. Push [Up] or [Down] to select "Call Menu," then push [OK].

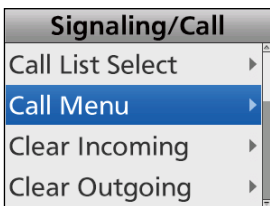

4. Push [Up] or [Down] to select the Individual or Group ID, then push [OK].

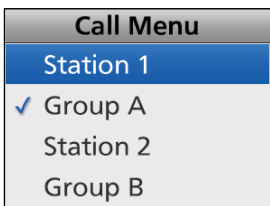

5. Push [Up] or [Down] to select "Call Alert," then push [PTT] to transmit the Call Alert call.

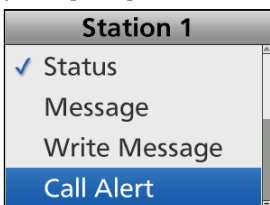

Using [Call Alert]:

Hold down [Call Alert] to transmit the Call Alert call.

- ① "Success" is displayed after receiving an acknowledgement from the target station.
- ① "Failed" is displayed if the target station does not send back an acknowledgement.

- ① "Success" is displayed after receiving an acknowledgement from the target station.
- ① "Failed" is displayed if the target station does not send back an acknowledgement.

Transmitting a call

◇ **Transmitting a Remote Monitor call**

Remote Monitor call enables you to send a signal that requires the target station to transmit the microphone audio.

<Menu operation>

Portable: For the Ten-key and the Simple key types

Mobile: For the LCD types

(Menu > Signaling/Call > **Call Menu**)

1. Push [Menu] to display the Menu screen.
2. Push [Left] or [Right] to select “Signaling/Call,” then push [OK].



3. Push [Up] or [Down] to select “Call Menu,” then push [OK].

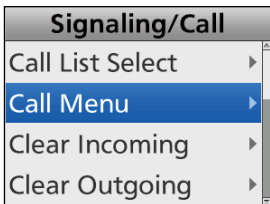

4. Push [Up] or [Down] to select the Individual ID, then push [OK].

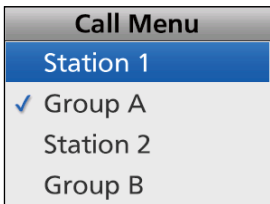

5. Push [Up] or [Down] to select “Remote Monitor,” then push [PTT] to transmit the Remote Monitor call.

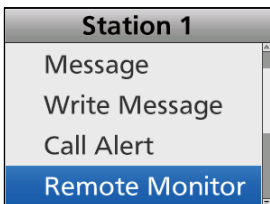

- ① “Success” is displayed after receiving an acknowledgement from the target station.
- ① “Failed” is displayed if the target station does not send back an acknowledgement.
6. The microphone audio can be heard for the preset period of time.

◇ **Transmitting a Radio Check**

Radio Check call enables you to determine whether the target station is turned ON, within the communication range and on the channel, without requiring any action from the target station user.

<Menu operation>

Portable: For the Ten-key and the Simple key types

Mobile: For the LCD types

(Menu > Signaling/Call > **Call Menu**)

1. Push [Menu] to display the Menu screen.
2. Push [Left] or [Right] to select “Signaling/Call,” then push [OK].

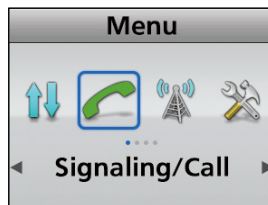

3. Push [Up] or [Down] to select “Call Menu,” then push [OK].

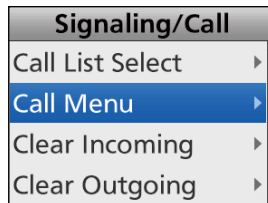

4. Push [Up] or [Down] to select the Individual ID, then push [OK].

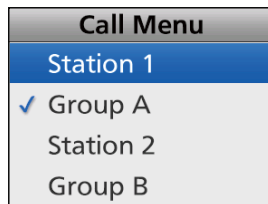

5. Push [Up] or [Down] to select “Radio Check,” then push [PTT] to transmit the Radio Check.

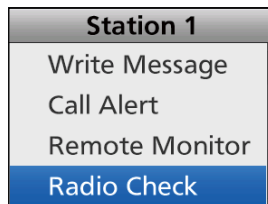

- ① “Success” is displayed after receiving an acknowledgement from the target station.
- ① “Failed” is displayed if the target station does not send back an acknowledgement.

Transmitting a call

◇ **Transmitting a Stun command**

A Stun command enables you to send a signal that will stun the target station.

<Menu operation>

Portable: For the Ten-key and the Simple key types

Mobile: For the LCD types

(Menu > Signaling/Call > **Call Menu**)

1. Push [Menu] to display the Menu screen.
2. Push [Left] or [Right] to select "Signaling/Call," then push [OK].

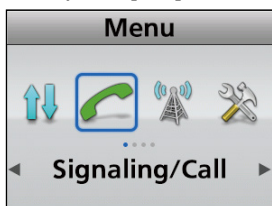

3. Push [Up] or [Down] to select "Call Menu," then push [OK].

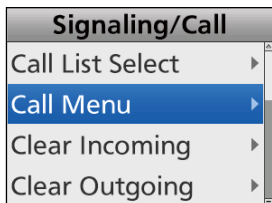

4. Push [Up] or [Down] to select the Individual ID, then push [OK].

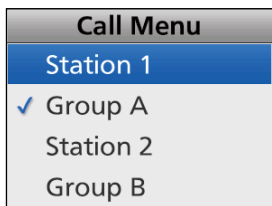

5. Push [Up] or [Down] to select "Stun," then push [PTT] to transmit the Stun command.

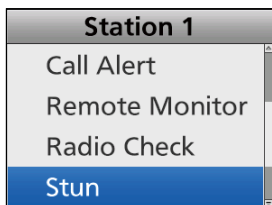

- The target station is stunned.
- ① "Success" is displayed after receiving an acknowledgement from the target station.
- ① "Failed" is displayed if the target station does not send back an acknowledgement.

◇ **Transmitting a Revive command**

A Revive command enables you to send a signal that will revive a stunned station.

<Menu operation>

Portable: For the Ten-key and the Simple key types

Mobile: For the LCD types

(Menu > Signaling/Call > **Call Menu**)

1. Push [Menu] to display the Menu screen.
2. Push [Left] or [Right] to select "Signaling/Call," then push [OK].

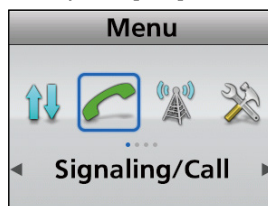

3. Push [Up] or [Down] to select "Call Menu," then push [OK].

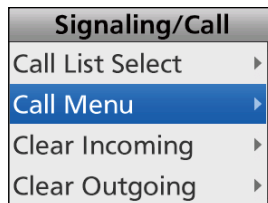

4. Push [Up] or [Down] to select the Individual ID, then push [OK].

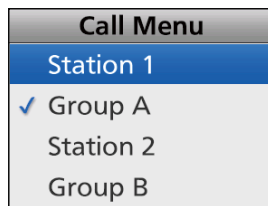

5. Push [Up] or [Down] to select "Revive," then push [PTT] to transmit the Revive command.

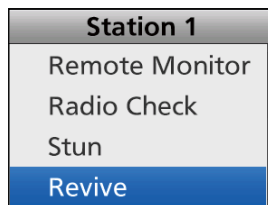

- The stunned station is revived.
- ① "Success" is displayed after receiving an acknowledgement from the target station.
- ① "Failed" is displayed if the target station does not send back an acknowledgement.

Transmitting a call

◇ **Transmitting a Kill command**

A Kill command enables you to send a signal that will disable the target station.

<Menu operation>

Portable: For the Ten-key and the Simple key types

Mobile: For the LCD types

(Menu > Signaling/Call > **Call Menu**)

1. Push [Menu] to display the Menu screen.
2. Push [Left] or [Right] to select "Signaling/Call," then push [OK].

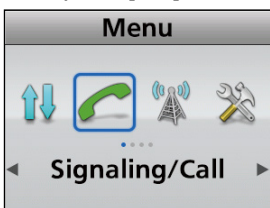

3. Push [Up] or [Down] to select "Call Menu," then push [OK].

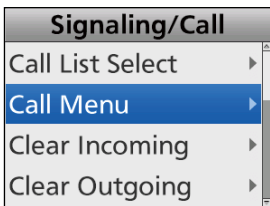

4. Push [Up] or [Down] to select the Individual ID, then push [OK].

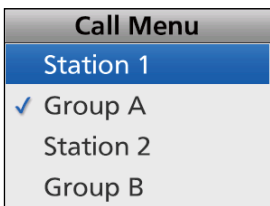

5. Push [Up] or [Down] to select "Kill," then push [PTT] to transmit the Kill command.

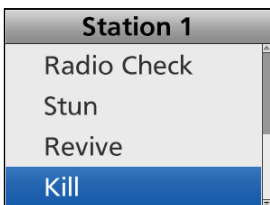

- The target station is disabled.
- ① "Success" is displayed after receiving an acknowledgement from the target station.
- ① "Failed" is displayed if the target station does not send back an acknowledgement.

◇ **Transmitting an Emergency call**

An NXDN Emergency call can be transmitted in the same way as the 2-Tone, 5-Tone, or MDC 1200 signaling operation. See "Emergency call" for details. (pp. 4-3 ~ 4-6)

Transmitting a call

◇ Transmitting Position data

When the GPS function is ON, and the internal GPS receiver receives Position data, the longitude and latitude data can be automatically transmitted:

- When a GPS request status message is received
- After sending a voice message
 - ① Set the 'Send with Login' and 'Send with Logoff' items to 'Enable.'
- After sending a status message
 - ① Set the 'Send with Status Call' item to 'Enable.'
- After sending a message
 - ① Set the 'Send with Message Call' item to 'Enable.'
- After sending a Call Alert
 - ① Set the 'Send with Call Alert' item to 'Enable.'
- After sending an Emergency call
 - ① Set the 'Send with Emergency' item to 'Enable.'
- At the preset interval
 - ① Set the 'Auto' item to 'Enable.'
 - ① Set the 'Interval Timer [mm:ss]' item.

Receiving a call

◇ Receiving an Individual call

- When an Individual call is received:
 - Mute is released.
 - The Status indicator lights green.
 - The calling station name (or ID) is displayed while receiving the signal.*

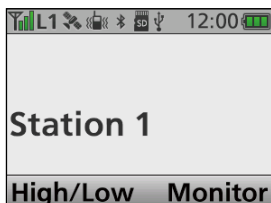

- Hold down [PTT], then speak into the microphone.
- Release [PTT] to receive.

◇ Receiving a Group call

- When a Group call is received:
 - Mute is released.
 - The Status indicator lights green.
 - The Group name and the calling station name (or ID) are displayed while receiving the signal.*
- ① When an All Call is received, "All Call" is displayed.* In that case, you cannot reply to it.

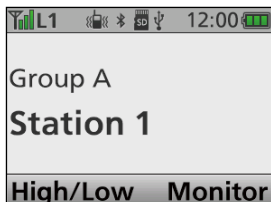

- Hold down [PTT], then speak into the microphone.
- Release [PTT] to receive.

◇ Receiving a Status message

- When a Status message is received:
 - Beeps sound.
 - The Status message and the calling station or Group name (or ID) are displayed.*
 - "✉" blinks.*
 - "🔔" may be displayed or blink, depending on the presetting.*
 - Portable type transceivers may vibrate, depending on the presetting.

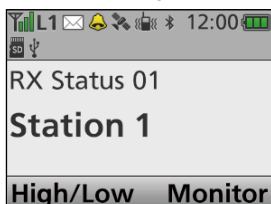

- Push [Back] to stop the display indication.

◇ Receiving a Message

- When a Message is received:
 - Beeps sound.
 - The Message and the calling station or Group name (or ID) are displayed.*
 - "✉" blinks.*
 - "🔔" may be displayed or blink, depending on the presetting.*
 - Portable type transceivers may vibrate, depending on the presetting.

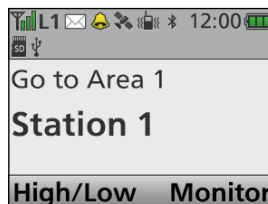

- Push [Back] to stop the display indication.

◇ Receiving a Call Alert call

- When a Call Alert call is received:
 - Beeps sound.
 - "Call Alert" and the calling station or Group name (or ID) are displayed.*
 - "🔔" may be displayed or blink, depending on the presetting.*
 - Portable type transceivers may vibrate, depending on the presetting.

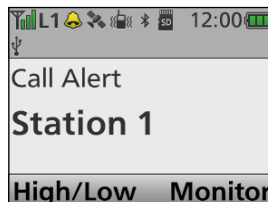

- Hold down [PTT], then speak into the microphone.
- Release [PTT] to receive.

◇ Receiving a Radio Check call

When a Radio check command is received, the transceiver automatically transmits an acknowledgement call. The RAN code matching may not be necessary, depending on the presetting.

◇ Receiving a Remote Monitor call

When a Remote monitor call is received, the microphone audio is automatically transmitted for the set time period. The RAN code matching may not be necessary, depending on the presetting.

*Only for the Portable Ten-key and Simple key types and the Mobile LCD types.

Receiving a call

◇ Receiving a Stun, Kill or Revive

If a Stun or Kill command is received, the transceiver will display “SORRY”^{*1} and you cannot receive or transmit^{*2}.

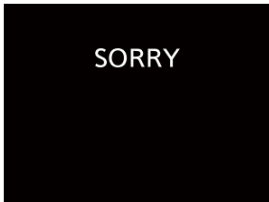

When a Stun command is received, you cannot operate the transceiver until a Revive command is received or the password is input.

When a Kill command is received, you cannot operate the transceiver until data programming is performed.

NOTE: Depending on the presetting, the transceiver can ignore the Stun, Revive and Kill commands that are from a non-specified station.

*1 Only for the Portable Ten-key and Simple key types and the Mobile LCD types.

*2 Depending on the presetting, reception may be enabled.

◇ Receiving an Emergency call

1. When an Emergency call is received:
 - Beeps sound.
 - “RX Emergency” and the calling station name (or ID) are displayed.^{*1}
 - “✉” blinks.^{*1}

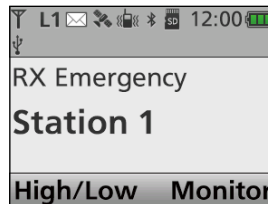

2. When the Send Ack function is turned ON, the transceiver automatically transmits an acknowledgement to the calling station, if the received call type is a Group or All call.
 - ① If the received call type is Individual, and it requests an acknowledgment be sent back, the transceiver automatically sends the acknowledgement.
3. Hold down [PTT], then speak into the microphone.
4. Turn OFF the transceiver, change the channel, or push [PTT] or a key to stop the beep and display indication.

Roaming function (For the Multi-site Trunking operation)

The Multi-site Trunking mode enables the transceiver to move to another site, according to the preset Site list*¹, in order to find a site that has a higher quality signal, or provides better services.

The Roaming function is automatically activated when the transceiver goes out of the range, and does not receive the downlink signal from the repeater in the currently registered site.

In this case, the transceiver displays "Searching."*²

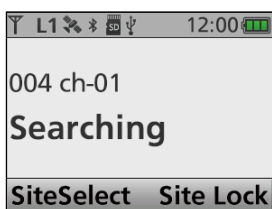

Depending on the presettings, the transceiver tries to register to the repeater that has the strongest RSSI level in the last registered site or an adjacent site. This roaming type takes more time than other roaming types.

The transceiver displays "Out of Range" when the transceiver cannot register to any site after searching.*²

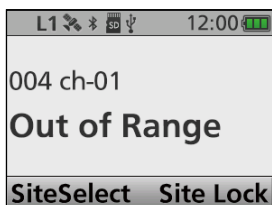

*¹ The valid roaming areas (up to 48) are listed on the Site list.

*² Only for the Portable Ten-key and Simple key types and the Mobile LCD types.

◇ Roaming Request function

The Roaming Request function enables the transceiver to start or resume a Roaming scan, regardless of the error rate.

Push [Roaming Request] to start or resume the Roaming scan.

- ① Even if the Site Lock function is ON, and the transceiver is locked to the currently registered site, pushing [Roaming Request] resumes a Roaming scan.

Site Lock function (For the Multi-site Trunking operation)

You can lock the transceiver to the currently registered site. When this function is ON, the transceiver cancels resuming a Roaming scan, and stays on the current site, regardless of the error rate.

Hold down [Site Lock] for 1 second to turn the Site Lock function ON or OFF.

- “” is displayed when this function is turned ON.

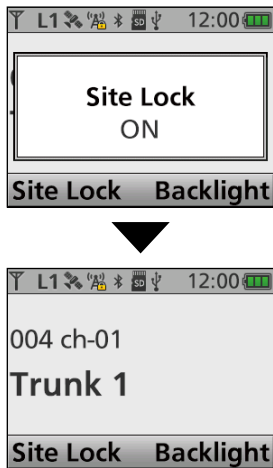

Site Select function (For the Multi-site Trunking operation)

You can manually select a site without a Roaming scan.

1. Push [Site Select] to display the “Site Select” screen.



2. Push [Up] or [Down] to select a site from the preset Site list*.
*Up to 48 valid Roaming areas are listed.
3. Push [OK] to set the selected site, and return to the standby screen.
4. The transceiver tries to register to the selected site.

Displaying the Incoming list

The transceiver saves a log of the received Individual calls, Call Alert calls, Status messages, and Messages in the memory, depending on the presetting.

Up to 10 Message/Status or 5 Voice/Call Alert calls can be saved in the log, and the oldest call record is erased when an 11th (Message/Status) or 6th (Voice/Call Alert) call is received. However, once the transceiver is turned OFF, the all records are erased.

<Menu operation>

Portable: For the Ten-key and the Simple key types

Mobile: For the LCD types

(Menu > Signaling/Call > **Incoming**)

1. Push [Menu] to display the Menu screen.
2. Push [Left] or [Right] to select "Signaling/Call," then push [OK].

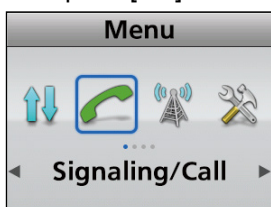

3. Push [Up] or [Down] to select "Incoming," then push [OK].

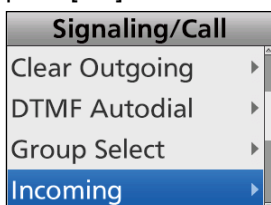

4. Push [Up] or [Down] to select "Voice/Call Alert" or "Message/Status," then push [OK].

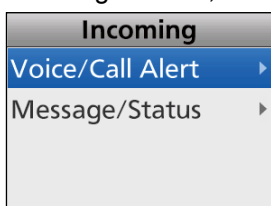

- Voice/Call Alert: The received Individual call and Call Alert call logs are saved.
- Message/Status: The received Status message and Message logs are saved.

5. When "Voice/Call Alert" is selected in step 4, the "Voice/Call Alert" screen is displayed.

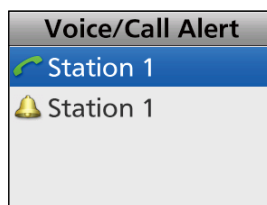

- The calling station name (or ID) is displayed.

① "📞" is for the Individual calls.

② "🔔" is for the Call Alert calls.

TIP: When the "Voice/Call Alert" screen is displayed, skip step 6 and go to step 7.

When "Message/Status" is selected in step 4, the "Message/Status" screen is displayed.

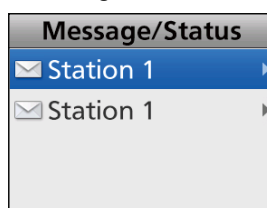

- The calling station name (or ID) is displayed.

① "✉" is for the Status message or Message.

6. Push [Up] or [Down] to select the log, then push [OK].

- The message content is displayed.

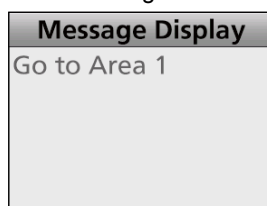

7. Hold down [Back] for 1 second to return to the standby screen.

Displaying the Outgoing list

The transceiver saves a log of the transmitted Individual calls and Call Alert calls in the memory, depending on the presetting.

Up to 5 calls can be saved in the log, and the oldest call record is erased when an 6th call is received.

However, once the transceiver is turned OFF, the all records are erased.

<Menu operation>

Portable: For the Ten-key and the Simple key types

Mobile: For the LCD types

(Menu > Signaling/Call > **Outgoing**)

1. Push [Menu] to display the Menu screen.
2. Push [Left] or [Right] to select "Signaling/Call," then push [OK].

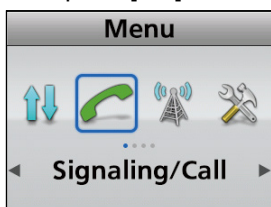

3. Push [Up] or [Down] to select "Outgoing," then push [OK].

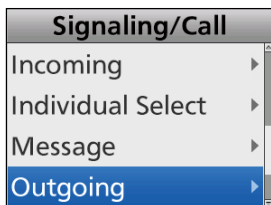

4. The calling station name (or ID) is displayed in the "Outgoing" screen.

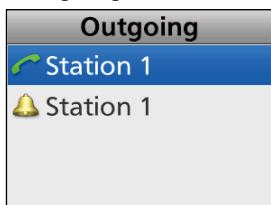

① "📞" is for the Individual calls.

① "🔔" is for the Call Alert calls.

5. Hold down [Back] for 1 second to return to the standby screen.

Deleting the Incoming list

The receive call log can be deleted from the Incoming list.

<Menu operation>

Portable: For the Ten-key and the Simple key types

Mobile: For the LCD types

(Menu > Signaling/Call > **Clear Incoming**)

1. Push [Menu] to display the Menu screen.
2. Push [Left] or [Right] to select "Signaling/Call," then push [OK].

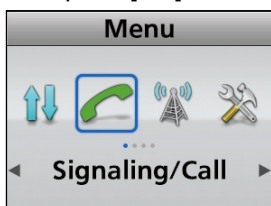

3. Push [Up] or [Down] to select "Clear Incoming," then push [OK].

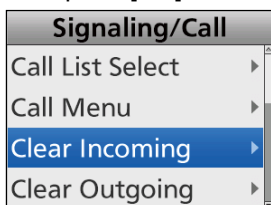

4. Push [Up] or [Down] to select "Voice/Call Alert" or "Message/Status" to be deleted, then push [OK].

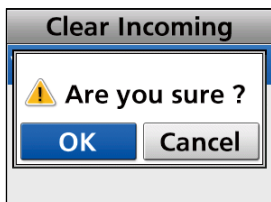
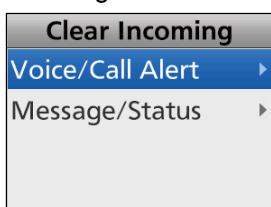

- Voice/Call Alert: The received Individual calls and Call Alert calls are saved in the log.
 - Message/Status: The received Status messages and Messages are saved in the log.
5. Push [Left] or [Right] to select "OK," then push [OK].
 - The selected call log is deleted from the Incoming list.
 6. Hold down [Back] for 1 second to return to the standby screen.

Deleting the Outgoing list

The transmit call log can be deleted from the Outgoing list.

<Menu operation>

Portable: For the Ten-key and the Simple key types

Mobile: For the LCD types

(Menu > Signaling/Call > **Clear Outgoing**)

1. Push [Menu] to display the Menu screen.
2. Push [Left] or [Right] to select "Signaling/Call," then push [OK].

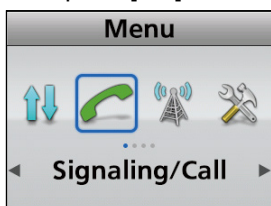

3. Push [Up] or [Down] to select "Clear Outgoing," then push [OK].

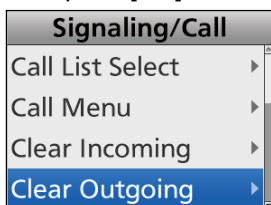

4. Push [Left] or [Right] to select "OK," then push [OK].

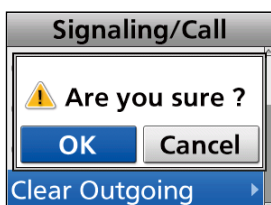

- The selected call log is deleted from the Outgoing list.

5. Hold down [Back] for 1 second to return to the standby screen.

Encryption function

The encryption function enables voice scrambling, which provides private digital communication between stations.

When an encrypted call is received, the squelch will open only when the call contains a matching Key ID*. If a call containing a different Key ID or Cipher Type* is made on the same channel, the squelch will not open, and the user will not hear the call.

* Depending on the presetting, opening the squelch may also require that a matching RAN is included in the call.

Push [Scrambler/Encryption] to toggle the Encryption function ON or OFF.

• “” is displayed when the Encryption function is ON.

① When the Encryption function is ON, push [PTT] to make an encrypted call.

TIP: To use the high level Encryption function, the optional UT-134 AES/DES ENCRYPTION UNIT and the CS-KLD2 KEY LOADER SOFTWARE are required. See the CS-KLD2 Help file or instruction manual for details.

Over The Air Programming function (OTAP)

The Over The Air Programming function (OTAP) enables wireless programming using a transceiver.

Up until now, you needed programming software, a PC, and a data cable to program transceivers. As the number of transceivers in a system increased, the programming cost was higher and it took more time to program.

This function provides easier and faster programming, and lowers the cost.

TIP: See the optional CS-OTPM1 OTAP MANAGER SOFTWARE Help file or its instruction manual for details.

NOTE: When using the OTAP function, the following settings are required in the optional CS-F3400D PROGRAMMING SOFTWARE.

For the OTAP Management transceiver:

When connecting the OTAP Management transceiver to a PC through the Multi-Connector or a D-Sub 25 pin connector:

- Set **Connection Speed** to “19200.”
- Set **Mode** to “PC CMD V2.”
(Common - External I/O - Option - **Multi-Connector/ D-Sub 25pin**)

When connecting the OTAP Management transceiver to a PC through a USB port:

- Set **USB Connection** to “Data Transfer.”
- Set **Serial Mode** to “PC CMD V2.”
(Common - External I/O - Option - **USB Setting**)

For the SU:

Set **OTAP Accept** to “ON.”

(Digital - OTAP - OTAP Setting - **OTAP Accept**)

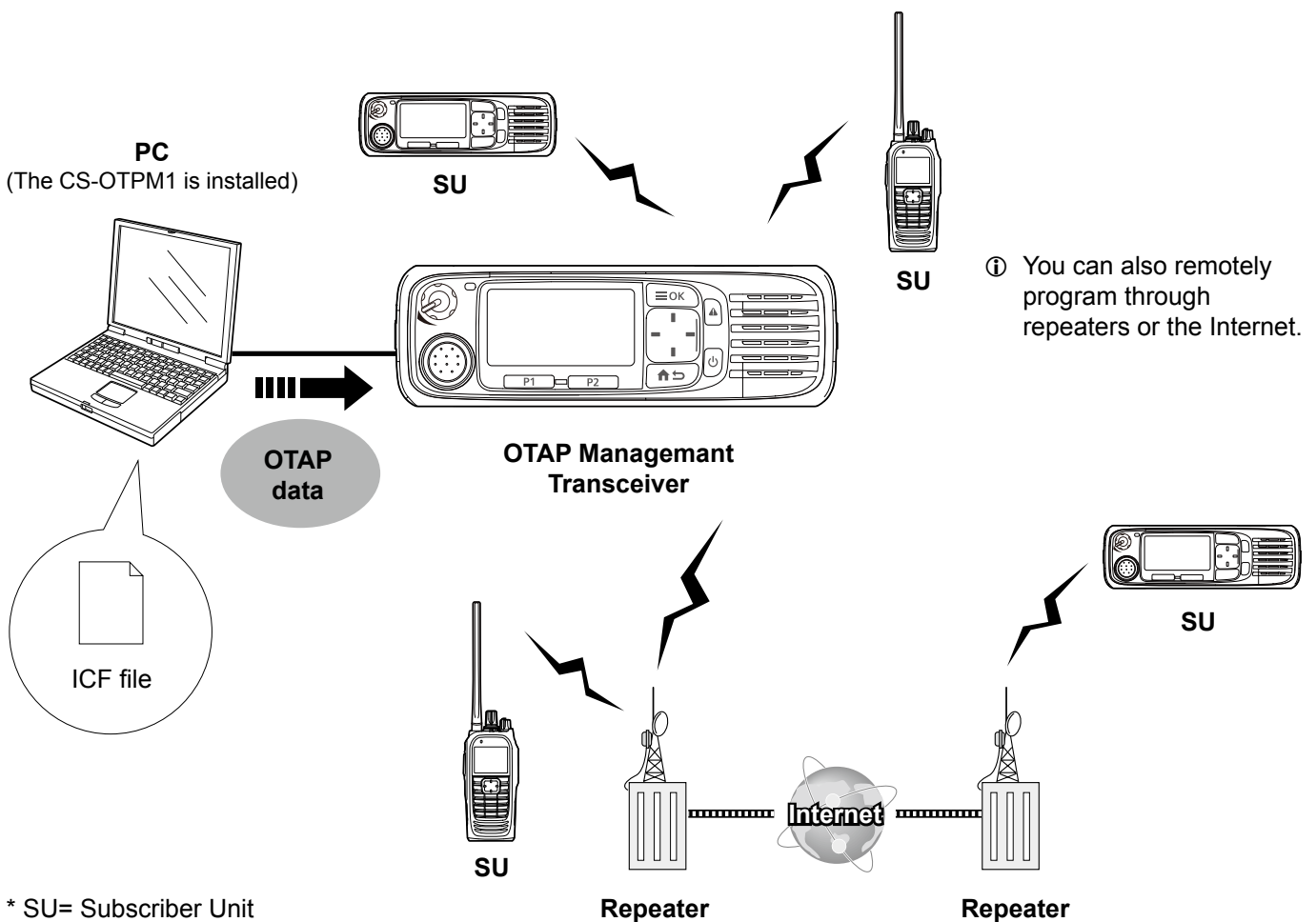

* SU= Subscriber Unit

Section 8

MDC 1200 SYSTEM OPERATION

- MDC 1200 system operation8-2
- Transmitting a call8-3
 - ◇ Transmitting a PTT ID.....8-3
 - ◇ Transmitting an MDC Emergency call8-4
 - ◇ Transmitting an MDC Emergency Acknowledgement.....8-4
 - ◇ Transmitting an MDC Selective Call (Sel Call)8-5
 - ◇ Transmitting an MDC Call Alert call8-6
 - ◇ Transmitting an MDC Radio Check call8-8
 - ◇ Transmitting an MDC Stun call8-10
 - ◇ Transmitting an MDC Revive call.....8-12
 - ◇ Transmitting an MDC Status call8-14
 - ◇ Transmitting an MDC Message call8-16
- Receiving a call8-18
 - ◇ Receiving a PTTID.....8-18
 - ◇ Receiving an MDC Emergency call8-18
 - ◇ Receiving an MDC Selective Call (Sel Call)8-19
 - ◇ Receiving an MDC Call Alert call8-19
 - ◇ Receiving an MDC Stun call or Revive call8-20
 - ◇ Receiving an MDC Status call8-21
 - ◇ Receiving an MDC Message call.....8-21
- Incoming Call log function8-22
 - ◇ Checking the Incoming call log8-22

MDC 1200 system operation

This function is usable in only the Analog mode.

The MDC 1200 signaling system enhances your transceiver's capabilities. You can receive or transmit PTT IDs, Emergency, Selective Call (SelCall), Call Alert, Radio Check, Stun, Revive, Status, and Message calls.

Set one of the assignable software key functions for the MDC 1200 system operations. (pp. 2-13 ~ 2-22)

The display illustration is for the Portable Ten-key type, Portable Simple key type, Mobile LCD type transceivers.

NOTE:

Set the related settings using the CS-F3400D PROGRAMMING SOFTWARE when using the MDC 1200 system. See the Help file for details.

Transmitting a call

◇ Transmitting a PTT ID

You can transmit a call with your station ID.
When another station receives a PTT ID, your station ID is displayed.

Push [PTT] to make a call.

- Beeps sound, depending on the presetting.
- Your station ID is transmitted when you push [PTT] (at the beginning of the transmission) or release [PTT] (at the end of transmission), depending on the presetting.

Transmitting a call

◇ **Transmitting an MDC Emergency call**

An MDC Emergency call can be transmitted in the same way as the 2-Tone, 5-Tone, or NXDN™ signaling operation. See “Emergency call” for details. (pp. 4-3 ~ 4-6)

The transceiver can also be set to keep the microphone open in the Emergency mode to monitor the situation, depending on the presetting.

◇ **Transmitting an MDC Emergency Acknowledgement**

When receiving an MDC Emergency call, an MDC Emergency Acknowledgement is automatically transmitted, depending on the presetting.

Transmitting a call

◇ Transmitting an MDC Selective Call (Sel Call)

An MDC Sel Call enables you to make a call to a specific station, or to a particular group. Other MDC 1200 system transceivers on the channel do not receive a Sel Call that does not include the matching station or group ID.

<Key operation>

1. Push [Call Menu] to display the Call Menu screen.
2. Push [Up] or [Down] to select a station or group ID, then push [OK].

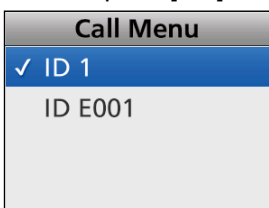

3. Push [Up] or [Down] to select "Sel Call."

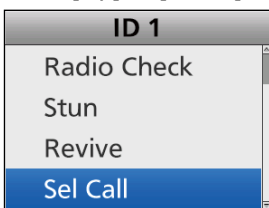

4. Hold down [PTT] to transmit an MDC Sel Call to the selected station.

<Menu operation>

Portable: For the Ten-key and the Simple key types

Mobile: For the LCD type

(Menu > Signaling/Call > Call Menu)

1. Push [Menu] to display the Menu screen.
2. Push [Left] or [Right] to select "Signaling/Call," then push [OK].

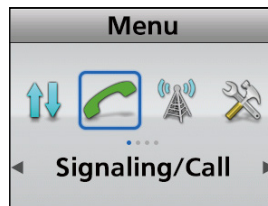

3. Push [Up] or [Down] to select "Call Menu," then push [OK].

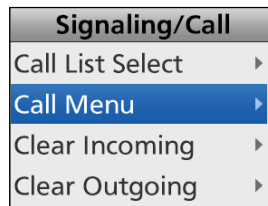

4. Push [Up] or [Down] to select a station or group ID, then push [OK].

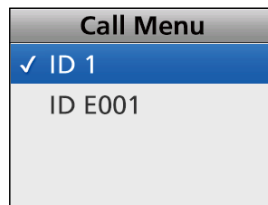

5. Push [Up] or [Down] to select "Sel Call."

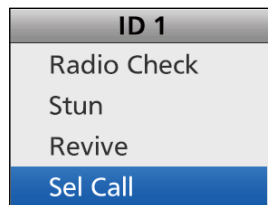

6. Hold down [PTT] to transmit an MDC Sel Call to the selected station.

- "◀" is displayed while transmitting the Sel Call.

Transmitting a call

◇ Transmitting an MDC Call Alert call

An MDC Call Alert call enables you to notify another user who may be away from the transceiver that you want to talk.

It also enables a user who is away from their transceiver, that they have received a call from another user.

<Key operation>

1. Push [Call Menu] to display the Call Menu screen.
2. Push [Up] or [Down] to select a station or group ID, then push [OK].

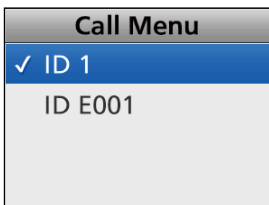

3. Push [Up] or [Down] to select "Call Alert."

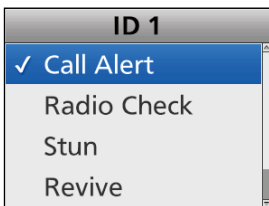

4. Hold down [PTT] to transmit an MDC Call Alert call.

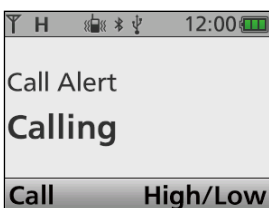

- After receiving an acknowledgement, "Success" is displayed.

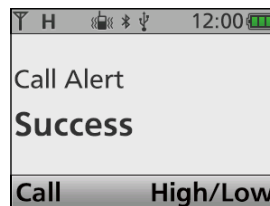

- When the transceiver does not receive an acknowledgement, "Failed" is displayed.

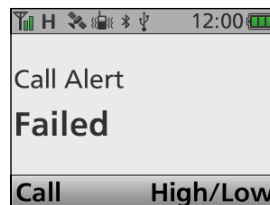

- After transmitting the Call Alert call, returns to the Standby screen.

Transmitting a call

◇ Transmitting an MDC Call Alert call (Continued)

<Menu operation>

Portable: For the Ten-key and the Simple key types

Mobile: For the LCD type

(Menu > Signaling/Call > **Call Menu**)

1. Push [Menu] to display the Menu screen.
2. Push [Left] or [Right] to select "Signaling/Call," then push [OK].

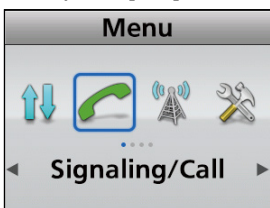

3. Push [Up] or [Down] to select "Call Menu," then push [OK].

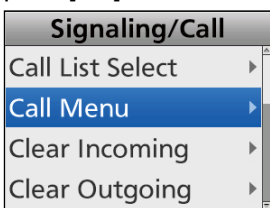

4. Push [Up] or [Down] to select a station or group ID, then push [OK].

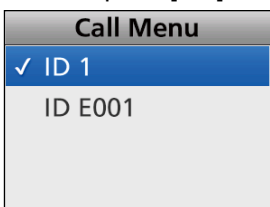

5. Push [Up] or [Down] to select "Call Alert."

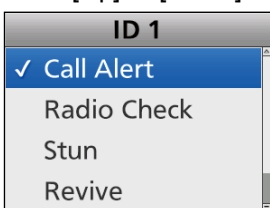

6. Hold down [PTT] to transmit an MDC Call Alert call.

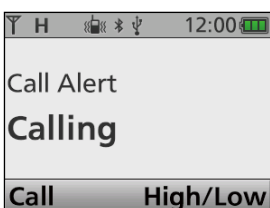

- After receiving an acknowledgement, "Success" is displayed.

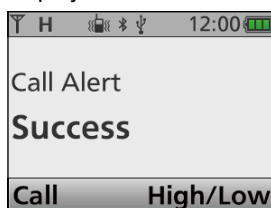

- When the transceiver does not receive an acknowledgement, "Failed" is displayed.

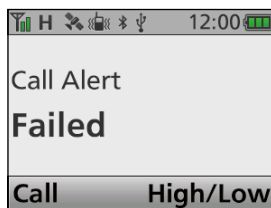

- After transmitting the Call Alert call, returns to the Standby screen.

Transmitting a call

◇ **Transmitting an MDC Radio Check call**

An MDC Radio Check call enables the user to determine whether the targeted station is turned ON, within the communication range and on the channel, without requiring any action from the targeted station user.

<Key operation>

1. Push [Call Menu] to display the Call Menu screen.
2. Push [Up] or [Down] to select a station ID, then push [OK].

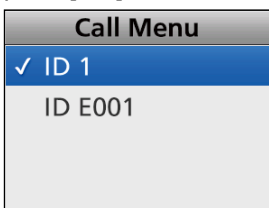

3. Push [Up] or [Down] to select "Radio Check."

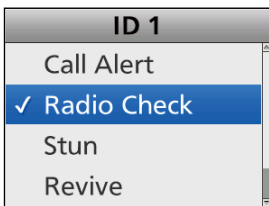

4. Push [PTT] to transmit an MDC Radio Check call.

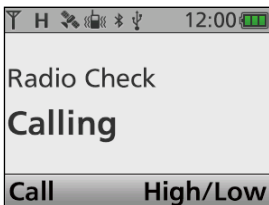

- After receiving an acknowledgement, "Success" is displayed.

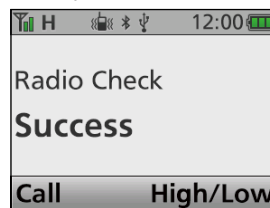

- When the transceiver does not receive an acknowledgement, "Failed" is displayed.

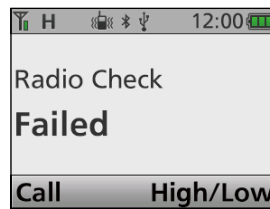

- After transmitting the Radio Check call, returns to the Standby screen.

Transmitting a call

◇ Transmitting an MDC Radio Check call (Continued)

<Menu operation>

Portable: For the Ten-key and the Simple key types

Mobile: For the LCD type

(Menu > Signaling/Call > **Call Menu**)

1. Push [Menu] to display the Menu screen.
2. Push [Left] or [Right] to select "Signaling/Call," then push [OK].

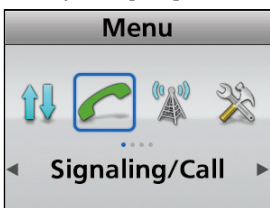

3. Push [Up] or [Down] to select "Call Menu," then push [OK].

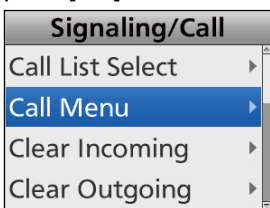

4. Push [Up] or [Down] to select a station ID, then push [OK].

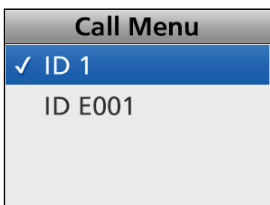

5. Push [Up] or [Down] to select "Radio Check."

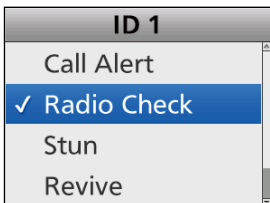

6. Push [PTT] to transmit an MDC Radio Check call.

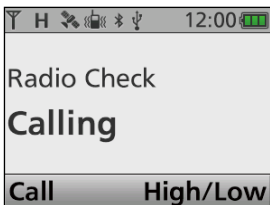

- After receiving an acknowledgement, "Success" is displayed.

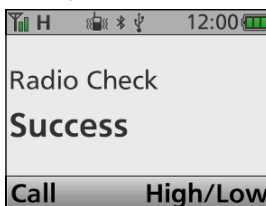

- When the transceiver does not receive an acknowledgement, "Failed" is displayed.

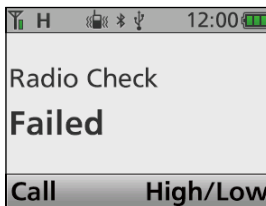

- After transmitting the Radio Check call, returns to the Standby screen.

Transmitting a call

◇ Transmitting an MDC Stun call

An MDC Stun call remotely disables the transceiver.

<Key operation>

1. Push [Call Menu] to display the Call Menu screen.
2. Push [Up] or [Down] to select a station ID, then push [OK].

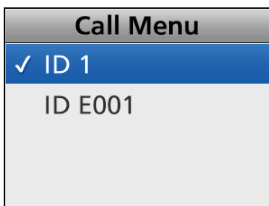

3. Push [Up] or [Down] to select "Stun."

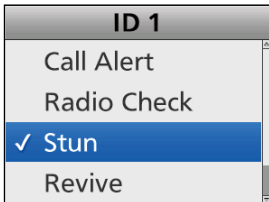

4. Push [PTT] to transmit an MDC Stun call.

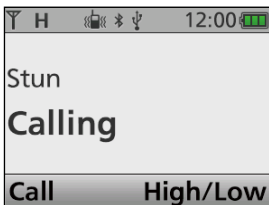

- After receiving an acknowledgement, "Success" is displayed.

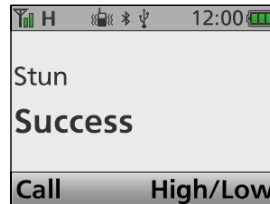

- When the transceiver does not receive an acknowledgement, "Failed" is displayed.

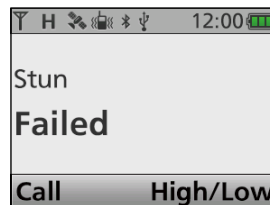

- After transmitting the Stun call, returns to the Standby screen.

Transmitting a call

◇ Transmitting an MDC Stun call (Continued)

<Menu operation>

Portable: For the Ten-key and the Simple key types

Mobile: For the LCD type

(Menu > Signaling/Call > **Call Menu**)

1. Push [Menu] to display the Menu screen.
2. Push [Left] or [Right] to select "Signaling/Call," then push [OK].



3. Push [Up] or [Down] to select "Call Menu," then push [OK].

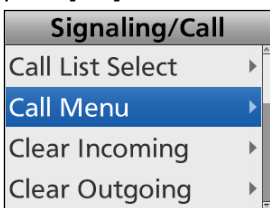

4. Push [Up] or [Down] to select a station ID, then push [OK].

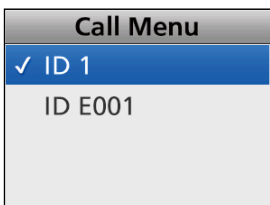

5. Push [Up] or [Down] to select "Stun."

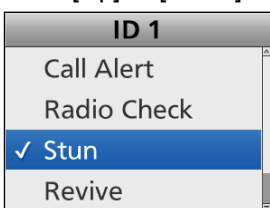

6. Push [PTT] to transmit an MDC Stun call.

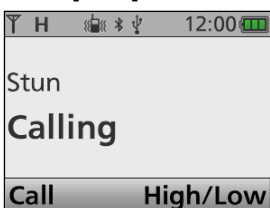

- After receiving an acknowledgement, "Success" is displayed.

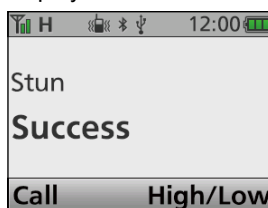

- When the transceiver does not receive an acknowledgement, "Failed" is displayed.

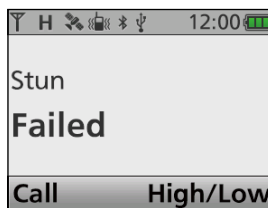

- After transmitting the Stun, returns to the Standby screen.

Transmitting a call

◇ Transmitting an MDC Revive call

An MDC Revive call revives a stunned transceiver to normal operation.

<Key operation>

1. Push [Call Menu] to display the Call Menu screen.
2. Push [Up] or [Down] to select a station ID, then push [OK].

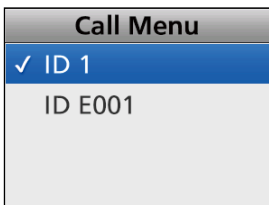

3. Push [Up] or [Down] to select "Revive."

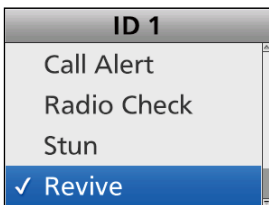

4. Push [PTT] to transmit an MDC Revive call.

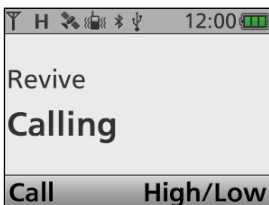

- After receiving an acknowledgement, "Success" is displayed.

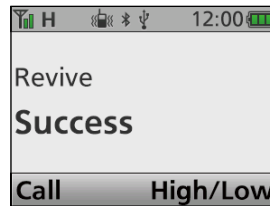

- When the transceiver does not receive an acknowledgement, "Failed" is displayed.

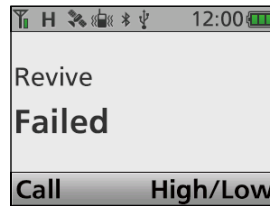

- After transmitting the Revive call, returns to the Standby screen.

Transmitting a call

◇ Transmitting an MDC Revive call (Continued)

<Menu operation>

Portable: For the Ten-key and the Simple key types

Mobile: For the LCD type

(Menu > Signaling/Call > **Call Menu**)

1. Push [Menu] to display the Menu screen.
2. Push [Left] or [Right] to select "Signaling/Call," then push [OK].



3. Push [Up] or [Down] to select "Call Menu," then push [OK].

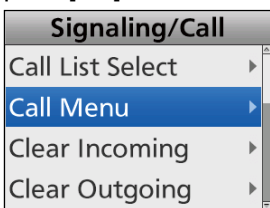

4. Push [Up] or [Down] to select a station ID, then push [OK].

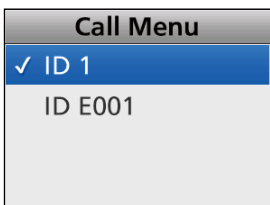

5. Push [Up] or [Down] to select "Revive."

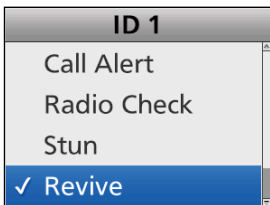

6. Push [PTT] to transmit an MDC Revive call.

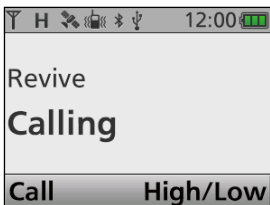

- After receiving an acknowledgement, "Success" is displayed.

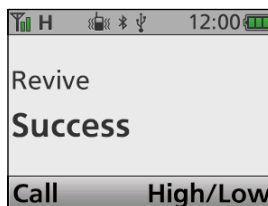

- When the transceiver does not receive an acknowledgement, "Failed" is displayed.

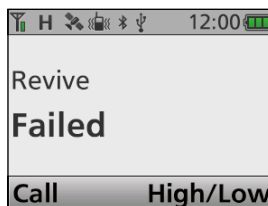

- After transmitting the Revive call, returns to the Standby screen.

Transmitting a call

◇ Transmitting an MDC Status call

An MDC Status call enables you to send a preset Status message. There are 16 kinds of Status messages.

In addition, the transceiver can send an MDC Status Poll call that make the targeted station to automatically transmit a Status call, depending on the presetting.

<Key operation>

- 1. Push [Status] to display the Status list.
- 2. Push [Up] or [Down] to select a Status.

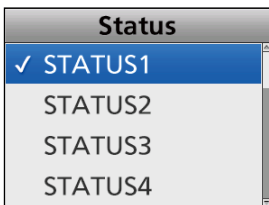

- 3. Hold down [PTT] to transmit an MDC Status call.

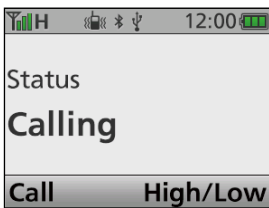

- After receiving an acknowledgement, "Success" is displayed.

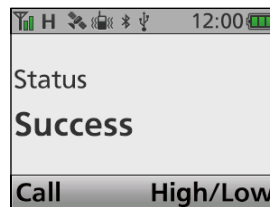

- When the transceiver does not receive an acknowledgement, "Failed" is displayed.

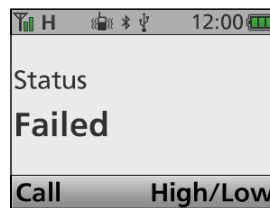

- After transmitting the Status call, returns to the Standby screen.

Transmitting a call

◇ Transmitting an MDC Status call (Continued)

<Menu operation>

Portable: For the Ten-key and the Simple key types

Mobile: For the LCD type

(Menu > Signaling/Call > **Status**)

1. Push [Menu] to display the Menu screen.
2. Push [Left] or [Right] to select "Signaling/Call," then push [OK].

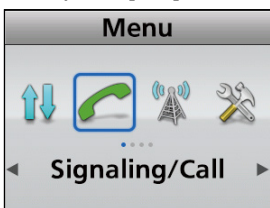

3. Push [Up] or [Down] to select "Status," then push [OK].

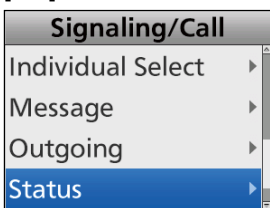

4. Push [Up] or [Down] to select a Status.

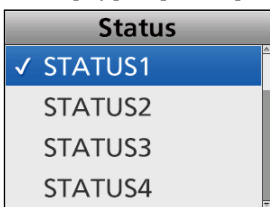

5. Hold down [PTT] to transmit an MDC Status call.

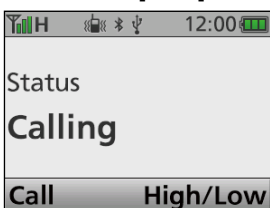

- After receiving an acknowledgement, "Success" is displayed.

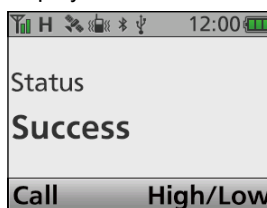

- When the transceiver does not receive an acknowledgement, "Failed" is displayed.

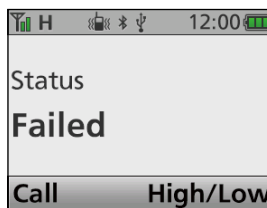

- After transmitting the Status call, returns to the Standby screen.

Transmitting a call

◇ **Transmitting an MDC Message call**

You can send a MDC Message call. There are 16 kinds of Messages.

<Key operation>

1. Push [Message] to display the Message list.
2. Push [Up] or [Down] to select a Message.

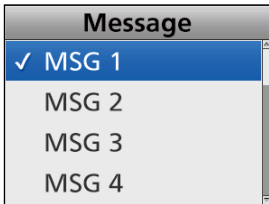

3. Hold down [PTT] to transmit an MDC Message call.

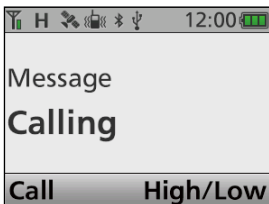

- After receiving an acknowledgement, "Success" is displayed.

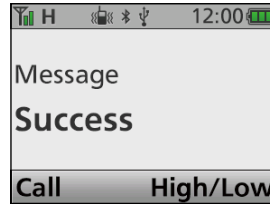

- When the transceiver does not receive an acknowledgement, "Failed" is displayed.

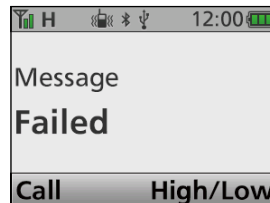

- After transmitting the Message call, returns to the Standby screen.

Transmitting a call

◇ Transmitting an MDC Message call (Continued)

<Menu operation>

Portable: For the Ten-key and the Simple key types

Mobile: For the LCD type

(Menu > Signaling/Call > **Status**)

1. Push [Menu] to display the Menu screen.
2. Push [Left] or [Right] to select "Signaling/Call," then push [OK].

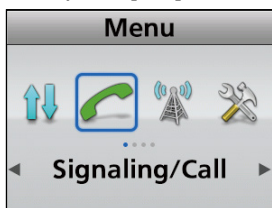

3. Push [Up] or [Down] to select "Message," then push [OK].

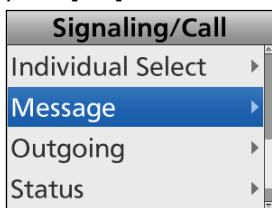

4. Push [Up] or [Down] to select a Message.

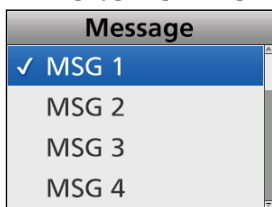

5. Hold down [PTT] to transmit an MDC Message call.

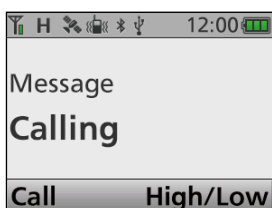

- After receiving an acknowledgement, "Success" is displayed.

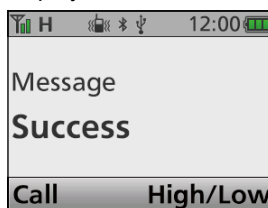

- When the transceiver does not receive an acknowledgement, "Failed" is displayed.

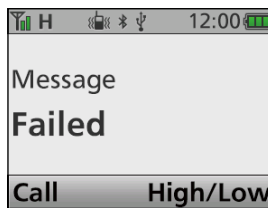

- After transmitting the Message call, returns to the Standby screen.

Receiving a call

◇ Receiving a PTTID

When a PTTID is received.

- Beeps sound, depending on the presetting.
- Portable type transceivers may vibrate, depending on the presetting.
- The calling station's ID is displayed.

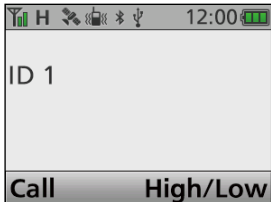

◇ Receiving an MDC Emergency call

When an MDC Emergency call is received:

- Beeps sound.
- Portable type transceivers may vibrate, depending on the presetting.
- The calling station's ID and "Emergency" is displayed.

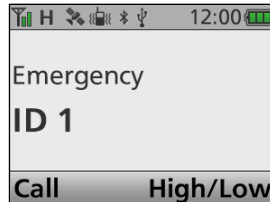

Hold down [PTT] and speak into the microphone.

- ① The transceiver automatically may transmit an acknowledgement to the calling station, depending on the setting.
- ① To stop the Emergency beeps, turn OFF the transceiver, change the channel, or push [PTT] or a key.

Receiving a call

◇ Receiving an MDC Selective Call (Sel Call)

When an MDC Sel Call is received:

- Beeps sound.
- " " is displayed.
- " " blinks.
- The calling station's ID is displayed.

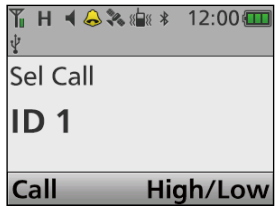

Hold down [PTT] and speak into the microphone.

◇ Receiving an MDC Call Alert call

When an MDC Call Alert call is received,

- Beeps sound.
- " " blinks.
- The calling station's ID is displayed.

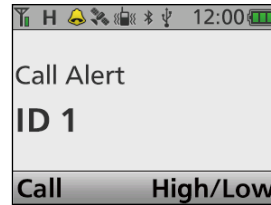

Hold down [PTT] and speak into the microphone.

Receiving a call

◇ **Receiving an MDC Stun call or Revive call**

If an MDC Stun call is received that matches your station ID, the transceiver displays “SORRY” and you can not receive or transmit.



SORRY

To use the transceiver again, you need to:

- receive an MDC Revive call that matches your station ID.
- enter the password.
- setup again using the CS-F3400D.

Receiving a call

◇ Receiving an MDC Status call

When an MDC Status call is received.

- Beeps sound.
- The calling station's ID and the Status are displayed once.

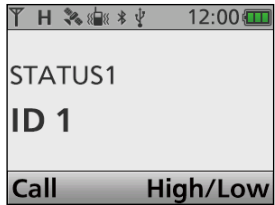

◇ Receiving an MDC Message call

When an MDC Message call is received.

- Beeps sound.
- The calling station's ID and the Message are displayed.

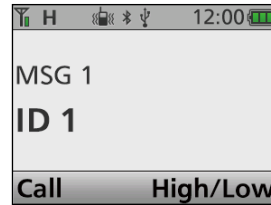

- ① To return to the Standby screen, push [PTT], or change the channel.

Incoming Call log function

After receiving an MDC Sel Call, Call Alert call, or Emergency call, the call log may be displayed, depending on the presetting. Up to 5 calls can be memorized, and the oldest call is deleted when a 6th call is received.

◇ Checking the Incoming call log

(Menu > Signaling/Call > Incoming)

1. Push [Menu] to display the Menu screen.
2. Push [Left] or [Right] to select “Signaling/Call,” then push [OK].



3. Push [Up] or [Down] to select “Incoming,” then push [OK].
① If there is no log, an error beep sounds and the log is not displayed.



- Incoming log is displayed.



BIIS 1200 system operation	9-2
Transmitting a call	9-3
◇ Transmitting an Individual call.....	9-3
◇ Transmitting a Group call.....	9-5
◇ Transmitting a Status message	9-7
◇ Transmitting a Message.....	9-9
◇ Directly entering message	9-11
◇ Transmitting an Emergency call.....	9-12
Receiving a call	9-13
◇ Receiving an Individual call	9-13
◇ Receiving a Group call.....	9-13
◇ Receiving a Status message	9-13
◇ Receiving a Message	9-13
◇ Receiving an Emergency call	9-13
Displaying the Incoming list.....	9-14
Deleting the Incoming list	9-15

BIIS 1200 system operation

This function is usable in only the Analog mode.

The Binary Interchange of Information and Signalling (BIIS) 1200 standard is the best choice to add a data service to an existing system. It enables digital communications, signalling and message exchanges with analog transceivers.

You can receive or transmit Individual calls, Group calls, Emergency calls, Status messages, and Messages.

Set one of the assignable software key functions for the BIIS 1200 system operations. (pp. 2-13 ~ 2-24)

NOTE:

Set the related settings using the CS-F3400D PROGRAMMING SOFTWARE when using the BIIS 1200 system. See the Help file for details.

Transmitting a call

◇ Transmitting an Individual call

<Menu operation>

Portable: For the Ten-key and the Simple key types

Mobile: For the LCD types

(Menu > Signaling/Call > **Call List Select**)

1. Push [Menu] to display the Menu screen.
2. Push [Left] or [Right] to select "Signaling/Call," then push [OK].



3. Push [Up] or [Down] to select "Call List Select," then push [OK].

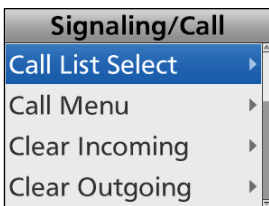

4. Push [Up] or [Down] to select an Individual ID.

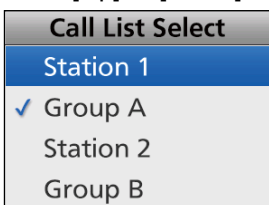

5. Push [PTT] to transmit the Individual call.
 - "Calling" is displayed while transmitting.
 - "Connect" is displayed when an acknowledgement is received.
6. Hold down [PTT] and speak at your normal voice level.
7. Release [PTT] to receive.
8. After the communication is finished, push [Back] to send a Clear down signal to terminate the connection.

Transmitting a call

◇ Transmitting an Individual call (Continued)

<Key operation>

Portable: For the Ten-key and the Simple key types

Mobile: For the LCD types

Using [Call List Select]:

1. Push [Call List Select] to display the “Call List Select” screen.

Call List Select
Station 1
✓ Group A
Station 2
Group B

2. Push [Up] or [Down] to select an Individual ID.

Call List Select
Station 1
✓ Group A
Station 2
Group B

3. Push [PTT] to transmit the Individual call.
 - “Calling” is displayed while transmitting.
 - “Connect” is displayed when an acknowledgement is received.
4. Hold down [PTT] and speak at your normal voice level.
5. Release [PTT] to receive.
6. After the communication is finished, push [Back] to send a Clear down signal to terminate the connection.

Using [Individual]:

1. Push [Individual] to display the “Individual Select” screen.

Individual Select
✓ Station 1
Station 2

2. Push [Up] or [Down] to select an Individual ID.

Individual Select
✓ Station 1
Station 2

3. Push [PTT] to transmit the Individual call.
 - “Calling” is displayed while transmitting.
 - “Connect” is displayed when an acknowledgement is received.
4. Hold down [PTT] and speak at your normal voice level.
5. Release [PTT] to receive.
6. After the communication is finished, push [Back] to send a Clear down signal to terminate the connection.

TIP: You can display the “Individual Select” screen through the Menu screen.
(Menu > Signaling/Call > **Individual Select**)

Transmitting a call

◇ Transmitting a Group call

<Menu operation>

Portable: For the Ten-key and the Simple key types

Mobile: For the LCD types

(Menu > Signaling/Call > **Call List Select**)

1. Push [Menu] to display the Menu screen.
2. Push [Left] or [Right] to select "Signaling/Call," then push [OK].



3. Push [Up] or [Down] to select "Call List Select," then push [OK].

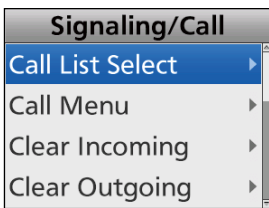

4. Push [Up] or [Down] to select a Group ID.

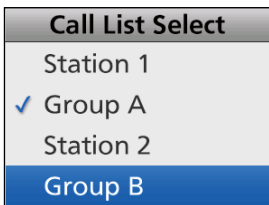

5. Push [PTT] to transmit the Group call.
6. Hold down [PTT] and speak at your normal voice level.
7. Release [PTT] to receive.
8. After the communication is finished, push [Back] to send a Clear down signal to terminate the connection.

Transmitting a call

◇ Transmitting a Group call (Continued)

<Key operation>

Portable: For the Ten-key and the Simple key types

Mobile: For the LCD types

Using [Call List Select]:

1. Push [Call List Select] to display the “Call List Select” screen.

Call List Select
Station 1
✓ Group A
Station 2
Group B

2. Push [Up] or [Down] to select a Group ID.

Call List Select
Station 1
✓ Group A
Station 2
Group B

3. Push [PTT] to transmit the Group call.
4. Hold down [PTT] and speak at your normal voice level.
5. Release [PTT] to receive.
6. After the communication is finished, push [Back] to send a Clear down signal to terminate the connection.

Using [Group]:

1. Push [Group] to display the “Group Select” screen.
2. Push [Up] or [Down] to select a Group ID.

Group Select
✓ Group A
Group B

3. Push [PTT] to transmit the Group call.
4. Hold down [PTT] and speak at your normal voice level.
5. Release [PTT] to receive.
6. After the communication is finished, push [Back] to send a Clear down signal to terminate the connection.

TIP: You can display the “Group Select” screen through the Menu screen.
(Menu > Signaling/Call > **Group Select**)

Transmitting a call

◇ **Transmitting a Status message**

You can transmit a preset Status message. You cannot transmit a voice call at the same time.

NOTE:

- Depending on the presetting, the Priority A channel is always used to send status messages.
- The status message can be automatically transmitted when:
 - The transceiver is turned ON.
 - ① Set the 'Power ON Status23' item to 'Enable.'
 - The transceiver is turned OFF.
 - ① Set the 'Power OFF Status19' item to 'Enable.'

<Menu operation>

Portable: For the Ten-key and the Simple key types

Mobile: For the LCD types

(Menu > Signaling/Call > **Call Menu**)

1. Push [Menu] to display the Menu screen.
2. Push [Left] or [Right] to select "Signaling/Call," then push [OK].



3. Push [Up] or [Down] to select "Call Menu," then push [OK].

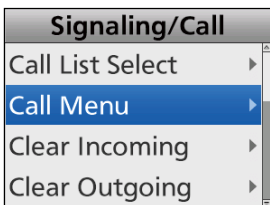

4. Push [Up] or [Down] to select an Individual or Group ID, then push [OK].

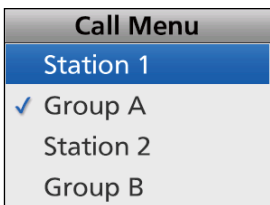

5. Push [Up] or [Down] to select "Status," then push [OK].

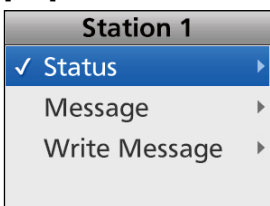

6. Push [Up] or [Down] to select a Status Message, then push [PTT] to transmit a Status call.

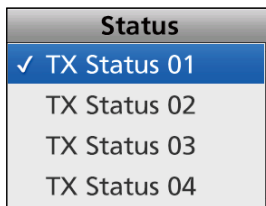

- ① "Success" is displayed after receiving an acknowledgement from the target station.
- ① "Failed" is displayed if the target station does not send back an acknowledgement.

(Menu > Signaling/Call > **Status**)

1. Push [Menu] to display the Menu screen.
2. Push [Left] or [Right] to select "Signaling/Call," then push [OK].
3. Push [Up] or [Down] to select "Status," then push [OK].

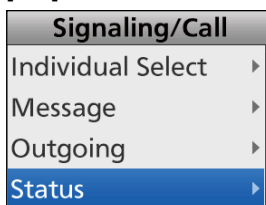

4. Push [Up] or [Down] to select a Status Message, then push [PTT] to transmit a Status call to the currently selected target station.
 - ① "Success" is displayed after receiving an acknowledgement from the target station.
 - ① "Failed" is displayed if the target station does not send back an acknowledgement.

Transmitting a call

◇ Transmitting a Status message (Continued)

<Key operation>

Portable: For the Ten-key and the Simple key types

Mobile: For the LCD types

Using [Status]:

1. Push [Status] to display the “Status” screen.

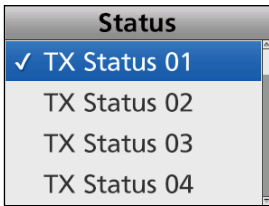

2. Push [Up] or [Down] to select a Status Message, then push [PTT] to transmit it.
 - ① “Success” is displayed after receiving an acknowledgement from the target station.
 - ① “Failed” is displayed if the target station does not send back an acknowledgement.

Portable: For the Non-display types

Mobile: For the Segment types

Using [Status]:

Hold down [Status] for 1 second to transmit the preset Status Message.

TIP: This operation is enabled only when [Selector] is set to “Status” using the programming software.

Transmitting a call

◇ **Transmitting a Message**

You can transmit a message of up to 14 characters.

<Menu operation>

Portable: For the Ten-key and the Simple key types

Mobile: For the LCD types

(Menu > Signaling/Call > **Call Menu**)

1. Push [Menu] to display the Menu screen.
2. Push [Left] or [Right] to select "Signaling/Call," then push [OK].

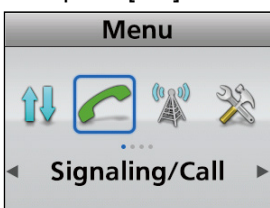

3. Push [Up] or [Down] to select "Call Menu," then push [OK].

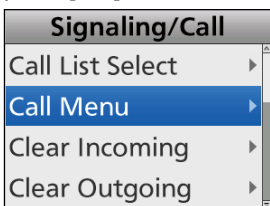

4. Push [Up] or [Down] to select an Individual or Group ID, then push [OK].

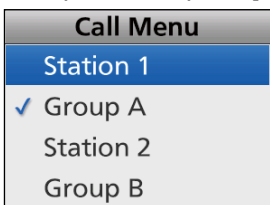

5. Push [Up] or [Down] to select "Message," then push [OK].

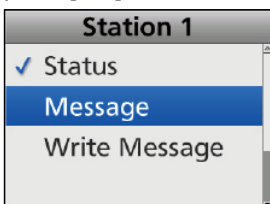

6. Push [Up] or [Down] to select a Message, then push [PTT] to transmit it.

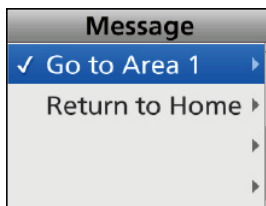

- ① "Success" is displayed after receiving an acknowledgement from the target station.
- ① "Failed" is displayed if the target station does not send back an acknowledgement.

(Menu > Signaling/Call > **Message**)

1. Push [Menu] to display the Menu screen.
2. Push [Left] or [Right] to select "Signaling/Call," then push [OK].
3. Push [Up] or [Down] to select "Message," then push [OK].

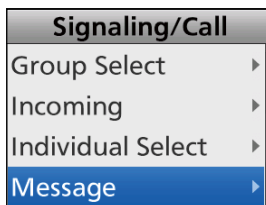

4. Push [Up] or [Down] to select a Message, then push [PTT] to transmit it to the currently selected target station.

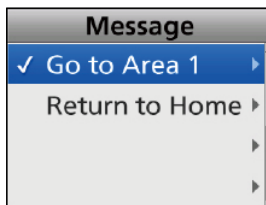

- ① "Success" is displayed after receiving an acknowledgement from the target station.
- ① "Failed" is displayed if the target station does not send back an acknowledgement.

Transmitting a call

<Key operation>

Portable: For the Ten-key and the Simple key types

Mobile: For the LCD types

Using [Message]:

1. Push [Message] to display the "Message" screen.

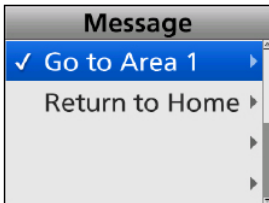

2. Push [Up] or [Down] to select a Message, then push [PTT] to transmit it.
 - ① "Success" is displayed after receiving an acknowledgement from the target station.
 - ① "Failed" is displayed if the target station does not send back an acknowledgement.

Portable: For the Non-display types

Mobile: For the Segment types

Using [Message]:

Hold down [Message] for 1 second to transmit the preset Message.

TIP: This operation is enabled only when [Selector] is set to "Message" using the programming software.

Transmitting a call

◇ **Directly entering message**

You can directly enter a message, then send it to the target station or group.

<Menu operation>

Portable: For the Ten-key and the Simple key types

Mobile: For the LCD types

(Menu > Signaling/Call > **Write Message**)

1. Push [Menu] to display the Menu screen.
2. Push [Left] or [Right] to select "Signaling/Call," then push [OK].

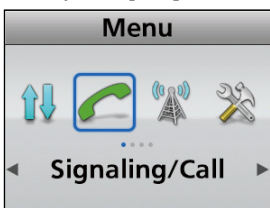

3. Push [Up] or [Down] to select "Write Message," then push [OK].

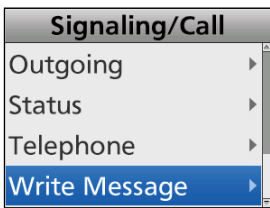

• The "Write Message" screen is displayed.

4. Enter a message of up to 14 characters.

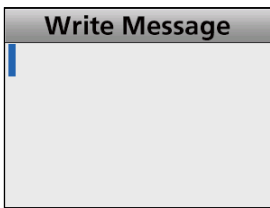

Key	Characters
[0]	. ! ? ' \ , 0
[1]	(space) / + - = \ 1
[2]	a b c A B C 2
[3]	d e f D E F 3
[4]	g h i G H I 4
[5]	j k l J K L 5
[6]	m n o M N O 6
[7]	p q r s P Q R S 7
[8]	t u v T U V 8
[9]	w x y z W X Y Z 9

5. After entering, push [OK].

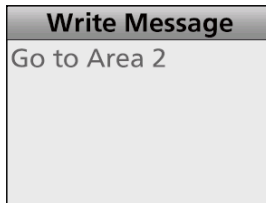
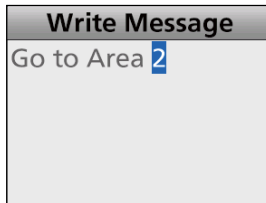

6. Push [PTT] to send it.
 - ① "Success" is displayed after receiving an acknowledgement from the target station.
 - ② "Failed" is displayed if the target station does not send back an acknowledgement.

① **Information**

- To enter a character, push [Up] or [Down].
Usable characters: a ~ z, A ~ Z, 0 ~ 9, / + - = \ . ! ? ' , * # "
- To move the cursor, push [Right] or [Left].
- To insert a space, push [P1].
- To delete, push [P2].
- When using the Portable Ten-key types or Mobile's optional HM-218, HM-220T, or HM-221T, the Ten-Key pad can be used. See the list to the right above.

TIP:

- The entered message can be temporarily saved. After pushing [OK] in step 5, push [Back] to display "Save Message?." Push [Left] or [Right] to select "Yes," then push [OK] to save. However, once the transceiver is turned OFF, the saved message is erased.

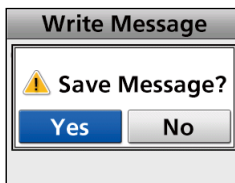

- You can display the "Write Message" screen by pushing [Write Message].

Transmitting a call

◇ **Transmitting an Emergency call**

When a BIIS channel is used as the Emergency channel, a BIIS Emergency call can be transmitted in the same way as the 2-Tone, 5-Tone, or NXDN™ signaling operation.

See “Emergency call” for details. (pp. 4-3 ~ 4-6)

If your transceiver is programmed for Silent operation, you can transmit Emergency calls without the beep sounding or the display changing.

The transceiver can also be set to keep the microphone open in the Emergency mode to monitor the situation, depending on the presetting.

Receiving a call

◇ Receiving an Individual call

- When an Individual call is received:
 - The Status indicator lights green.
 - “🔔” may be displayed or blink, depending on the presetting.*
 - “🔇” is displayed and the mute is released.*
 - Your own name (or ID) and the calling station name (or ID) is displayed while receiving the signal.*

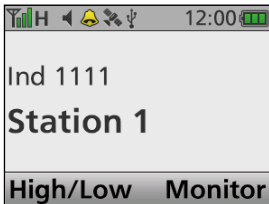

- Hold down [PTT], then speak into the microphone.
 - Release [PTT] to receive.
 - After the communication is finished, push [Back] to send a clear down signal to terminate the connection.
 - “CLR DOWN” is displayed.*
 - “🔇” disappears.*
- ① Either station can send a Clear down signal.

◇ Receiving a Group call

- When a Group call is received:
 - The Status indicator lights green.
 - “🔔” may be displayed or blink, depending on the presetting.*
 - “🔇” is displayed and the mute is released.*
 - The group name (or ID) and the calling station name (or ID) is displayed while receiving the signal.*

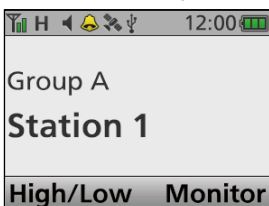

- Hold down [PTT], then speak into the microphone.

NOTE: Only one station is allowed to speak at the same time.
 - Release [PTT] to receive.
 - After the communication is finished, push [Back] to send a clear down signal to terminate the connection.
 - “CLR DOWN” is displayed.*
 - “🔇” disappears.*
- ① Any station can send a Clear down signal.

◇ Receiving a Status message

- When a Status message is received:
 - Beeps sound.
 - The Status message and the calling station or Group name (or ID) are displayed.*
 - “✉️” blinks.*

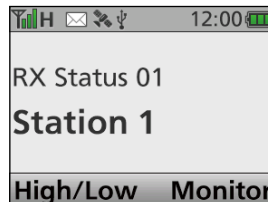

- Push [Back] to stop the display indication.

◇ Receiving a Message

- When a Message is received:
 - Beeps sound.
 - The Message and the calling station or Group name (or ID) are displayed.*
 - “✉️” blinks.*

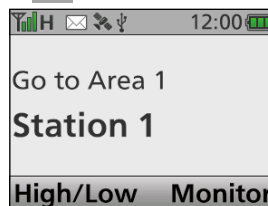

- Push [Back] to stop the display indication.

◇ Receiving an Emergency call

- When an Emergency call is received:
 - Beeps sound.
 - The Emergency text and the calling station name (or ID) are displayed.*¹
 - “✉️” blinks.*¹

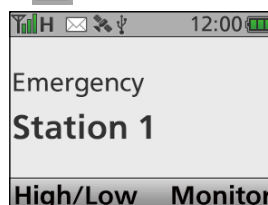

- Hold down [PTT], then speak into the microphone.
- To stop the beep and display indication, turn OFF the transceiver, change the channel, or push [PTT] or a key.

Displaying the Incoming list

The transceiver saves a log of the received Individual calls, Group calls, Status messages, Messages, and Emergency calls in the memory.

Up to 10 Message/Status/Emergency or 5 Voice calls can be saved in the log, and the oldest call record is erased when an 11th (Message/Status/Emergency) or 6th (Voice) call is received. However, once the transceiver is turned OFF, all of the records are erased.

<Menu operation>

Portable: For the Ten-key and the Simple key types

Mobile: For the LCD types

(Menu > Signaling/Call > **Incoming**)

1. Push [Menu] to display the Menu screen.
2. Push [Left] or [Right] to select "Signaling/Call," then push [OK].



3. Push [Up] or [Down] to select "Incoming," then push [OK].



4. Push [Up] or [Down] to select "Voice" or "Message/Status," then push [OK].

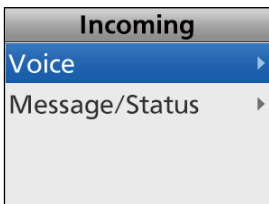

- Voice: The received Individual call and Group call logs are saved.
- Message/Status: The received Status message and Message logs are saved.

5. When "Voice" is selected in step 4, the "Voice" screen is displayed.

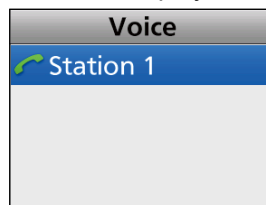

- The calling station name (or ID) is displayed.

TIP: When the "Voice" screen is displayed, skip step 6 and go to step 7.

When "Message/Status" is selected in step 4, the "Message/Status" screen is displayed.

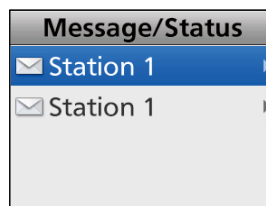

- The calling station name (or ID) is displayed.

6. Push [Up] or [Down] to select the log, then push [OK].

- The message content is displayed.

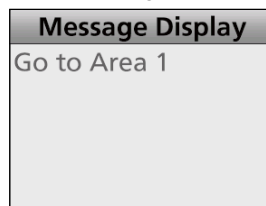

7. Hold down [Back] for 1 second to return to the standby screen.

Deleting the Incoming list

The receive call log can be deleted from the Incoming list.

<Menu operation>

Portable: For the Ten-key and the Simple key types

Mobile: For the LCD types

(Menu > Signaling/Call > **Clear Incoming**)

1. Push [Menu] to display the Menu screen.
2. Push [Left] or [Right] to select "Signaling/Call," then push [OK].

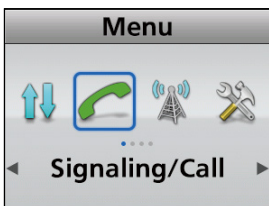

3. Push [Up] or [Down] to select "Clear Incoming," then push [OK].

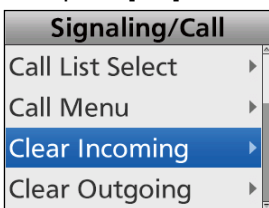

4. Push [Up] or [Down] to select "Voice" or "Message/Status" to be deleted, then push [OK].

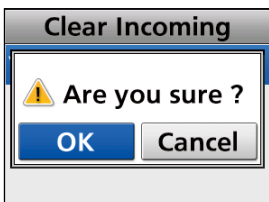
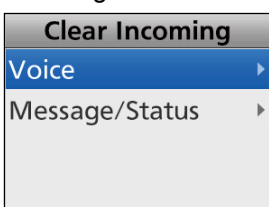

- Voice: The received Individual calls and Group calls are deleted from the log.
 - Message/Status: The received Status messages and Messages are deleted from the log.
5. Push [Left] or [Right] to select "OK," then push [OK].
 - The selected call log is deleted from the Incoming list.
 6. Hold down [Back] for 1 second to return to the standby screen.

Section 10 ABOUT THE microSD CARD

About the microSD card	10-2
Saving data onto the microSD card.....	10-2
Inserting or removing the microSD card	10-3
◇ Inserting	10-3
◇ Removing.....	10-3
Unmounting the microSD card	10-4
Formatting the microSD card.....	10-4
Loading the saved data files onto a microSD card	10-5
Displaying the information of the microSD card	10-6
Backing up the data saved on the microSD card onto a PC	10-7
◇ About the microSD card's folder contents.....	10-7
◇ Making a backup file on your PC	10-8

About the microSD card

The microSD or microSDHC card is not supplied by Icom. User supplied.

Users can use a microSDHC of up to 32 GB. Icom has checked the compatibility with the following microSDHC cards.

(As of March 2017)

Brand	Type	Memory size
SanDisk®	microSDHC	4 GB
		8 GB
		16 GB
		32 GB

- ① The above list does not guarantee the card's performance.
- ① Through the rest of this document, the microSDHC card is simply called the microSD card or the card.

TIP: Icom recommends that a user save the transceiver's factory default data for backup. (p. 10-9)

NOTE:

- Before using the microSD card, thoroughly read the card's instructions.
- If you do any of the following, the card data may be corrupted or deleted.
 - You remove the card from the transceiver while the card is being accessed.
 - A power failure occurs, or the power cable (Mobile type) or battery pack (Portable type) is disconnected while the card is being accessed.
 - You drop, impact or vibrate the card.
- Do not touch the contacts of the card.
- The transceiver takes a longer time to recognize a high capacity card.
- The card will get warm if continuously used for a long period of time.
- The card has a certain lifetime, so data reading or writing may not be possible after using it for a long period of time.

When reading or writing data is impossible, the card's lifetime has ended. In that case, use a new one.

We recommend you make a separate backup file of the important data onto your PC. (p. 10-9)
- Icom will not be responsible for any damage caused by data corruption on a card.

Saving data onto the microSD card

A user can save the following data onto the microSD card:

- Communication audio
 - The transmitted and received audio.
- Data settings of the transceiver
 - Memory channel contents saved in the optional programming software.
- Firmware files
 - The firmware files to update the transceiver's firmware.
- Voice audio of an Emergency

Inserting or removing the microSD card

NOTE: Use the transceiver's built-in Format function to format all microSD cards to be used with the transceiver. Format, even preformatted cards for PCs or other uses. (p. 10-4)

◇ Inserting

● Portable types

Insert the card into the slot until it locks in place, until it makes a 'click' sound.

- The SD card icon is displayed when the microSD card is inserted.

① Be sure to check the card orientation.

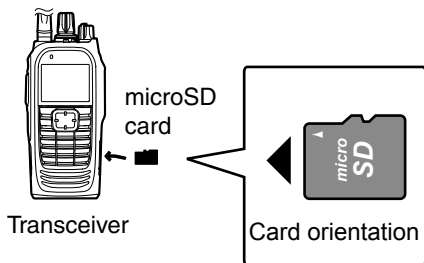

● Mobile types

1. Turn OFF the transceiver.
2. Turn the transceiver upside down.
3. Push the locking tab using a solid tool, such as a flat-bladed screwdriver (①), then detach the front panel (②).

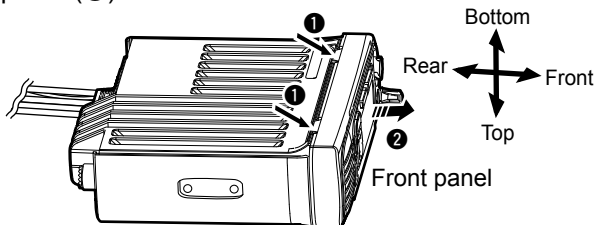

4. Turn the transceiver right-side up.
5. Insert the card into the slot until it locks in place, and makes a 'click' sound.
 - The SD card icon is displayed when the microSD card is inserted.

① Be sure to check the card orientation.

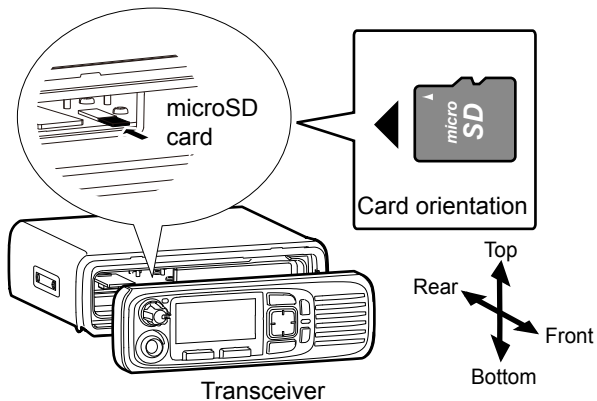

6. Attach the front panel, then turn ON the transceiver.

◇ Removing

● Portable types

Push in the microSD card until a click sounds.

- The card is unlocked, and you can pull it out.

① Before you remove the microSD card while the transceiver's power is ON, be sure to first unmount it. (p. 10-4)

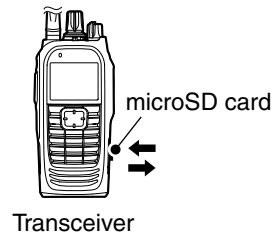

● Mobile types

1. Detach the front panel, as described to the left.
2. Push in the microSD card until it makes a click sound.

- The card is unlocked, and you can pull it out.

① Before you remove the microSD card while the transceiver's power is ON, be sure to first unmount it. (p. 10-4)

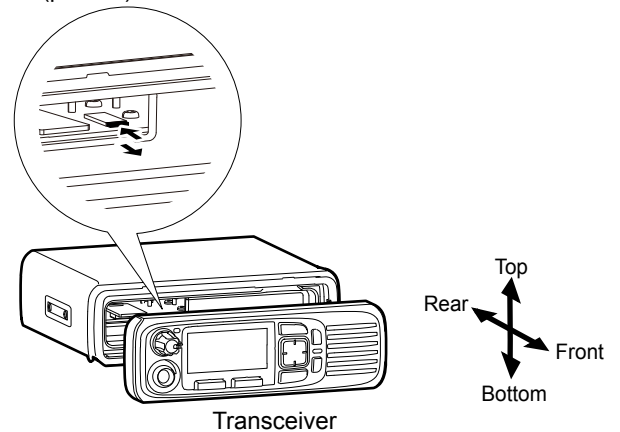

Unmounting the microSD card

Before you remove a card when the transceiver is ON, be sure to first electrically unmount it, as shown below. Otherwise the data may be corrupted or deleted.

TIP: For the Portable Non-Display types and Mobile Segment types

Before removing a card, be sure to turn OFF the transceiver.

<Menu operation>

Portable: For the Ten-key and the Simple key types

Mobile: For the LCD types

(Menu > SD Card > **SD Unmount**)

1. Push [Menu] to display the Menu screen.
2. Push [Left] or [Right] to select "SD Card," then push [OK].

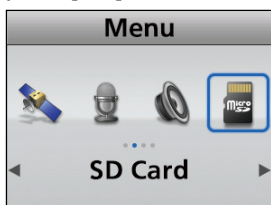

3. Push [Up] or [Down] to select "SD Unmount," then push [OK].
 - "Are you sure?" is displayed.

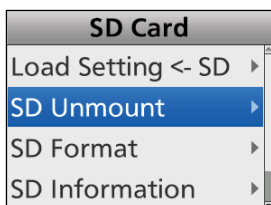

4. Push [Left] or [Right] to select <OK>, then push [OK].
 - ① To cancel unmounting, select <Cancel>.
 - After unmounting, returns to the "SD Card" screen.
5. Hold down [Back] for 1 second to return to the standby screen.
6. Remove the card from the transceiver.

Formatting the microSD card

Use the transceiver's built-in Format function to format all microSD cards to be used with the transceiver. This creates a special folder on the card that you need for operations like loading the data. Format all cards, including a brand new microSD card, and even preformatted cards for PCs or other uses.

NOTE: Formatting a card deletes all its data. Before formatting any used card, back up its data onto your PC. (p. 10-9)

IMPORTANT: Even if you format the microSD card, some data may remain in the card. When you dispose the card, be sure to physically destroy it to avoid unauthorized access to any data that remains.

<Menu operation>

Portable: For the Ten-key and the Simple key types

Mobile: For the LCD types

(Menu > SD Card > **SD Format**)

1. Push [Menu] to display the Menu screen.
2. Push [Left] or [Right] to select "SD Card," then push [OK].



3. Push [Up] or [Down] to select "SD Format," then push [OK].
 - "Are you sure?" is displayed.

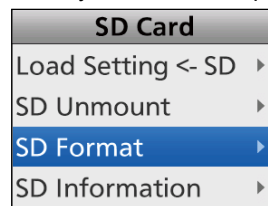

4. Push [Left] or [Right] to select <OK>, then push [OK].
 - ① To cancel formatting, select <Cancel>.
 - After formatting, returns to the "SD Card" screen.
5. Hold down [Back] for 1 second to return to the standby screen.

Loading the saved data files onto a microSD card

You can load the Memory channels and transceiver's settings from the card to a transceiver.

This function is convenient when:

- Setting up from a PC
- Copying the data to another transceiver to operate with the same data.

NOTE: When 2 or more data files are saved in the card, the latest file will be loaded.

TIP: Backing up the current data is recommended before loading other data into the transceiver. (p. 10-9)

<Menu operation>

Portable: For the Ten-key and the Simple key types

Mobile: For the LCD types

(Menu > SD Card > **Load Setting <- SD**)

1. Push [Menu] to display the Menu screen.
2. Push [Left] or [Right] to select "SD Card," then push [OK].



3. Push [Up] or [Down] to select "Load Setting <- SD," then push [OK].
 - "Update Ready Execute?" is displayed.

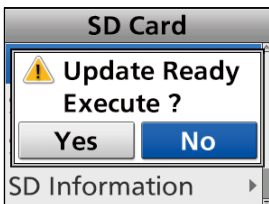
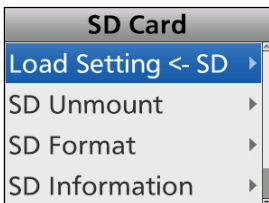

4. Push [Left] or [Right] to select "Yes," then push [OK].
 - Starts the file check.
 - ① While checking the file, "Pre Processing.." and a progress bar are displayed.

5. After checking, the file loading starts.
 - While loading, "Load Setting.." and a progress bar are displayed.
6. After loading ends, the transceiver automatically restarts.

Displaying the information of the microSD card

You can display the microSD card capacity, remaining capacity, and the time remaining for voice recording.

<Menu operation>

Portable: For the Ten-key and the Simple key types

Mobile: For the LCD types

(Menu > SD Card > **SD Information**)

1. Push [Menu] to display the Menu screen.
2. Push [Left] or [Right] to select "SD Card," then push [OK].

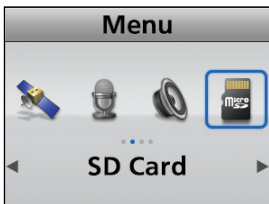

3. Push [Up] or [Down] to select "SD Information," then push [OK].
 - The remaining capacity is displayed.

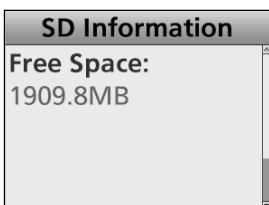
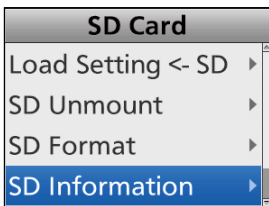

4. Push [Up] or [Down] to select the next screen to display the time remaining for voice recording or the card capacity.

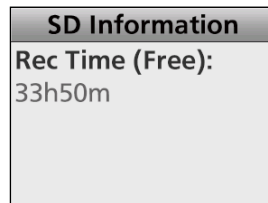

Time remaining for voice recording

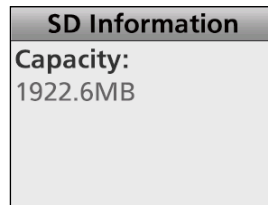

Card capacity

5. Hold down [Back] for 1 second to return to the standby screen.

Backing up the data saved on the microSD card onto a PC

You can easily restore data with a backup file, even if the setting data in the microSD card is accidentally deleted.

◆ About the microSD card's folder contents

The folder in the microSD card contains the following:

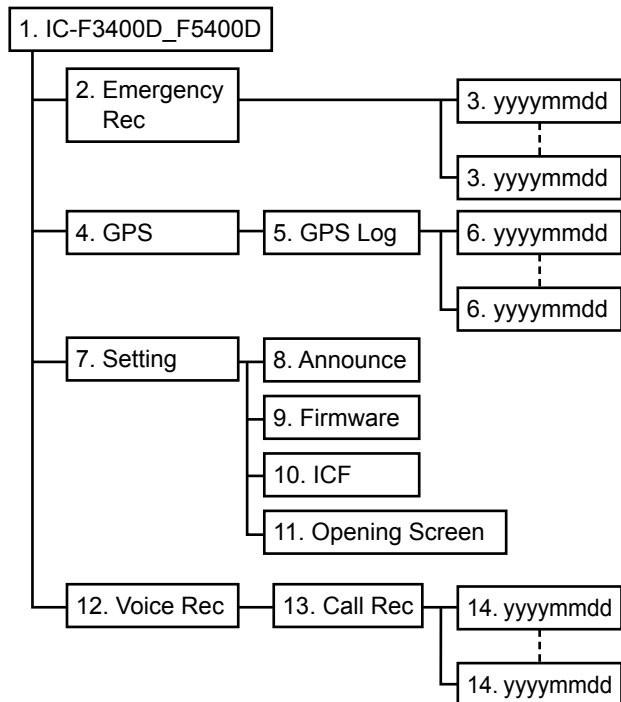

1. IC-F3400D_F5400D folder
The folders created in the transceiver by the Format function are contained in this folder.
2. Emergency Rec folder
The recorded Emergency audio dated folders are created.
3. The dated (yyyyymmdd) folders
The recorded Emergency audio files are saved in the 'wav' format.
The folder name is automatically created in the following date format: yyyyymmdd (yyyy:year, mm:month, dd:day)
4. GPS folder
5. GPS Log folder
The GPS logging dated folders are created.
6. The dated (yyyyymmdd) folders
The GPS logging files (your position) are in the "log" format.
The folder name is automatically created in the following date format: yyyyymmdd (yyyy:year, mm:month, dd:day)
7. Setting folder
8. Announce folder
You can save an audio data for the Announcement function.
9. Firmware folder
The transceiver's firmware file is saved in the 'frm' format.
10. ICF folder
The transceiver's setting data is saved in the 'icf' format.
11. Opening Screen folder
You can save an image file in the 'bmp' format to use as an opening screen that is displayed when turning ON the transceiver. (p. 14-6)
12. Voice Rec folder
The Call Rec folder is created.
13. Call Rec folder
The recorded QSO audio date folders are created.
14. The dated (yyyyymmdd) folders
Recorded audio files are saved in the 'wav' format.
The folder name is automatically created in the following date format: yyyyymmdd (yyyy:year, mm:month, dd:day)

10 ABOUT THE microSD CARD

Backing up the data saved on the microSD card onto a PC

(Example: Selecting the setting data)
When the PC reads the microSD card data, the screens shown below are displayed.

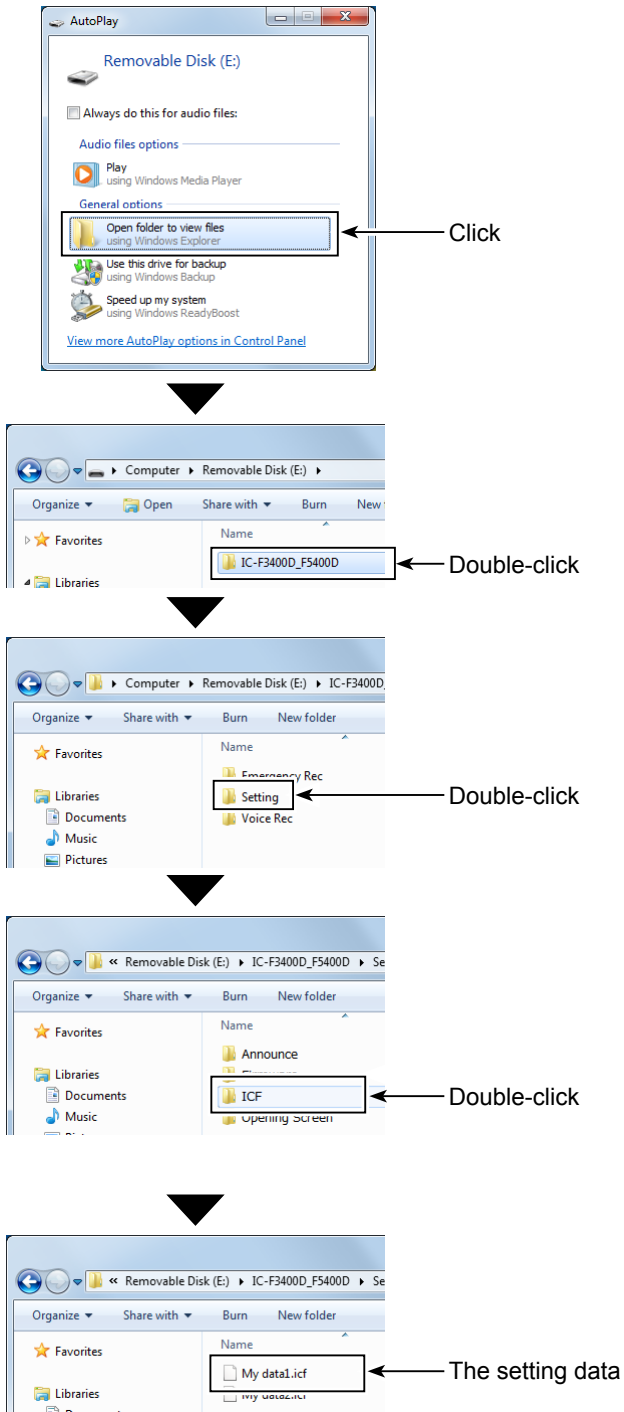

Backing up the data saved on the microSD card onto a PC

◇ Making a backup file on your PC

Windows 7 is used for these instructions.

1. Insert the microSD card into the SD card drive or a memory card reader* on your PC.
Or, connect the transceiver and PC using a USB cable*, then set the “USB Mode Select” item to “Card Reader.” (Menu > Function > **USB Mode Select**)

*User supplied.

2. The “AutoPlay” screen is displayed, as shown to the right.

Click “Open folder to view files.”

- Displays the IC-F3400D_F5400D folder.

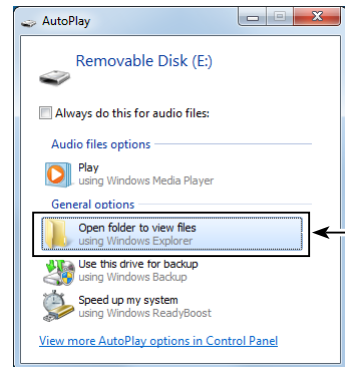

3. Right-click “Removable Disk,” and then click “Copy.”

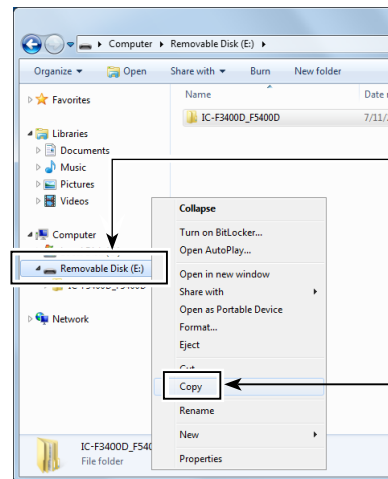

4. Open the desired folder to make a backup file, and then, right-click on the folder.
Then, click “Paste.”
• Pastes the copied microSD card data into the folder.
(Example: Pasting into the “Backup” folder in the C drive)

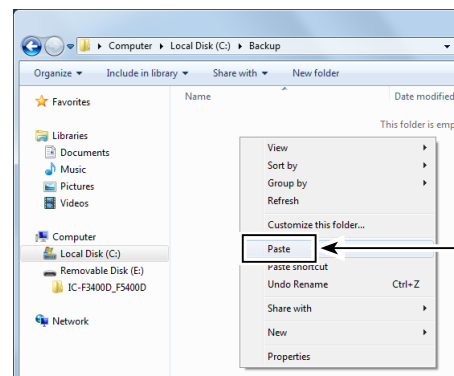

5. When removing the microSD card from your PC, be sure to safely remove it.

① The screen shot shows when a memory card reader is inserted.

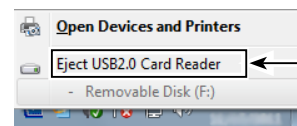

6. After “Safe To Remove Hardware” is displayed, remove the microSD card from your PC.

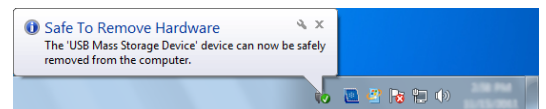

Section 11 VOICE RECORDER FUNCTIONS

Recording a communication audio	11-2
◇ Recording	11-2
Recording Emergency audio	11-4
◇ Recording	11-4
Playing back a recorded audio	11-5
◇ Playing back a recorded communication audio	11-5
◇ Playing back an Emergency audio	11-6
◇ Player screen	11-7
Deleting a file	11-8
Playing back the recorded file on a PC	11-9

Recording a communication audio

This transceiver is equipped with a recorder not only for the receive audio, but also for transmit audio. This function is useful to make a communication record. The recorded audio is saved onto a microSD card. You can start recording by the key operation or the menu operation.

NOTE:

- To record a communication audio, a microSD card (user supplied) is required.
- If your card does not have an "IC-F3400D_F5400D" folder, back up any data on the microSD card. Then insert it in the transceivers card slot and then format it using the transceiver's built-in format function. See page 10-4 for details.
- Once the recording starts, will continue, after the transceiver is turned OFF and ON again.
- The recording will continue until you stop recording or there is no more free space on the microSD card. Depending on the presetting, if there is no more free space on the microSD card, the transceiver automatically deletes the files in the oldest folder to continue the recording.
- When the recording time becomes over 10 minutes, the transceiver continues to record, but records to a new file.
- You can display the microSD card capacity, remaining capacity, and the time remaining for voice recording. See page 10-6 for details.

◇ Recording

<Key operation>

1. Push [Rec Call] to turn ON the Call Recorder function.



- "🔊" is displayed.
2. Push [PTT] to start recording.
 - "🔊" blinks while recording.
 - ① The recording is performed when the mute is released.
 3. Push [Rec Call] again to turn OFF the Call Recorder function.



- "🔊" disappears.

TIP: About recording

- When the recording starts, a folder and file are automatically created on the microSD card.
 - ① The folder name is date formatted yyyyymmdd (yyyy: year, mm: month, dd: day).
 - ① The file name is date formatted yyyyymmdd_hhmmss (yyyy: year, mm: month, dd: day, hh: hour, mm: minute, ss: second).
 - ① The audio files recorded on the same day are saved in the same folder.
- While recording, "🔊" blinks.
- While standing by, the recording pauses.
- While pausing, "🔊" stops blinking.
- "🚫" is displayed when the microSD card has no free space and cannot record additional audio.

Recording a communication audio

◇ Recording (Continued)

<Menu operation>

Portable: For the Ten-key and the Simple key types

Mobile: For the LCD type

(Menu > Voice Rec > **Call Recorder**)

1. Push [Menu] to display the Menu screen.
2. Push [Left] or [Right] to select "Voice Rec," then push [OK].



3. Push [Up] or [Down] to select "Call Recorder," then push [OK].

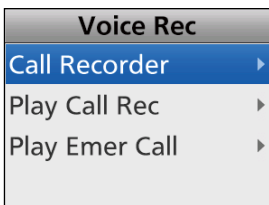

- The "Call Recorder" screen is displayed.
- "Rec Start" is displayed in the screen.

4. Push [OK] to turn ON the Call Recorder function.

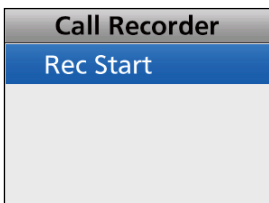

- Automatically returns to the standby screen.
 - "☐" is displayed.
5. Push [PTT] to start recording.
 - "☐" blinks while recording.
 - ① The recording is performed when the mute is released.
 6. Do steps 1 ~ 3 to display the "Call Recorder" screen.
 - ① While recording, "Rec Stop" is displayed in the screen.

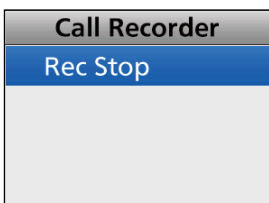

7. Push [OK] to turn OFF the Call Recorder function.
 - Automatically returns to the standby screen.
 - "☐" disappears.

Recording Emergency audio

The transceiver always records the audio in the Emergency mode when pushing [PTT], receiving the Emergency call, or with the Auto TX function.

The recorded audio is saved onto a microSD card.



NOTE:

- To record Emergency audio, a microSD card (user supplied) is required.
- If your card does not have an “IC-F3400D_F5400D” folder, back up any data on the microSD card, insert it in the transceivers card slot and then format it using the transceiver’s built-in format function. See page 10-4 for details.
- When the recording time becomes 10 minutes, the transceiver continues to record, but record to a new file.
- You can display the microSD card capacity, remaining capacity, and the time remaining for voice recording. See page 10-6 for details.

◇ Recording

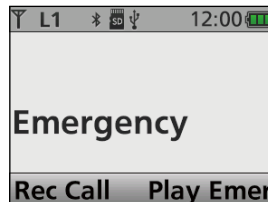
1. Enter the Emergency mode. (p. 4-3)



2. Push [PTT] to start recording.
 - “” blinks while recording.
 - ① The recording is performed when the mute is released.
3. Release [PTT] to stop recording.
 - “” disappears.

TIP: About recording

- When the recording starts, a folder and file are automatically created on the microSD card.
 - ① The folder name is date formatted yyyyymmdd (yyyy: year, mm: month, dd: day).
 - ① The file name is date/time formatted yyyyymmdd_hhmmss (yyyy: year, mm: month, dd: day, hh: hour, mm: minute, ss: second).
 - ① The audio files recorded on the same day are saved in the same folder.

Playing back a recorded audio

◇ Playing back a recorded communication audio

You can playback the recorded communication audio.

<Key operation>

1. Push [Play Call].
 - The folder list is displayed.
2. Push [Up] or [Down] to select a folder that contains the file you want to playback, then push [OK].

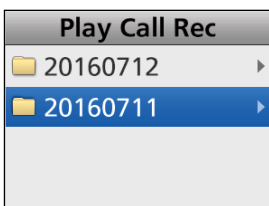

• The file list is displayed.

3. Push [Up] or [Down] to select a file, then push [OK].

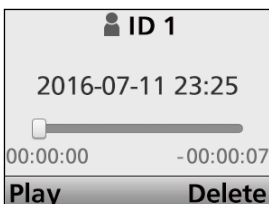
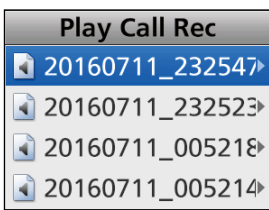

• The player screen is displayed.

① You can select a previous or later file by pushing [Up] or [Down].

4. Push [Play] to start a playback.

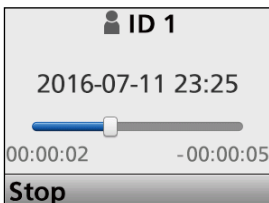

While playing back

① See page 11-7 for details of the operation while playing back.

5. Hold down [Back] for 1 second to return to the standby screen.

TIP: Pushing [Last Play Call] plays back the last recorded communication audio. (p. 2-21)

<Menu operation>

Portable: For the Ten-key and the Simple key types

Mobile: For the LCD type

(Menu > Voice Rec > **Play Call Rec**)

1. Push [Menu] to display the Menu screen.
2. Push [Left] or [Right] to select "Voice Rec," then push [OK].

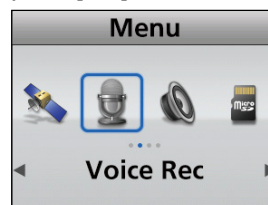

3. Push [Up] or [Down] to select "Play Call Rec," then push [OK].

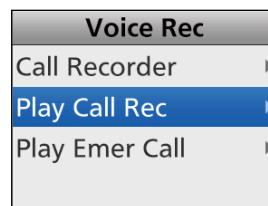

• The folder list is displayed.

4. Push [Up] or [Down] to select a folder that contains the file you want to playback, then push [OK].

• The file list is displayed.

5. Push [Up] or [Down] to select a file, then push [OK].

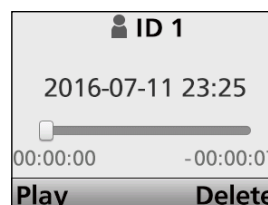
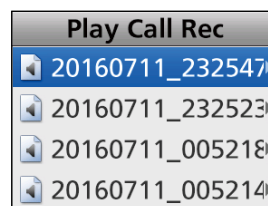

• The player screen is displayed.

① You can select a previous or next file by pushing [Up] or [Down].

6. Push [Play] to start a playback.

① See page 11-7 for details of the operation while playing back.

7. Hold down [Back] for 1 second to return to the standby screen.

Playing back a recorded audio

◇ Playing back an Emergency audio

You can playback the recorded Emergency audio.

<Key operation>

1. Push [Play Emer].
 - The folder list is displayed.
2. Push [Up] or [Down] to select a folder that contains the file you want to playback, then push [OK].

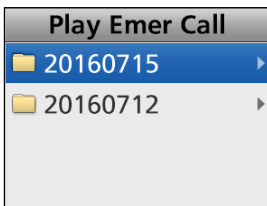

• The file list is displayed.

3. Push [Up] or [Down] to select a file, then push [OK].

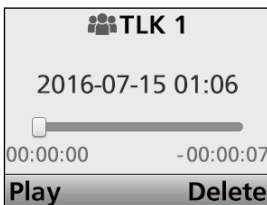
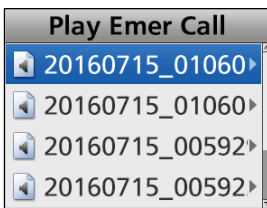

• The player screen is displayed.

① You can select a previous or later file by pushing [Up] or [Down].

4. Push [Play] to start a playback.

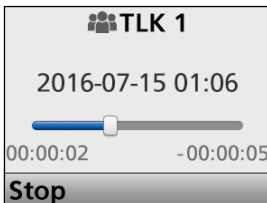

While playing back

① See page 11-7 for details of the operation while playing back.

5. Hold down [Back] for 1 second to return to the standby screen.

TIP: Pushing [Last Play Call] plays back the last recorded communication audio. (p. 2-21)

<Menu operation>

Portable: For the Ten-key and the Simple key types

Mobile: For the LCD type

(Menu > Voice Rec > **Play Emer Call**)

1. Push [Menu] to display the Menu screen.
2. Push [Left] or [Right] to select "Voice Rec," then push [OK].

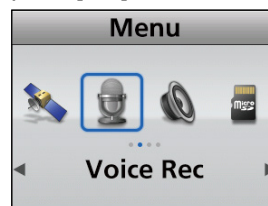

3. Push [Up] or [Down] to select "Play Emer Call," then push [OK].

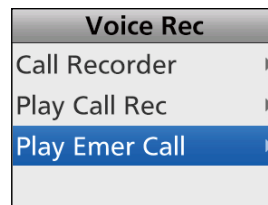

• The folder list is displayed.

4. Push [Up] or [Down] to select a folder that contains the file you want to playback, then push [OK].

• The file list is displayed.

5. Push [Up] or [Down] to select a file, then push [OK].

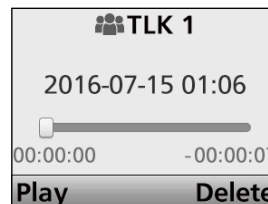
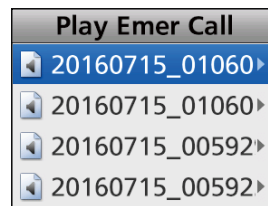

• The player screen is displayed.

① You can select a previous or next file by pushing [Up] or [Down].

6. Push [Play] to start a playback.

① See page 11-7 for details of the operation while playing back.

7. Hold down [Back] for 1 second to return to the standby screen.

Playing back a recorded audio

◇ Player screen

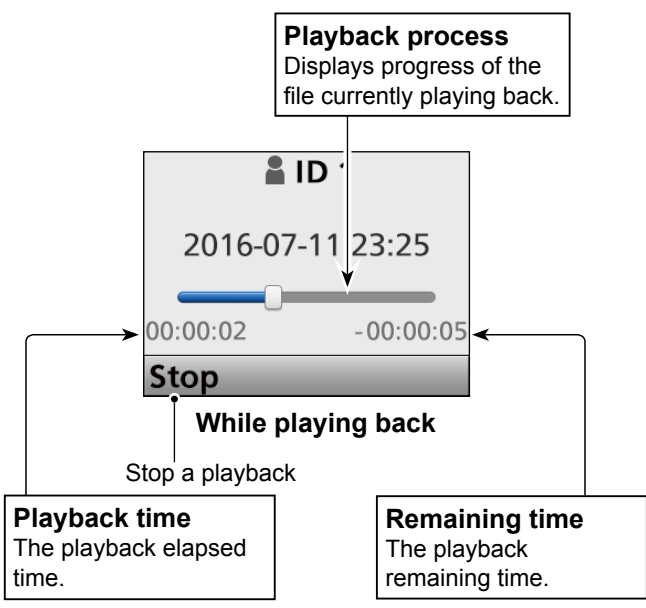
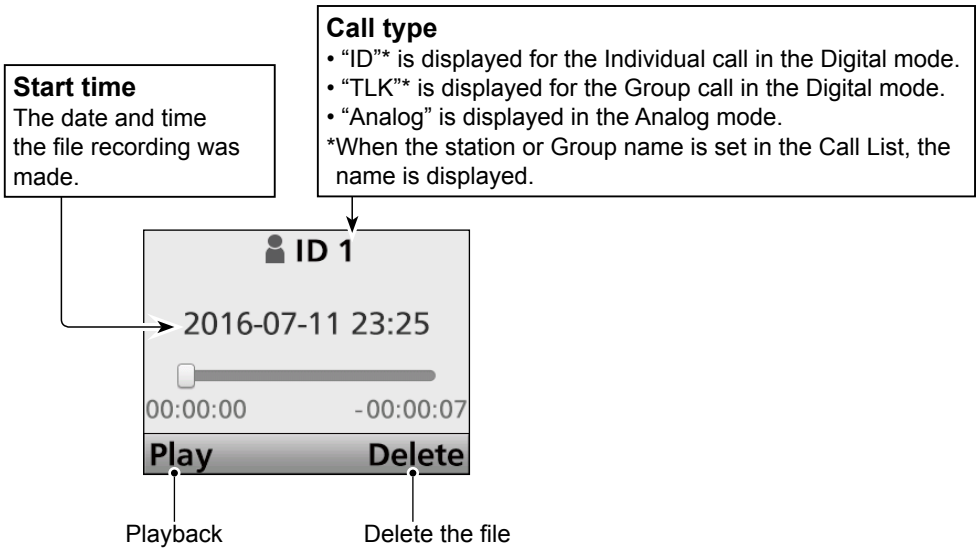

TIP: Operation while playing back

Fast forward while playing back

- Push [Right] to fast forward in 1 second playback steps.
- Hold down [Right] to fast forward in 10 second playback steps until you release [Right].

Rewind while playing back

- Push [Left] to rewind in 1 second playback steps.
- Hold down [Left] to rewind in 10 second playback steps until you release [Left].

Stop the playing
Push [Stop].

Deleting a file

You can delete a recorded audio file.

NOTE: Depending on the presetting, the user cannot delete a recorded audio file.
 ① CS-F3400D PROGRAMMING SOFTWARE
 (Supplemental - Voice Record/Play - **Call Rec Protection**)

<Key operation>

1. Push [Play Call].
 - The folder list is displayed.
2. Push [Up] or [Down] to select a folder that contains the file you want to delete, then push [OK].

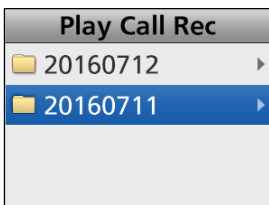

• The file list is displayed.

3. Push [Up] or [Down] to select a file to delete, then push [OK].

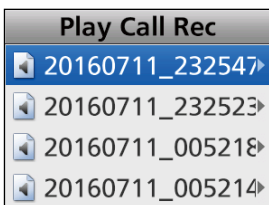

• The player screen is displayed.

4. Push [Delete].

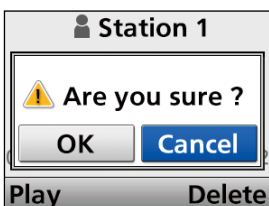
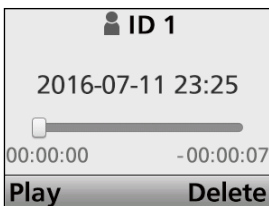

5. Push [Left] or [Right] to select <OK>, then push [OK].
 - The selected file is deleted.
6. Hold down [Back] for 1 second to return to the standby screen.

<Menu operation>

Portable: For the Ten-key and the Simple key types

Mobile: For the LCD type

(Menu > Voice Rec > **Play Call Rec**)

1. Push [Menu] to display the Menu screen.
2. Push [Left] or [Right] to select "Voice Rec," then push [OK].



3. Push [Up] or [Down] to select "Play Call Rec," then push [OK].

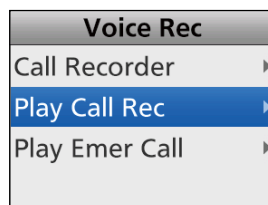

• The folder list is displayed.

4. Push [Up] or [Down] to select a folder that contains the file you want to delete, then push [OK].
 - The file list is displayed.
5. Push [Up] or [Down] to select a file to delete, then push [OK].
 - The player screen is displayed.
6. Push [Delete].

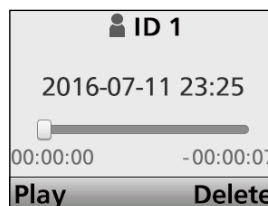

7. Push [Left] or [Right] to select <OK>, then push [OK].
 - The selected file is deleted.
8. Hold down [Back] for 1 second to return to the standby screen.

Playing back the recorded file on a PC

You can also playback the voice memory data on a PC.

① Microsoft® Windows® 7 is used for the description below.

1. Insert the microSD card into the card drive or a memory card reader on your PC.
2. When the microSD card is recognized by the PC, the Auto Play window is displayed, as shown to the right. Click “Open folder to view files.”
 - The “IC-F3400D_F5400D” folder is displayed.
3. Double-click the “IC-F3400D_F5400D” folder.
4. Double-click the “Voice Rec” folder.
5. Double-click the “Call Rec” folder.
6. Double-click the folder where the file you want to playback is saved.
(Example: 20160712 folder)
7. To playback the file, double-click it.
(Example: 20160712_120000.wav)

NOTE:

- The playback method may differ, depending on the application. Refer to the application’s instruction manual for details.
- If the file does not playback, even if you double click the file, download an appropriate application. (Example: Windows Media® Player)

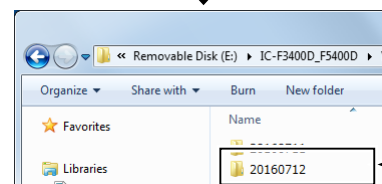
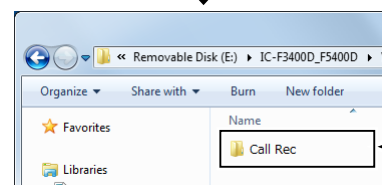
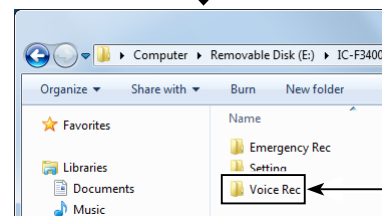
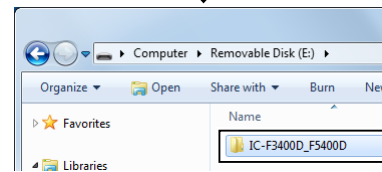
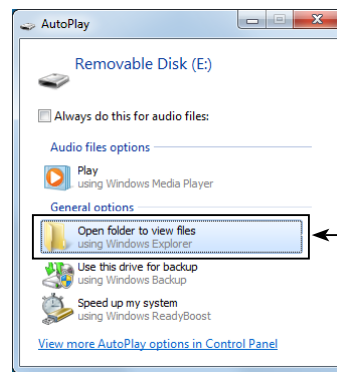

Section 12 Bluetooth® OPERATION

Bluetooth® Wireless Technology operation.....	12-2
◇ Electromagnetic Interference	12-2
Turning ON the Bluetooth® function	12-3
◇ For the Portable Ten-key and Simple key types and Mobile LCD types.....	12-3
◇ For the Portable Non-display types and Mobile Segment types...	12-4
Pairing with a headset	12-6
Headset settings.....	12-8
◇ AF Output (Menu > Bluetooth > BT Audio Setting)	12-8
◇ About the VS-3 headset.....	12-8
Pairing with a data device.....	12-9
Accepting a pairing request from a Bluetooth® device	12-11
Disconnecting from a Bluetooth® device	12-13
Deleting a Bluetooth® device from the pairing list.....	12-14
Resetting the installed Bluetooth® unit	12-15
◇ For the Portable Ten-key and Simple key types and Mobile LCD types.....	12-15
◇ For the Portable Non-display types and Mobile Segment types.	12-16
The maximum number of paired devices	12-17

Bluetooth® Wireless Technology operation

You can connect to other Bluetooth® wireless technology enabled devices (Headset or Data) with the installed Bluetooth® unit.

• Icom Headset

When you connect the optional VS-3 Bluetooth® HEADSET to the transceiver, you can wirelessly transmit and receive the headset audio. The VS-3 has a [PTT] switch, so you can transmit in the same way as using the transceiver's [PTT] switch. The VOX function can also be used, so you can toggle transmit and receive by your voice through the headset.

You can assign a desired key function to the keys on the side panel of the VS-3 to remotely operate the transceiver.

• Third party Headset

When you connect a third party's Bluetooth® headset to the transceiver, you can wirelessly transmit and receive the audio.

• PC with Bluetooth®

When you connect a PC with Bluetooth® to a transceiver, you can set it up using the optional programming software.

The communication range of Bluetooth® is approximately 10 meters (33 feet).

NOTE: The Bluetooth® communication range may vary, depending on the environment in which the device operates. Microwave ovens or a Wireless LAN may cause an interference. In that case, stop using those devices or move away from them. The Bluetooth® device has a range of use. If the communication is unstable, use the device within the range.

◇ Electromagnetic Interference

When you use a Bluetooth® device, pay attention to the following:

Bluetooth® devices operate in the 2.4 GHz band. The 2.4 GHz band is also used by other devices, such as Wireless LAN products, microwave ovens, RFID systems, amateur radio stations, and so on. When using this device near such devices, interference may occur, causing a decrease in communication speed, and an unstable connection. In such cases, use this device away from the other devices, or stop using those devices.

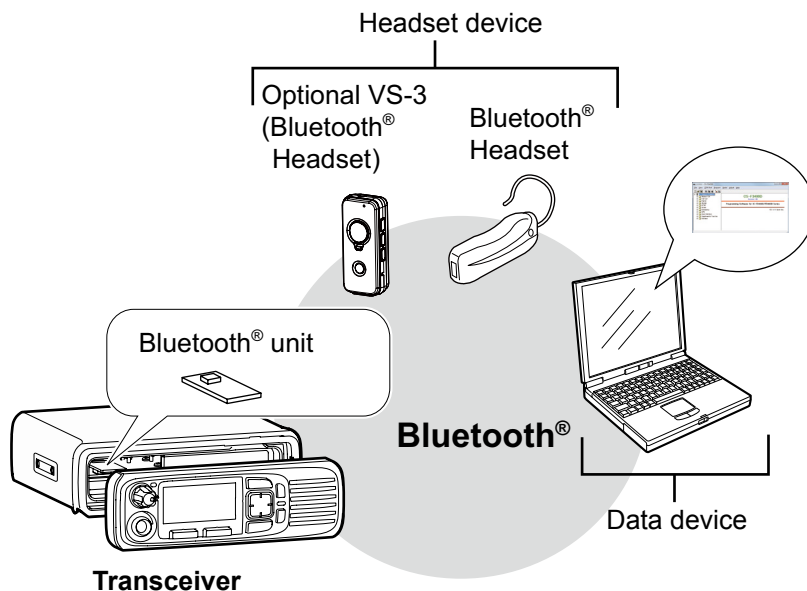

Turning ON the Bluetooth® function

◇ For the Portable Ten-key and Simple key types and Mobile LCD types

This section describes how to turn ON the Bluetooth® function using the Portable Ten-key and the Simple key types or Mobile LCD types.

NOTE: For the Portable Non-display type and Mobile Segment types
To turn ON the Bluetooth® function, see page 12-4.

<Menu operation>

(Menu > Bluetooth > **Bluetooth**)

1. Push [Menu] to display the “Menu” screen.
2. Push [Left] or [Right] to select “Bluetooth,” then push [OK].



3. Push [Up] or [Down] to select “Bluetooth,” then push [OK].



4. Push [Up] or [Down] to select “ON,” then push [OK].

- The Bluetooth® function is turned ON.

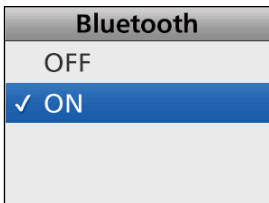

5. Hold down [Back] for 1 second to return to the standby screen.

<Key operation>

1. Push [Bluetooth] to turn ON the Bluetooth® function.

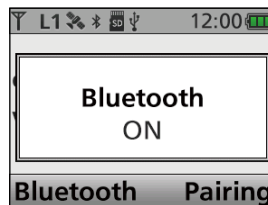

2. Push [Bluetooth] again to turn OFF the Bluetooth® function.

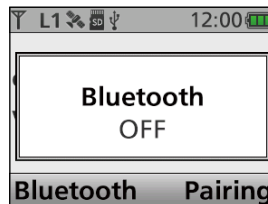

Turning ON the Bluetooth® function

◇ For the Portable Non-display types and Mobile Segment types

This section describes how to turn ON the Bluetooth® function and start pairing using the Portable Non-display types or Mobile Segment types.

NOTE: For the Portable Ten-key and the Simple key types and Mobile LCD types

- To turn ON the Bluetooth® function: See page 12-3
- To pair with a headset: See page 12-6
- To pair with a data device: See page 12-9

Portable:

Step 1: Entering the Bluetooth® Set mode (Transceiver)

1. Turn OFF the transceiver.
2. Set [Selector] to any channel other than Channel 16.
3. While holding down [F1], turn ON the transceiver. Continue holding down [F1] for about 3 seconds.
 - 2 beeps sound.
 - The transceiver enters the Bluetooth® Set mode.

Step 2: Entering the Pairing mode (Bluetooth® device)

- ① See the Bluetooth® device's instruction manual for details.

Step 3: Turning ON the Bluetooth® function (Transceiver)

After the headset has entered the Pairing mode, push [F2] to turn ON the Bluetooth® function.

- The transceiver automatically enters the Pairing mode, and begins searching for a Bluetooth® headset.
- While searching, the status indicator quickly blinks blue.
- ① If the status indicator does not blink after pushing [F2], the transceiver has not entered the Bluetooth® Set mode. In that case, do step 1 again.

Step 4: Pairing with a headset (Transceiver)

When a headset is found, the transceiver pairs with it.

- After the transceiver and the headset pairing has succeeded, the Status indicator slowly blinks blue 3 times. In that case, the connection to the headset has also succeeded.
- ① The transceiver searches for a headset first. After searching for a headset, the transceiver will start searching for a data device. To skip searching for a data device, push [PTT] on the headset.
- ① If the Bluetooth® connection fails, the Status indicator slowly blinks red 3 times. To search for a headset again, push [F3] to turn OFF the Bluetooth® function, then push [F2] to turn it ON again.

Step 5: Pairing with a data device (Transceiver)

1. When a data device is found, the transceiver pairs with it.
 - After the transceiver and the data device pairing has succeeded, the Status indicator slowly blinks blue 3 times. In that case, connection to the data device has also succeeded.
 - ① If the Bluetooth® connection fails, the Status indicator slowly blinks red 3 times. To search for a data device again, push [F3] to turn OFF the Bluetooth® function, then push [F2] to turn it ON again. The transceiver automatically tries to connect.
2. Turn OFF the transceiver, then turn it ON again to exit the Bluetooth® Set mode.

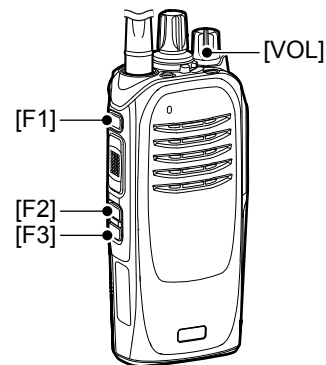

TIP: To turn OFF the Bluetooth® function, push [F3] in the Bluetooth® Set mode.

Turning ON the Bluetooth® function

◇ For the Portable Non-display types and Mobile Segment types (Continued)

Mobile:

Step 1: Entering the Bluetooth® Set mode (Transceiver)

1. Turn OFF the transceiver.
2. While holding down [F2] and [F3], turn ON the transceiver. Continue holding down [F2] and [F3] for about 3 seconds.
 - 2 beeps sound.

Step 2: Entering the Pairing mode (Bluetooth® device)

- ① See the Bluetooth® device's instruction manual for details.

Step 3: Turning ON the Bluetooth® function (Transceiver)

3. After the headset has entered the Pairing mode, hold down [F1] for 1 second to enter the Set mode.
4. Push [F2] or [F3] to select "b0."
5. Push [Up] to turn ON the Bluetooth® function.
 - The transceiver automatically enters the Pairing mode, and begins searching for a Bluetooth® headset.
 - While searching, the status indicator quickly blinks blue.
 - ① If the status indicator does not blink after pushing [Up], the transceiver has not entered the Bluetooth® Set mode. In that case, do steps 1 and 2 again.
 - ① If the transceiver has been paired with a Bluetooth® headset before, the transceiver does not start searching. In that case, the transceiver and the headset are automatically connected.

Step 4: Pairing with a headset (Transceiver)

When a headset is found, the transceiver pairs with it.

- After the transceiver and the headset pairing has succeeded, the Status indicator slowly blinks blue 3 times. In that case, the connection to the headset has also succeeded.
- ① The transceiver searches for a headset first. After searching for a headset, the transceiver will start searching for a data device. To skip searching for a data device, push [PTT] on the headset.
- ① If the Bluetooth® connection fails, the Status indicator slowly blinks red 3 times. To search for a headset again, push [Down] to turn OFF the Bluetooth® function, then push [Up] to turn it ON again.

Step 5: Pairing with a data device (Transceiver)

1. When a data device is found, the transceiver pairs with it.
 - After the transceiver and the data device pairing has succeeded, the Status indicator slowly blinks blue 3 times. In that case, connection to the data device has also succeeded.
 - ① If the Bluetooth® connection fails, the Status indicator slowly blinks red 3 times. To search for a PC again, push [Down] to turn OFF the Bluetooth® function, then push [Up] to turn it ON again. The transceiver automatically tries to connect.
2. Hold down [F1] for 1 second to exit the Set mode.
3. Turn OFF the transceiver, then turn it ON again to normally operate the transceiver.

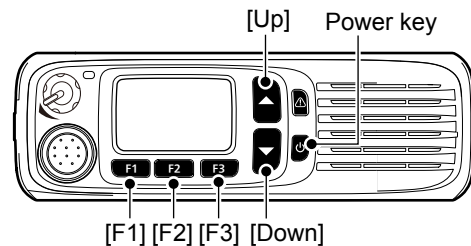

TIP: To turn OFF the Bluetooth® function, push [Down] when "b0" is selected in the Set mode.

Pairing with a headset

This section describes how to pair with a Bluetooth® headset using the Portable Ten-key and the Simple key types or Mobile LCD types.

NOTE: For the Portable Non-display type and Mobile Segment type

To pair with a headset, see page 12-4 for details.

Step 1: Entering the Pairing mode (Headset)

① See the headset's instruction manual for details.

Step 2: Turning ON the Bluetooth® function (Transceiver)

① See page 12-3 for details.

Step 3: Searching for the headset (Transceiver)

1. Push [Menu] to display the "Menu" screen.
2. Push [Left] or [Right] to select "Bluetooth," then push [OK].

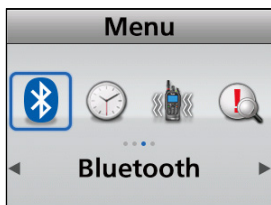

3. Push [Up] or [Down] to select "BT Device List," then push [OK].



4. Push [Up] or [Down] to select "Find Device," then push [OK].

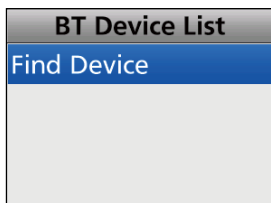

TIP: If the transceiver has been connected to the Bluetooth® device before, its name may be displayed in step 4. In that case, push [Up] or [Down] to select it, then push [OK] to connect.

5. Push [Up] or [Down] to select "Headset," then push [OK] to start searching.

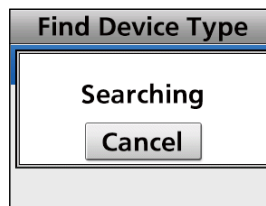
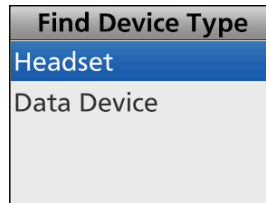

6. When pairable headsets are found, their names are displayed on the screen.

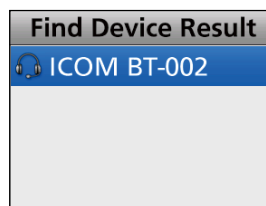

TIP: If the transceiver cannot find any pairable headsets, the following screen is displayed. In that case, do step 4 to search for a headset again.

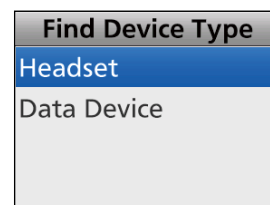

☞ Continued on the next page.

Pairing with a headset

Step 4: Connecting to the headset (Transceiver)

1. Push [Up] or [Down] to select the headset to connect, then push [OK].
 - Connects to the headset.

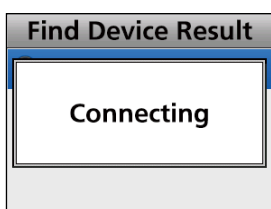
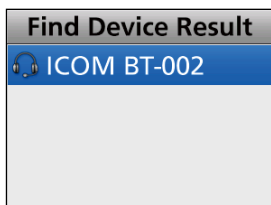

2. After the transceiver and the headset connection has succeeded, "✓" is displayed beside the headset icon.

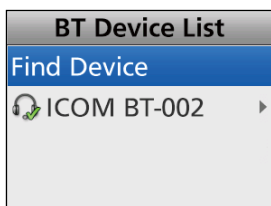

3. Hold down [Back] for 1 second to return to the standby screen.
 - While connected to a Bluetooth® headset, "Bluetooth" is displayed instead of "BT".

TIP: When you turn ON the transceiver, with the "Auto Connect" item is set to ON, the transceiver automatically connects to the last paired device. After connecting, "Bluetooth" is displayed instead of "BT".

NOTE: The transceiver connects to the last connected device, if the connecting operation is performed on the device side, even if the "Auto Connect" item is set to OFF.

Headset settings

◇ AF Output

(Menu > Bluetooth > **BT Audio Setting**)

You can set the audio output device when a Bluetooth® headset is connected.

If the “BT Audio Setting” item is set to “BT & SP,” you can hear audio from both a connected Bluetooth® headset and the transceiver’s speaker.

See page 6-14 for details.

◇ About the VS-3 headset

You can set the detailed settings of the optional VS-3 Bluetooth® HEADSET.

- **Key Beep** (p. 6-14)

(Menu > Bluetooth > **Key Beep (VS-3)**)

Set a beep to sound when you push [PLAY], [FWD] or [RWD] on the VS-3. This setting is different from the transceiver’s beep setting. When both settings are set to “ON,” the beeps sound on the transceiver and the headset.

- **Power Save** (p. 6-14)

(Menu > Bluetooth > **P.Save (VS-3)**)

The Power Save function temporarily disconnects the Bluetooth® connection if no communication or operation is performed for 120 seconds, to prolong the VS-3’s battery life.

- **PTT Beep** (p. 6-14)

(Menu > Bluetooth > **PTT Beep (VS-3)**)

Set a beep to sound when you push [PTT] on the VS-3. This setting is different from the transceiver’s beep setting. When both settings are set to “ON,” the beeps sound on the transceiver and the headset.

- **One-touch PTT** (p. 6-14)

(Menu > Bluetooth > **One-touch PTT**)

The One-Touch PTT function enables you to toggle between transmit and receive by pushing [PTT].

Pairing with a data device

This section describes how to pair with a Bluetooth® data device using the Portable Ten-key and the Simple key types or Mobile LCD types.

NOTE: For the Portable Non-display type and Mobile Segment type

To pairing with a data device, see page 12-4 for details.

Step 1: Entering the Pairing mode (Data device)

① See the data device’s instruction manual for details.

Step 2: Turning ON the Bluetooth® function (Transceiver)

① See page 12-3 for details.

Step 3: Searching for the data device (Transceiver)

1. Push [Menu] to display the “Menu” screen.
2. Push [Left] or [Right] to select “Bluetooth,” then push [OK].



3. Push [Up] or [Down] to select “BT Device List,” then push [OK].



4. Push [Up] or [Down] to select “Find Device,” then push [OK].

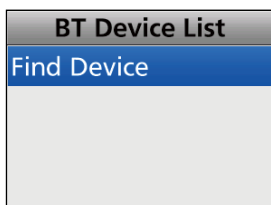

① If the transceiver has been connected to the Bluetooth® device before, its name may be displayed.

5. Push [Up] or [Down] to select “Data Device,” then push [OK] to start searching.

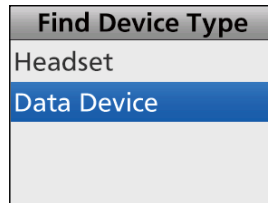

6. When pairable devices are found, their names are displayed on the screen.

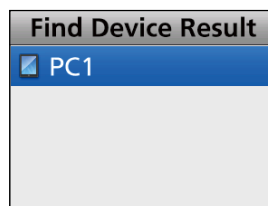

TIP: If the transceiver cannot find any pairable device, the following screen is displayed. In that case, do step 4 to search for a headset again.

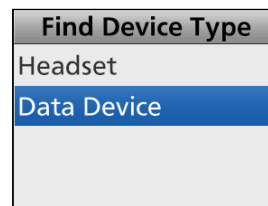

☞ Continued on the next page.

Pairing with a data device

Step 4: Connecting to the data device (Transceiver)

Push [Up] or [Down] to select the data device to connect, then push [OK].

- Connects to the data device.

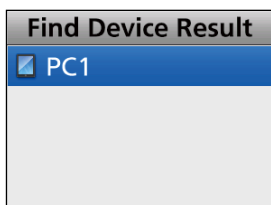

Step 5: Setting the Bluetooth® Serial Port (Data device)

If the Serial Port Access Authorization screen as shown below is displayed, accept it.

- ① The content of screen may differ, depending on the device.
- ① See the device's instruction manual for details.

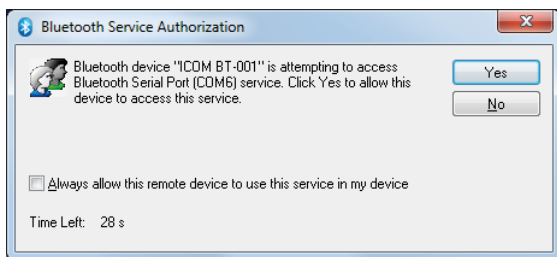

(Example)

Step 6: Connection (Transceiver)

1. After the transceiver and the device connection has succeeded, "✓" is displayed beside the device's icon.

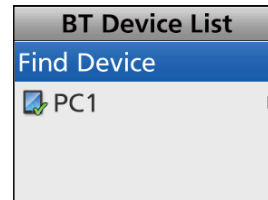

2. Hold down [Back] for 1 second to return to the standby screen.
 - While connected to a Bluetooth® device, "Bluetooth" is displayed instead of "BT".

TIP: When you turn ON the transceiver, with the "Auto Connect" item is set to ON, the transceiver automatically connects to the last paired device. After connecting, "Bluetooth" is displayed instead of "BT".

Accepting a pairing request from a Bluetooth® device

This section describes how to accept a pairing request from a Bluetooth® device.

Portable: For the Ten-key and the Simple key types

Mobile: For the LCD types

Step 1: Preparing the Bluetooth® device

Step 2: Turning ON the Bluetooth® function (Transceiver)

① See page 12-3 for details.

Step 3: Entering the Waiting Pairing mode (Transceiver)

1. Push [Menu] to display the "Menu" screen.
2. Push [Left] or [Right] to select "Bluetooth," then push [OK].



3. Push [Up] or [Down] to select "Waiting Pairing," then push [OK].
 - Enters the Waiting Pairing mode.

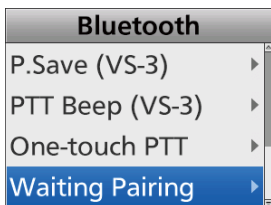

TIP: You can enter the Waiting Pairing mode by pushing [Waiting Pairing].

Step 4: Entering the Pairing mode (Bluetooth® device)

① See the device's instruction manual for details.

Step 5: Sending a Pairing request to the transceiver (Bluetooth® device)

1. The device displays the transceiver's Bluetooth® unit name on the screen.
2. Select the displayed name to send a pairing request.
 - The Bluetooth® device sends a pairing request.
 - ① See the device's instruction manual for details.
 - ① You can confirm the transceiver's Bluetooth® unit name on the "BT Device Info" screen. (p. 6-14)

Step 6: Receiving a Pairing Request (Transceiver)

1. "Passkey? MMMMM" is displayed on the transceiver.
2. Confirm the displayed passkey is the same as yours.
3. Push [Left] or [Right] to select <Accept>, then push [OK].
 - Pairing starts.



4. After the pairing is complete, the device's name is displayed in the "BT Device List" screen.

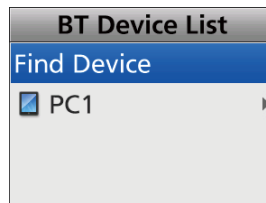

5. Push [Up] or [Down] to select the Bluetooth® device to connect, then push [OK].

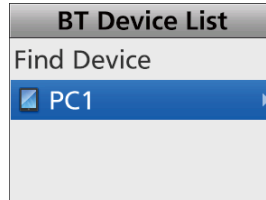

Continued on the next page.

Accepting a pairing request from a Bluetooth® device

- Push [Up] or [Down] to select “Connect,” then push [OK].
 - Connects to the device.

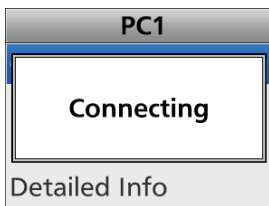
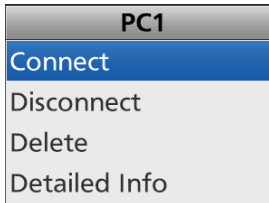

Step 7: Setting the Bluetooth® Serial Port (Bluetooth® device)

If the Serial Port Access Authorization screen as shown below is displayed, accept it.

- The content of screen may differ, depending on the device.
- See the device's instruction manual for details.





(Example)

Step 8: Connection (Transceiver)

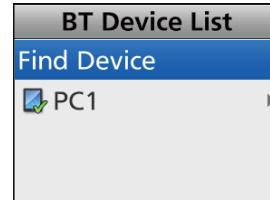
- After the transceiver and the device connection has succeeded, “✓” is displayed beside the device icon.



- Hold down [Back] for 1 second to return to the standby screen.
 - “” is displayed instead of “.

NOTE: When you pair with the third party's headset, entering a PIN code or passkey may be required. See the headset's instruction manual for details.

Disconnecting from a Bluetooth® device

You can disconnect from a Bluetooth® device without cancelling the pairing.

<Menu operation>

Portable: For the Ten-key and the Simple key types

Mobile: For the LCD types

(Menu > Bluetooth > **BT Device List**)

1. Push [Menu] to display the “Menu” screen.
2. Push [Left] or [Right] to select “Bluetooth,” then push [OK].

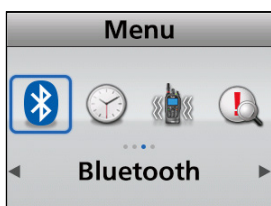

3. Push [Up] or [Down] to select “BT Device List,” then push [OK].



4. Push [Up] or [Down] to select the Bluetooth® device that is currently connected, then push [OK].

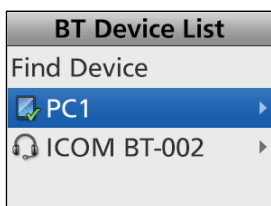

5. Push [Up] or [Down] to select “Disconnect,” then push [OK].

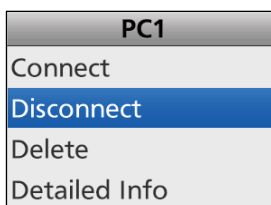

6. The transceiver disconnects from the Bluetooth® device, and “✓” disappears beside the device’s icon.

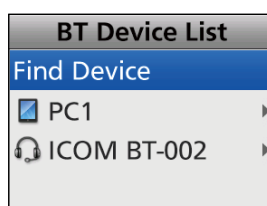

① The transceiver is still paired with the Bluetooth® device.

TIP: You can reconnect to the Bluetooth® device displayed on the screen again by doing the following steps.

1. Push [Up] or [Down] to select the Bluetooth® device to connect, then push [OK].

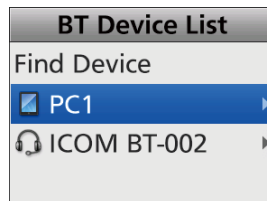

2. Push [Up] or [Down] to select “Connect,” then push [OK].

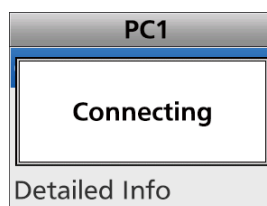
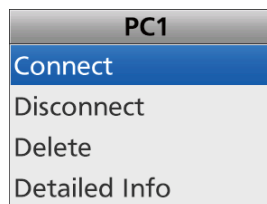

3. Do steps 5 (‘Setting the Bluetooth® Serial Port’) and 6 (‘Connection’) on page 12-10 to connect.

Deleting a Bluetooth® device from the pairing list

You can delete a Bluetooth® device from the “BT Device List” screen. Before deleting a connected Bluetooth® device, disconnect it. (p. 12-13)

<Menu operation>

Portable: For the Ten-key and the Simple key types

Mobile: For the LCD types

(Menu > Bluetooth > **BT Device List**)

1. Push [Menu] to display the “Menu” screen.
2. Push [Left] or [Right] to select “Bluetooth,” then push [OK].



3. Push [Up] or [Down] to select “BT Device List,” then push [OK].



4. Push [Up] or [Down] to select the Bluetooth® device that is currently unconnected, then push [OK].

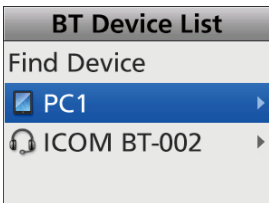

5. Push [Up] or [Down] to select “Delete,” then push [OK].

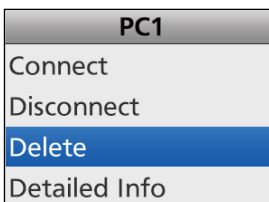

6. The Bluetooth® device is deleted from the list.

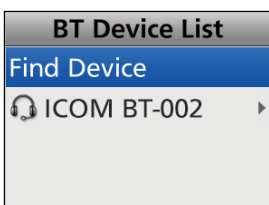

TIP: If you want to connect the deleted device, you must first pair with it again.

- Pairing with a headset: p. 12-6
- Pairing with a data device: p. 12-9

Resetting the installed Bluetooth® unit

◇ For the Portable Ten-key and Simple key types and Mobile LCD types

You can reset the installed Bluetooth® unit. You should reset the unit if you have trouble during Bluetooth® operation.

NOTE: Before resetting, the Bluetooth® function must be turned OFF. Otherwise, resetting cannot be done.

<Menu operation>

(Menu > Bluetooth > **Bluetooth Reset**)

1. Push [Menu] to display the “Menu” screen.
2. Push [Left] or [Right] to select “Bluetooth,” then push [OK].



3. Push [Up] or [Down] to select “Bluetooth Reset,” then push [OK].



4. Push [Left] or [Right] to select <Yes>, then push [OK].



- Resets the Bluetooth® unit’s settings to their factory defaults.
5. Hold down [Back] for 1 second to return to the standby screen.

Resetting the installed Bluetooth® unit

◇ For the Portable Non-display types and Mobile Segment types

NOTE: Before resetting, the Bluetooth® function must be turned OFF. Otherwise, resetting cannot be done.

Portable:

1. Turn OFF the transceiver.
2. Set [Selector] to any channel other than Channel 16.
3. While holding down [F1], turn ON the transceiver. Continue holding down [F1] for about 3 seconds.
 - 2 beeps sound.
 - The transceiver enters the Bluetooth® Set mode.
4. Hold down [F3] for 1 second to reset the Bluetooth® unit's settings to their factory defaults.
5. Turn OFF the transceiver, then turn it ON again to exit the Bluetooth® Set mode.

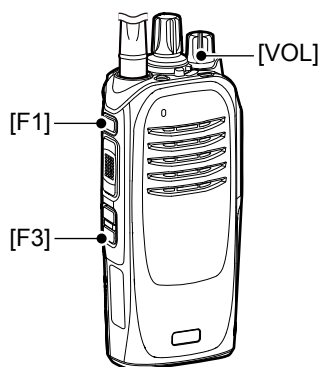

Mobile:

1. Turn OFF the transceiver.
2. While holding down [F2] and [F3], turn ON the transceiver. Continue holding down [F2] and [F3] for about 3 seconds.
 - 2 beeps sound.
3. Hold down [F1] for 1 second to enter the Set mode.
4. Push [F2] or [F3] to select "b0."
5. Hold down [Down] for 1 second to reset the Bluetooth® unit's settings to their factory defaults.
6. Hold down [F1] for 1 second to exit the Set mode.
7. Turn OFF the transceiver, then turn it ON again to normally operate the transceiver.

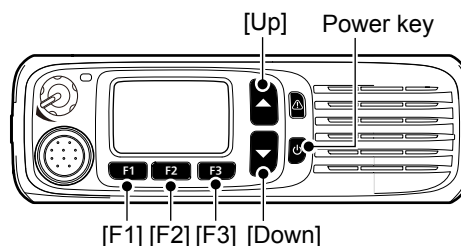

The maximum number of paired devices

You can pair two types of the Bluetooth® devices:
Headset and Data devices.

Up to 8 Bluetooth® devices can be paired with the
installed Bluetooth® unit.

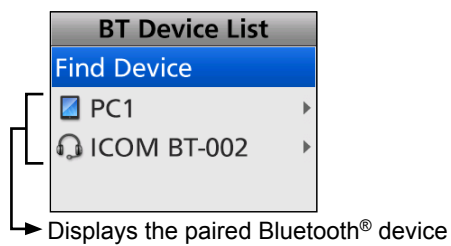

Section 13 USER SETTINGS

Setting the Backlight status	13-2
Setting the Key-touch Beep level	13-3
Setting the Ringer level	13-5
Setting the Squelch level	13-7
Setting the Microphone gain level	13-8
Setting the VOX function	13-9
Setting the VOX Delay.....	13-10
Setting the VOX gain level.....	13-11
Setting the TX Noise Cancel level	13-12
Setting the RX Noise Cancel level.....	13-14

Setting the Backlight status

You can set the Backlight status.

<Menu operation>

Portable: For the Ten-key and the Simple key types

Mobile: For the LCD types

(Menu > Display > **Backlight**)

1. Push [Menu] to display the Menu screen.
2. Push [Left] or [Right] to select "Display," then push [OK].

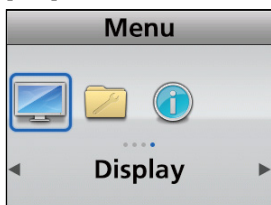

3. Push [Up] or [Down] to select "Backlight," then push [OK].

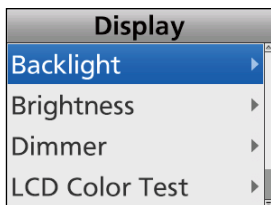

4. Push [Up] or [Down] to select an appropriate option, then push [OK].

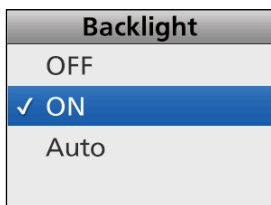

For the Portable types:

- OFF: Turns the Backlight continuously OFF.
- ON: Turns the Backlight continuously ON.
- Auto: When any key except [PTT] is pushed, the Backlight lights for 5 seconds.

For the Mobile types:

- OFF: Turns the Backlight continuously OFF.
- ON: Turns the Backlight continuously ON.
- Auto: Turns the Backlight continuously ON.
When the Dimmer terminal of the D-Sub 25 pin or Option Connector 22 pin is activated, the Backlight lights dimly.

5. Hold down [Back] for 1 second to return to the standby screen.

<Lever switch operation>

Portable: For all types

When [Backlight] is assigned to the Lever switch:

- Slide the Lever switch to the "Φ" position to turn the backlight continuously ON.
- Slide the Lever switch to the "O" position to turn the backlight continuously OFF.

<Key operation>

Portable: For the Ten-key and the Simple key types
Push [Backlight] to select the option.

- OFF: Turns the Backlight continuously OFF.
- ON: Turns the Backlight continuously ON.
- Auto: When any key except [PTT] is pushed, the Backlight lights for 5 seconds.

Mobile: For the LCD types

Push [Backlight] to select the option.

- OFF: Turns the Backlight continuously OFF.
- ON: Turns the Backlight continuously ON.
- Auto: Turns the Backlight continuously ON.
When the Dimmer terminal of the D-Sub 25 pin or Option Connector 22 pin is activated, the Backlight lights dimly.

Mobile: For the Segment types

1. Turn OFF the transceiver.
2. While holding down [F2] and [F3], turn ON the transceiver. Continue holding down [F2] and [F3] for about 3 seconds.
• 2 beeps sound.
3. Hold down [F1] for 1 second to enter the Set mode.
4. Push [F2] or [F3] to display "A0."
5. Push [Up] or [Down] to select the option.
• OFF: Turns the Backlight continuously OFF.
• ON: Turns the Backlight continuously ON.
• Auto: Turns the Backlight continuously ON.
When the Dimmer terminal of the D-Sub 25 pin or Option Connector 22 pin is activated, the Backlight lights dimly.

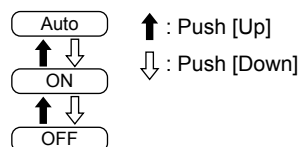

6. Hold down [F1] for 1 second to exit the Set mode.
7. Turn OFF the transceiver, then turn it ON again to normally operate it.

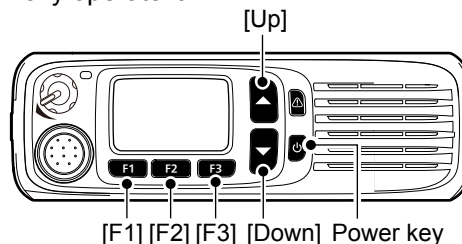

NOTE: When the Brightness or Dimmer* level is set to "0," nothing may be displayed on the segment type screen. In that case, set the Brightness or Dimmer* level using the optional programming software.
*Only when the Dimmer terminal of the D-Sub 25 pin or Option Connector 22 pin is activated.

Setting the Key-touch Beep level

You can set the Key-touch Beep level.
A beep sounds when you operate a key.

<Menu operation>

Portable: For the Ten-key and the Simple key types

Mobile: For the LCD types

(Menu > Utility > **Key-touch Beep Lv**)

1. Push [Menu] to display the Menu screen.
2. Push [Left] or [Right] to select "Utility," then push [OK].

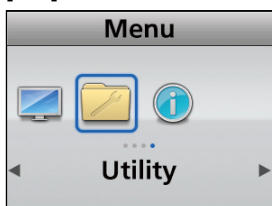

3. Push [Up] or [Down] to select "Key-touch Beep Lv," then push [OK].

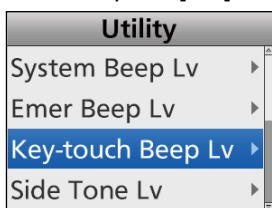

4. Push [Up] or [Down] to set the Key-touch Beep level, then push [OK].

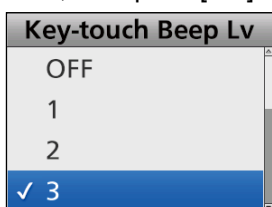

① The setable range is 1 ~ 5, 1 (Linked) ~ 5 (Linked) or OFF.

① When you select a Linked option, the beep level is adjustable by rotating [VOL].

5. Hold down [Back] for 1 second to return to the standby screen.

<Key operation>

Portable: For the Non-display types

1. Turn OFF the transceiver.
2. Set [Selector] to any channel other than Channel 16.
3. While holding down [F3], turn ON the transceiver. Continue holding down [F3] for about 3 seconds.
 - 2 beeps sound.
 - The transceiver enters the Key-touch Beep level Set mode.
4. Push [F2] or [F3] to set the Key-touch Beep level.

① Information

- The setable range is 1 ~ 5, 1 (Linked) ~ 5 (Linked) or OFF.
 - When you select a Linked option, the beep level is adjustable by rotating [VOL].
 - A beep sounds after pushing [F2] or [F3]. An error beep sounds if you try to exceed the setable range.
5. Turn OFF the transceiver, then turn it ON again to exit the Key-touch Beep level Set mode.

Setting order of the Key-touch Beep level

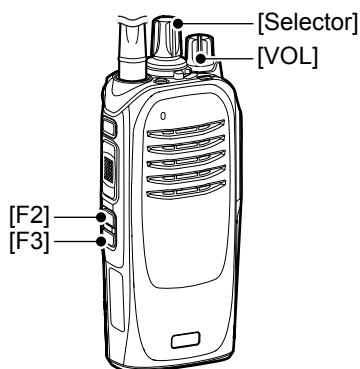
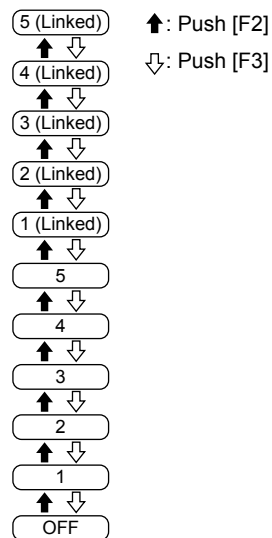

Setting the Key-touch Beep level

<Key operation> (Continued)

Mobile: For the Segment types

1. Turn OFF the transceiver.
2. While holding down [F2] and [F3], turn ON the transceiver. Continue holding down [F2] and [F3] for about 3 seconds.
 - 2 beeps sound.
3. Hold down [F1] for 1 second to enter the Set mode.
4. Push [F2] or [F3] to select the "A1" screen.
5. Push [Up] or [Down] to set the Key-touch Beep level.

Information

- The setable range is 1 ~ 5, 1 (Linked) ~ 5 (Linked) or OFF.
 - When you select a Linked option, the beep level is adjustable by rotating [VOL].
 - A beep sounds after pushing [Up] or [Down]. An error beep sounds if you try to exceed the setable range.
6. Hold down [F1] for 1 second to exit the Set mode.
 7. Turn OFF the transceiver, then turn it ON again to normally operate it.

Setting order of the Key-touch Beep level

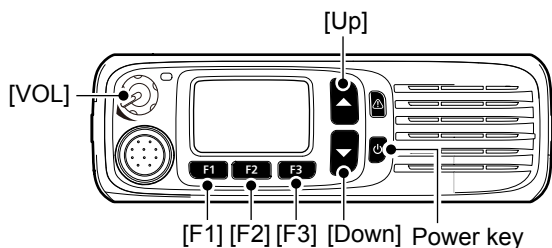
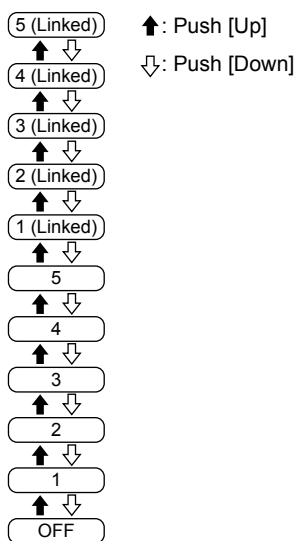

Setting the Ringer level

You can set the Ringer level.
Rings sound when receiving a call.

<Menu operation>

Portable: For the Ten-key and the Simple key types

Mobile: For the LCD types

(Menu > Utility > **Ringer Lv**)

1. Push [Menu] to display the Menu screen.
2. Push [Left] or [Right] to select "Utility," then push [OK].

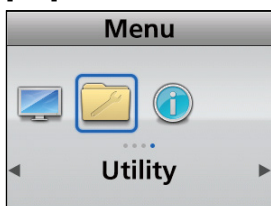

3. Push [Up] or [Down] to select "Ringer Lv," then push [OK].

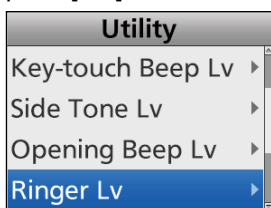

4. Push [Up] or [Down] to set the Ringer level, then push [OK].

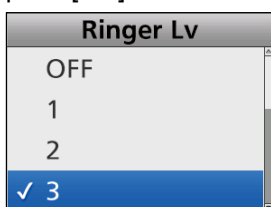

- ① The setable range is 1 ~ 5, 1 (Linked) ~ 5 (Linked) or OFF.
- ① When you select a Linked option, the Ringer level is adjustable by rotating [VOL].
5. Hold down [Back] for 1 second to return to the standby screen.

<Key operation>

Portable: For the Non-display types

1. Turn OFF the transceiver.
2. Set [Selector] to Channel 16.
3. While holding down [F3], turn ON the transceiver. Continue holding down [F3] for about 3 seconds.
 - 2 beeps sound.
 - The transceiver enters the Ringer level Set mode.
4. Push [F2] or [F3] to set the Ringer level.

① Information

- The setable range is 1 ~ 5, 1 (Linked) ~ 5 (Linked) or OFF.
 - When you select a Linked option, the Ringer level is adjustable by rotating [VOL].
 - A beep sounds after pushing [F2] or [F3]. An error beep sounds if you try to exceed the setable range.
5. Turn OFF the transceiver, then turn it ON again to exit the Ringer level Set mode.

Setting order of the Ringer level

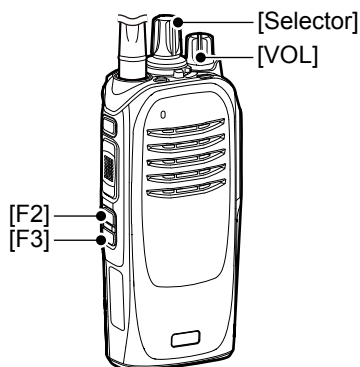
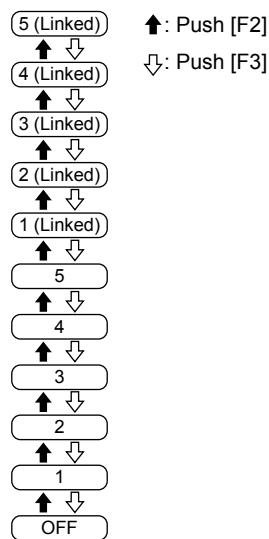

Setting the Ringer level

<Key operation> (Continued)

Mobile: For the Segment types

1. Turn OFF the transceiver.
2. While holding down [F2] and [F3], turn ON the transceiver. Continue holding down [F2] and [F3] for about 3 seconds.
 - 2 beeps sound.
3. Hold down [F1] for 1 second to enter the Set mode.
4. Push [F2] or [F3] to select the "A2" screen.
5. Push [Up] or [Down] to set the Ringer level.

① Information

- The setable range is 1 ~ 5, 1 (Linked) ~ 5 (Linked) or OFF.
 - When you select a Linked option, the Ringer level is adjustable by rotating [VOL].
 - A beep sounds after pushing [Up] or [Down]. An error beep sounds if you try to exceed the setable range.
6. Hold down [F1] for 1 second to exit the Set mode.
 7. Turn OFF the transceiver, then turn it ON again to normally operate it.

Setting order of the Ringer level

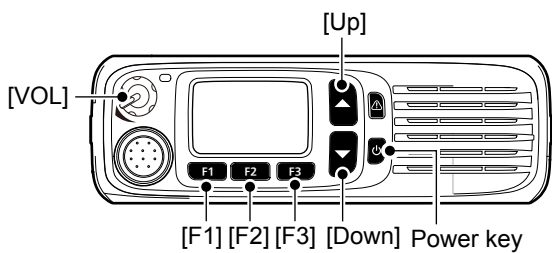
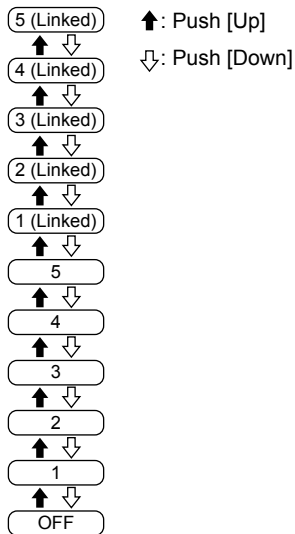

Setting the Squelch level

You can set the Squelch level to between 1 (loose squelch) and 9 (tight squelch), or 0 (open). The squelch circuit mutes the received audio signal, depending on the signal strength.

<Menu operation>

Portable: For the Ten-key and the Simple key types

Mobile: For the LCD types

(Menu > Utility > **SQL Level**)

1. Push [Menu] to display the Menu screen.
2. Push [Left] or [Right] to select "Utility," then push [OK].

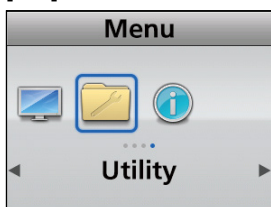

3. Push [Up] or [Down] to select "SQL Level," then push [OK].

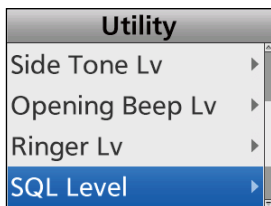

4. Push [Up] or [Down] to set the Squelch level, then push [OK].

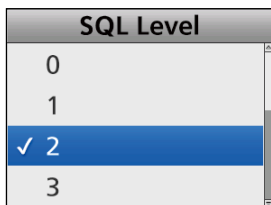

① The setable range is 1 (loose squelch) ~ 9 (tight squelch), or 0 (open).

5. Hold down [Back] for 1 second to return to the standby screen.

<Key operation>

Portable: For the Non-display types

1. Turn OFF the transceiver.
2. Set [Selector] to any channel other than Channel 16.
3. While holding down [F2], turn ON the transceiver. Continue holding down [F2] for about 3 seconds.
 - 2 beeps sound.
 - The transceiver enters the Squelch level Set mode.
4. Push [F2] to increase the Squelch level (tight squelch), or push [F3] to decrease the Squelch level (loose squelch).
 - ① The setable range is 1 (loose squelch) ~ 9 (tight squelch), or 0 (open).
 - ① A beep sounds after pushing [F2] or [F3]. An error beep sounds if you try to exceed the setable range.
5. Turn OFF the transceiver, then turn it ON again to exit the Squelch level Set mode.

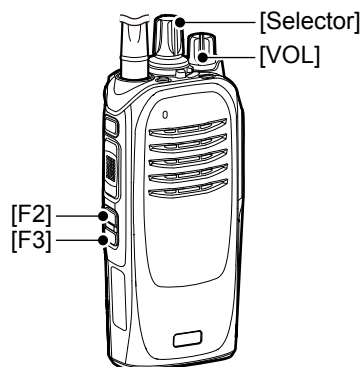

Mobile: For the Segment types

1. Turn OFF the transceiver.
2. While holding down [F2] and [F3], turn ON the transceiver. Continue holding down [F2] and [F3] for about 3 seconds.
 - 2 beeps sound.
3. Hold down [F1] for 1 second to enter the Set mode.
4. Push [F2] or [F3] to select the "A3" screen.
5. Push [Up] to increase the Squelch level (tight squelch), or push [Down] to decrease the Squelch level (loose squelch).
 - ① The setable range is 1 (loose squelch) ~ 9 (tight squelch), or 0 (open).
 - ① A beep sounds after pushing [Up] or [Down]. An error beep sounds if you try to exceed the setable range.
6. Hold down [F1] for 1 second to exit the Set mode.
7. Turn OFF the transceiver, then turn it ON again to normally operate it.

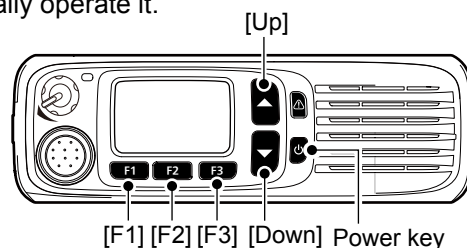

Setting the Microphone gain level

<Menu operation>

Portable: For the Ten-key and the Simple key types

Mobile: For the LCD types

(Menu > Audio Setting > **Mic Gain**)

1. Push [Menu] to display the Menu screen.
2. Push [Left] or [Right] to select "Audio Setting," then push [OK].



3. Push [Up] or [Down] to select "Mic Gain," then push [OK].

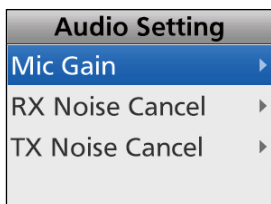

4. Push [Up] or [Down] to set the Microphone gain level, then push [OK].

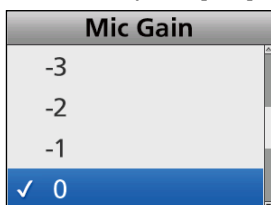

① The setable range is -8 (minimum) ~ +5 (maximum).

5. Hold down [Back] for 1 second to return to the standby screen.

<Key operation>

Portable: For the Non-display types

1. Turn OFF the transceiver.
2. Set [Selector] to Channel 16.
3. While holding down [F2], turn ON the transceiver. Continue holding down [F2] for about 3 seconds.
 - 2 beeps sound.
 - The transceiver enters the Microphone gain level Set mode.
4. Push [F2] to increase, or push [F3] to decrease the gain level.
 - ① The setable range is -8 (minimum) ~ +5 (maximum).
 - ① A beep sounds after pushing [F2] or [F3]. An error beep sounds if you try to exceed the setable range.
5. Turn OFF the transceiver, then turn it ON again to exit the microphone gain level Set mode.

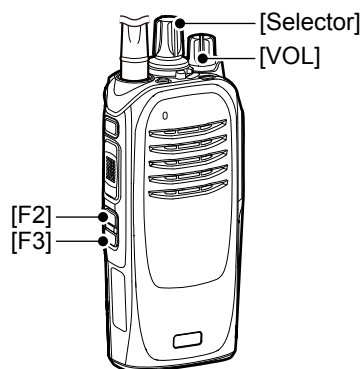

Mobile: For the Segment types

1. Turn OFF the transceiver.
2. While holding down [F2] and [F3], turn ON the transceiver. Continue holding down [F2] and [F3] for about 3 seconds.
 - 2 beeps sound.
3. Hold down [F1] for 1 second to enter the Set mode.
4. Push [F2] or [F3] to select the "A4" screen.
5. Push [Up] to increase, or push [Down] to decrease the gain level.
 - ① The setable range is -8 (minimum) ~ +5 (maximum).
 - ① A beep sounds after pushing [Up] or [Down]. An error beep sounds if you try to exceed the setable range.
6. Hold down [F1] for 1 second again to exit the Set mode.
7. Turn OFF the transceiver, then turn it ON again to normally operate it.

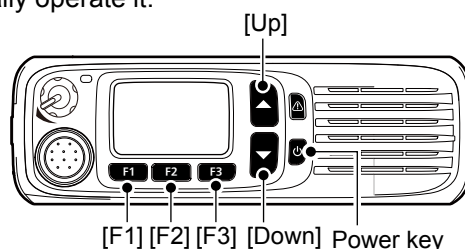

Setting the VOX function

You can turn the VOX function ON or OFF. The VOX function automatically switches between receive and transmit in the voice mode.

<Menu operation>

Portable: For the Ten-key and the Simple key types

Mobile: For the LCD types

(Menu > Functions > **VOX**)

1. Push [Menu] to display the Menu screen.
2. Push [Left] or [Right] to select "Functions," then push [OK].

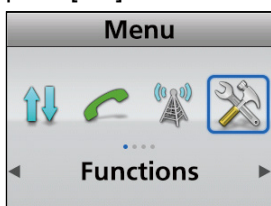

3. Push [Up] or [Down] to select "VOX," then push [OK].

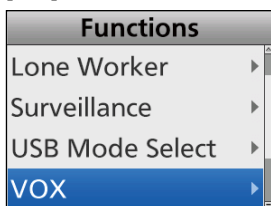

4. Push [Up] or [Down] to turn the VOX function ON or OFF, then push [OK].

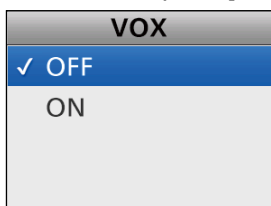

5. Hold down [Back] for 1 second to return to the standby screen.

<Key operation>

Portable: For the Non-display types

1. Turn OFF the transceiver.
2. Set [Selector] to any channel other than Channel 16.
3. While holding down [F1] and [F2], turn ON the transceiver. Continue holding down [F1] and [F2] for about 3 seconds.
 - 2 beeps sound.
 - The transceiver enters the VOX function Set mode.
4. Push [F2] to turn ON, or push [F3] to turn OFF the VOX function.
5. Turn OFF the transceiver, then turn it ON again to exit the VOX function Set mode.

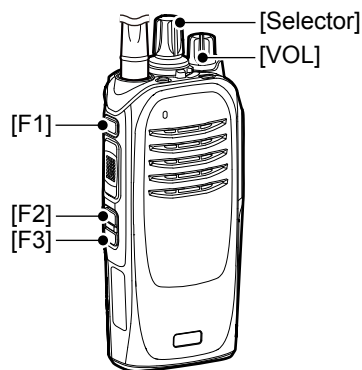

Mobile: For the Segment types

1. Turn OFF the transceiver.
2. While holding down [F2] and [F3], turn ON the transceiver. Continue holding down [F2] and [F3] for about 3 seconds.
 - 2 beeps sound.
3. Hold down [F1] for 1 second to enter the Set mode.
4. Push [F2] or [F3] to select the "A5" screen.
5. Push [Up] to turn ON, or push [Down] to turn OFF the VOX function.
6. Hold down [F1] for 1 second again to exit the Set mode.
7. Turn OFF the transceiver, then turn it ON again to normally operate it.

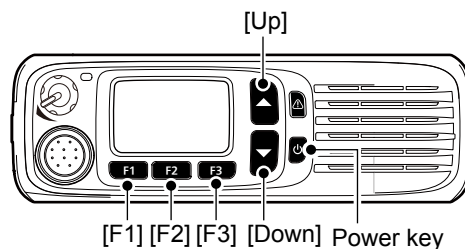

Setting the VOX Delay

The VOX Delay is the period of time the transceiver continues transmitting after the user stops speaking, and then the VOX switches to receive.

<Menu operation>

Portable: For the Ten-key and the Simple key types

Mobile: For the LCD types

(Menu > Functions > **VOX Delay**)

1. Push [Menu] to display the Menu screen.
2. Push [Left] or [Right] to select "Functions," then push [OK].

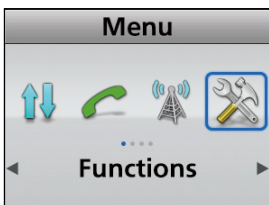

3. Push [Up] or [Down] to select "VOX Delay," then push [OK].

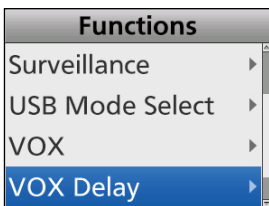

4. Push [Up] or [Down] to set the VOX Delay, then push [OK].

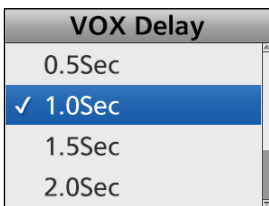

① The setable range is 0.5 ~ 3.0 seconds in 0.5 second steps.

5. Hold down [Back] for 1 second to return to the standby screen.

Setting the VOX gain level

You can set the VOX gain level to between 1 (minimum) and 10 (maximum). Higher values make the VOX function more sensitive to your voice.

<Menu operation>

Portable: For the Ten-key and the Simple key types

Mobile: For the LCD types

(Menu > Functions > **VOX Gain**)

1. Push [Menu] to display the Menu screen.
2. Push [Left] or [Right] to select "Functions," then push [OK].

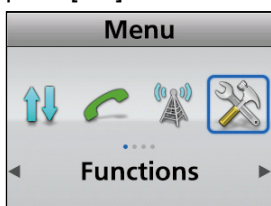

3. Push [Up] or [Down] to select "VOX Gain," then push [OK].

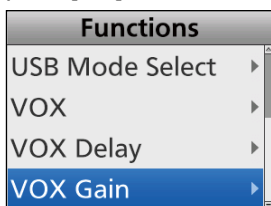

4. Push [Up] or [Down] to set the VOX gain level, then push [OK].

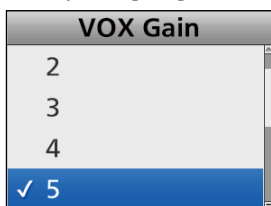

5. Hold down [Back] for 1 second to return to the standby screen.
- ① The setable range is 1 (minimum) ~ 10 (maximum).

<Key operation>

Portable: For the Non-display types

1. Turn OFF the transceiver.
2. Set [Selector] to Channel 16.
3. While holding down [F1] and [F2], turn ON the transceiver. Continue holding down [F1] and [F2] for about 3 seconds.
 - 2 beeps sound.
 - The transceiver enters the VOX gain level Set mode.
4. Push [F2] to increase, or push [F3] to decrease the gain level.
 - ① The setable range is 1 (minimum) ~ 10 (maximum).
 - ① A beep sounds after pushing [F2] or [F3]. An error beep sounds if you try to exceed the setable range.
5. Turn OFF the transceiver, then turn it ON again to exit the VOX gain level Set mode.

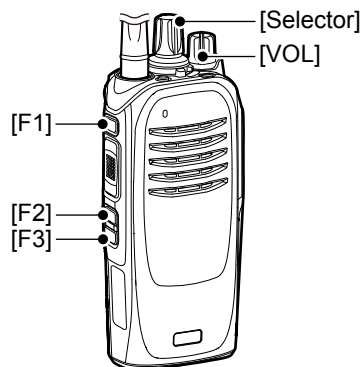

Mobile: For the Segment types

1. Turn OFF the transceiver.
2. While holding down [F2] and [F3], turn ON the transceiver. Continue holding down [F2] and [F3] for about 3 seconds.
 - 2 beeps sound.
3. Hold down [F1] for 1 second to enter the Set mode.
4. Push [F2] or [F3] to select the "A6" screen.
5. Push [Up] to increase, or push [Down] to decrease the gain level.
 - ① The setable range is 1 (minimum) ~ 10 (maximum).
 - ① A beep sounds after pushing [Up] or [Down]. An error beep sounds if you try to exceed the setable range.
6. Hold down [F1] for 1 second again to exit the Set mode.
7. Turn OFF the transceiver, then turn it ON again to normally operate it.

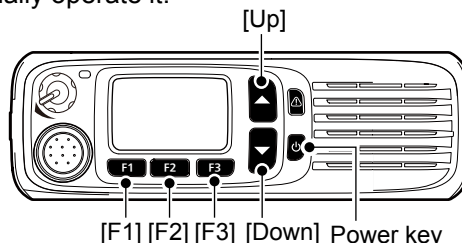

Setting the TX Noise Cancel level

You can set the TX Noise Cancel level to between 1 (minimum) and 3 (maximum), or OFF to suppress the microphone input noise to make the audio easy to hear. Higher values suppress the audio noise more, but the audio quality decreases.

<Menu operation>

Portable: For the Ten-key and the Simple key types

Mobile: For the LCD types

(Menu > Audio Setting > **TX Noise Cancel**)

1. Push [Menu] to display the Menu screen.
2. Push [Left] or [Right] to select "Audio Setting," then push [OK].

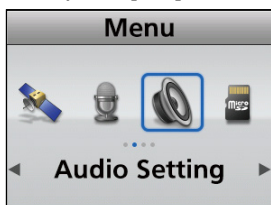

3. Push [Up] or [Down] to select "TX Noise Cancel," then push [OK].

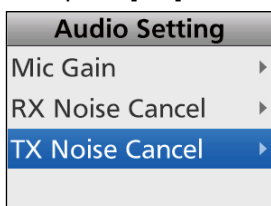

4. Push [Up] or [Down] to set the TX Noise Cancel level.

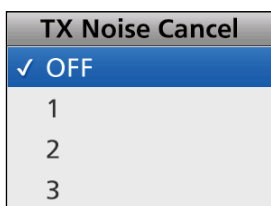

- ① The setable range is 1 ~ 3, or OFF.
- ① When "OFF" is selected, the microphone input noise is not suppressed.

5. Hold down [Back] for 1 second to return to the standby screen.

<Key operation>

Portable: For the Ten-key and the Simple key types

Mobile: For the LCD types

Push [TX Noise Cancel] to set the TX Noise Cancel level.

- ① The setable range is 1 ~ 3, or OFF.
- ① When "OFF" is selected, the microphone input noise is not suppressed.

Portable: For the Non-display types

1. Turn OFF the transceiver.
2. Set [Selector] to any channel other than Channel 16.
3. While holding down [F1] and [F3], turn ON the transceiver. Continue holding down [F1] and [F3] for about 3 seconds.
 - 2 beeps sound.
 - The transceiver enters the TX Noise Cancel level Set mode.
4. Push [F2] to increase, or push [F3] to decrease the TX Noise Cancel level.

① Information

- The setable range is 1 ~ 3, or OFF.
- When "OFF" is selected, the microphone input noise is not suppressed.
- A beep sounds after pushing [F2] or [F3]. An error beep sounds if you try to exceed the setable range.

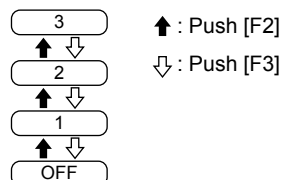

5. Turn OFF the transceiver, then turn it ON again to exit the TX Noise Cancel level Set mode.

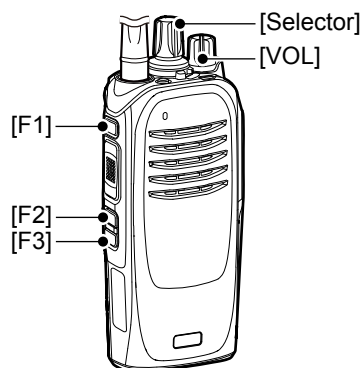

Setting the TX Noise Cancel level

<Key operation> (Continued)

Mobile: For the Segment types

1. Turn OFF the transceiver.
2. While holding down [F2] and [F3], turn ON the transceiver. Continue holding down [F2] and [F3] for about 3 seconds.
 - 2 beeps sound.
3. Hold down [F1] for 1 second to enter the Set mode.
4. Push [F2] or [F3] to select "A7."
5. Push [Up] to increase, or push [Down] to decrease the TX Noise Cancel level.

Information

- The setable range is 1 ~ 3, or OFF.
- When "OFF" is selected, the microphone input noise is not suppressed.
- A beep sounds after pushing [Up] or [Down]. An error beep sounds if you try to exceed the setable range.

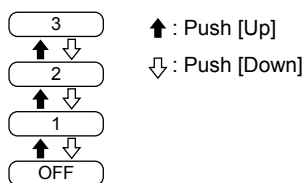

6. Hold down [F1] for 1 second to exit the Set mode.
7. Turn OFF the transceiver, then turn it ON again to normally operate it.

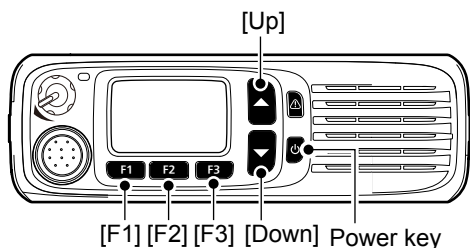

Setting the RX Noise Cancel level

You can set the RX Noise Cancel level to between 1 (minimum) and 3 (maximum), or OFF to suppress the receive audio noise to make the audio easy to hear. Higher values suppress the audio noise more, but the audio quality decreases.

<Menu operation>

Portable: For the Ten-key and the Simple key types

Mobile: For the LCD types

(Menu > Audio Setting > **RX Noise Cancel**)

1. Push [Menu] to display the Menu screen.
2. Push [Left] or [Right] to select "Audio Setting," then push [OK].

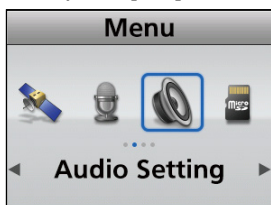

3. Push [Up] or [Down] to select "RX Noise Cancel," then push [OK].

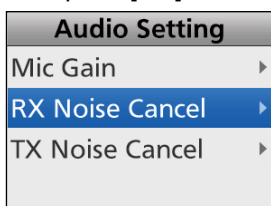

4. Push [Up] or [Down] to set the RX Noise Cancel level.

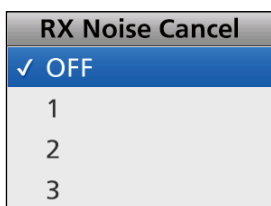

① The setable range is 1 ~ 3, or OFF.

① When "OFF" is selected, the receive audio noise is not suppressed.

5. Hold down [Back] for 1 second to return to the standby screen.

<Key operation>

Portable: For the Ten-key and the Simple key types

Mobile: For the LCD types

Push [RX Noise Cancel] to set the RX Noise Cancel level.

① The setable range is 1 ~ 3, or OFF.

① When "OFF" is selected, the receive audio noise is not suppressed.

Portable: For the Non-display types

1. Turn OFF the transceiver.
2. Set [Selector] to Channel 16.
3. While holding down [F1] and [F3], turn ON the transceiver. Continue holding down [F1] and [F3] for about 3 seconds.
 - 2 beeps sound.
 - The transceiver enters the RX Noise Cancel level Set mode.
4. Push [F2] to increase, or push [F3] to decrease the RX Noise Cancel level.

① Information

• The setable range is 1 ~ 3, or OFF.

• When "OFF" is selected, the receive audio noise is not suppressed.

• A beep sounds after pushing [F2] or [F3]. An error beep sounds if you try to exceed the setable range.

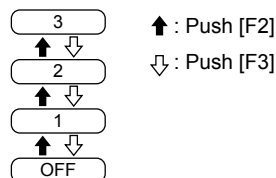

5. Turn OFF the transceiver, then turn it ON again to exit the RX Noise Cancel level Set mode.

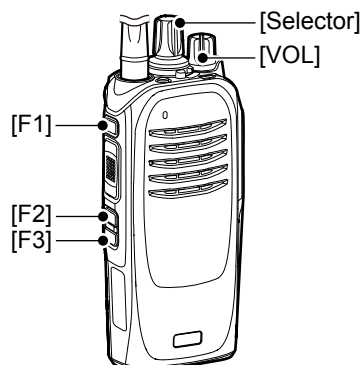

Setting the RX Noise Cancel level

<Key operation> (Continued)

Mobile: For the Segment types

1. Turn OFF the transceiver.
2. While holding down [F2] and [F3], turn ON the transceiver. Continue holding down [F2] and [F3] for about 3 seconds.
 - 2 beeps sound.
3. Hold down [F1] for 1 second to enter the Set mode.
4. Push [F2] or [F3] to select "A8."
5. Push [Up] to increase, or push [Down] to decrease the RX Noise Cancel level.

① Information

- The setable range is 1 ~ 3, or OFF.
- When "OFF" is selected, the receive audio noise is not suppressed.
- A beep sounds after pushing [Up] or [Down]. An error beep sounds if you try to exceed the setable range.

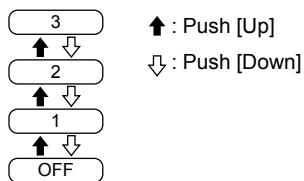

6. Hold down [F1] for 1 second to exit the Set mode.
7. Turn OFF the transceiver, then turn it ON again to normally operate it.

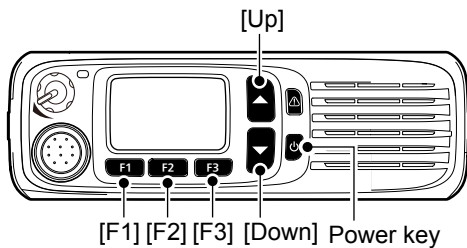

Section 14 OTHERS

Displaying the transceiver's firmware information	14-2
LCD Color Check.....	14-3
Copying data from a transceiver.....	14-4
◇ Connecting.....	14-4
◇ Copying data.....	14-4
Changing the opening screen image.....	14-6
◇ Changing the opening screen image	14-6
◇ Returning to the default setting.....	14-6

Displaying the transceiver's firmware information

You can display the transceiver firmware's information.

<Menu operation>

Portable: For the Ten-key and the Simple key types

Mobile: For the LCD types

(Menu > Information > **Firmware Info**)

1. Push [Menu] to display the Menu screen.
2. Push [Left] or [Right] to select "Information," then push [OK].

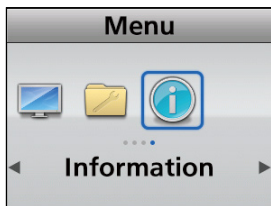

3. Push [Up] or [Down] to select "Firmware Info," then push [OK].

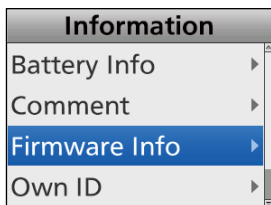

4. Push [Up] or [Down] to display the transceiver's firmware information.
5. Hold down [Back] for 1 second to return to the standby screen.

<Key operation>

Portable: For the Ten-key and the Simple key types

Mobile: For the LCD types

1. Turn OFF the transceiver.
2. While holding down [P1] and [OK], turn ON the transceiver.
 - The transceiver enters the Firmware Information mode.
3. Push [P1] to display the "Firmware Info" screen.
4. Push [Up] or [Down] to display the transceiver's firmware information.
5. Turn OFF the transceiver, then turn it ON again to exit the Firmware Information mode.

LCD Color Check

You can check whether or not the LCD displays color correctly.

<Menu operation>

Portable: For the Ten-key and the Simple key types

Mobile: For the LCD types

(Menu > Display > **LCD Color Test**)

1. Push [Menu] to display the Menu screen.
2. Push [Left] or [Right] to select "Display," then push [OK].

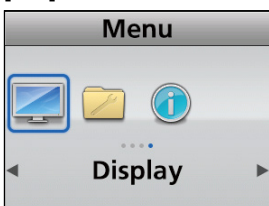

3. Push [Up] or [Down] to select "LCD Color Test," then push [OK].

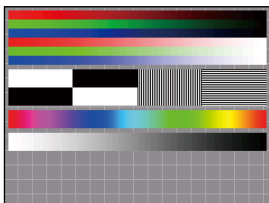
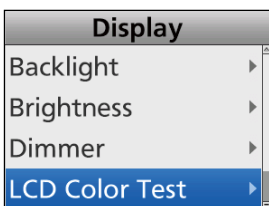

- The transceiver displays the Color Test screen.
4. Hold down [Back] for 1 second to return to the standby screen.

<Key operation>

Portable: For the Ten-key and the Simple key types

Mobile: For the LCD types

1. Turn OFF the transceiver.
2. While holding down [P1] and [Back], turn ON the transceiver.
 - The transceiver enters the LCD Color Test mode.
3. Push [P1] to display the color test screen.

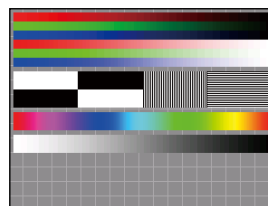

4. Turn OFF the transceiver, then ON again to exit the LCD Color Test mode.

Copying data from a transceiver

This section describes how to copy data from a Master transceiver to a Sub transceiver using the optional OPC-1870 or OPC-2362 ZONE COPY CABLE. The copying procedure differs, depending on the type of the Master transceiver used.

NOTE: Before copying, the “Transceiver Data Out” item must be set to “ON” using the programming software.

◇ Connecting

Before copying, the Master and Sub transceivers should be connected using the optional OPC-1870 or OPC-2362 ZONE COPY CABLE.

1. Turn OFF the Master and Sub transceivers.
2. Connect the two transceivers with the cable. The following cables are used:
 - OPC-1870: Used between a Portable and a Portable.
 - OPC-2362: Used between a Portable and a Mobile.

Portable and Portable connection

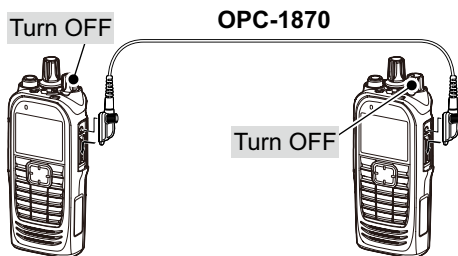

Portable and Mobile connection

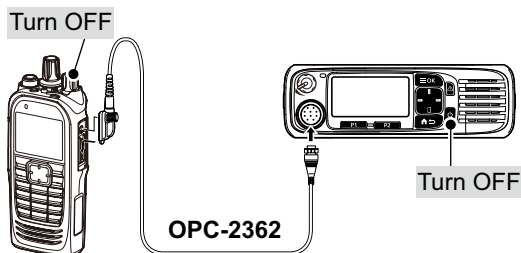

◇ Copying data

**Master: Portable Ten-key or Simple key types
Mobile LCD types**

Step 1: Entering the Programming mode (Master)

1. While holding down [P1] and [Down], turn ON the transceiver. Continue holding down [P1] and [Down] for about 3 seconds.
 - 2 beeps sound.
2. Push [Up] or [Down] to select “Programming.”
 - The transceiver enters the Programming mode.

Step 2: Turning ON the transceiver (Sub)

Step 3: Copying data (Master)

Push the [PTT] (Portable) or Power switch (Mobile) to start copying data to the Sub transceiver.

Step 4: Complete (Master/Sub)

After copying is completed, the Master and Sub transceivers automatically restart.

- The user can operate the Sub transceiver with the loaded data.

Copying data from a transceiver

◇ Copying data (Continued)

Master: Portable Non-display types

Step 1: Entering the Programming mode (Master)

1. Set [Selector] to Channel 16.
2. While holding down [F2] and [F3], turn ON the transceiver. Continue holding down [F2] and [F3] for about 3 seconds.
 - 2 beeps sound.
 - The transceiver enters the Programming mode.

Step 2: Turning ON the transceiver (Sub)

Step 3: Copying data (Master)

Push the [PTT] to start copying data to the Sub transceiver.

Step 4: Complete (Master/Sub)

After copying is completed, the Master and Sub transceivers automatically restart.

- The user can operate the Sub transceiver with the loaded data.

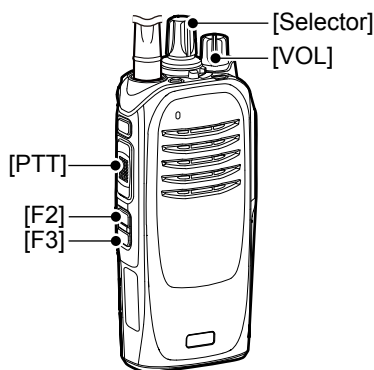

Master: Mobile Segment types

Step 1: Entering the Programming mode (Master)

1. While holding down [F2] and [F3], turn ON the transceiver. Continue holding down [F2] and [F3] for about 3 seconds.
 - 2 beeps sound.
 - The transceiver enters the Programming mode.
2. Hold down [F1] for 1 second to enter the Set mode.
3. Push [F2] or [F3] to select the "C0" screen.
 - The transceiver enters the Programming mode.

Step 2: Turning ON the transceiver (Sub)

Step 3: Copying data (Master)

Push the Power key to start copying data to the Sub transceiver.

Step 4: Complete (Master/Sub)

After copying is completed, the Master and Sub transceivers automatically restart.

- The user can operate the Sub transceiver with the loaded data.

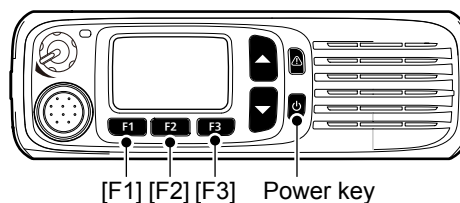

Changing the opening screen image

For only the Portable Ten-key type, Portable Simple key type, or Mobile LCD type transceivers, you can change the opening screen image.

NOTE:

- When Opening Text is entered using the CS-F3400D, the Opening screen is not displayed. (User Interface - Key Assign - Display - **Opening Text**)
- When using the RMK-5 or RMK-7, first connect all the transceivers and microphones, and then turn the transceiver ON or OFF to change the opening screen image.

◇ Changing the opening screen image

1. Connect a transceiver to your PC using the USB cable.
2. Set the **USB Mode Select** to “Card Reader.” (Menu > Function > **USB Mode Select**)
3. Open the Opening Screen folder according to the instructions on page 9-8.
4. Save an image in the Opening Screen folder using your PC. (p. 10-7)

NOTE: The image file has to satisfy the following 3 conditions.

The file format is “24 bit bitmap.”

The file size is

- “318 × 148 pixel” for the Mobile LCD type.
- “294 × 220 pixel” for the Portable Ten-key type, Portable Simple key type, or HM-218.

The file is named as

- “mobile.bmp” for the Mobile LCD type.
- “portable.bmp” for the Portable Ten-key type, Portable Simple key type, or HM-218.

5. Set the **USB Mode Select** to “Data Transfer.” (Menu > Function > **USB Mode Select**)
6. Turn OFF the transceiver.
7. Turn ON the transceiver.
 - The previously set image is displayed first.
 - “User Opening Screen Data Now Loading...” is displayed for a while and then the newly set opening screen is displayed.

◇ Returning to the default setting

1. Connect a transceiver to your PC using the USB cable.
2. Set the **USB Mode Select** to “Card Reader.” (Menu > Function > **USB Mode Select**)
3. Open the Opening Screen folder according to the instructions on page 9-8.
4. Delete an image from the Opening Screen folder.
5. Set the **USB Mode Select** to “Data Transfer.” (Menu > Function > **USB Mode Select**)
6. Turn OFF the transceiver.
7. Turn ON the transceiver.
 - The previously set image is displayed first and the default image is displayed.

Section 15 OPTIONS

HM-218 HAND MICROPHONE (for the Mobile type transceiver)	15-2
◇ Connecting the HM-218	15-2
◇ About the Status indicator	15-2
◇ About the Software key functions	15-2
HM-222 SPEAKER MICROPHONE (for the Portable type transceiver)	15-3
◇ Attaching	15-3
MB-136 BELT CLIP (for the Portable type transceiver)	15-4
◇ MB-136 contents	15-4
◇ Attaching	15-4
◇ Detaching	15-5
LC-184/LC-186 CARRYING CASE (for the Portable type transceiver)	15-6
◇ Types	15-6
◇ Attaching	15-6

HM-218 HAND MICROPHONE (for the Mobile type transceiver)

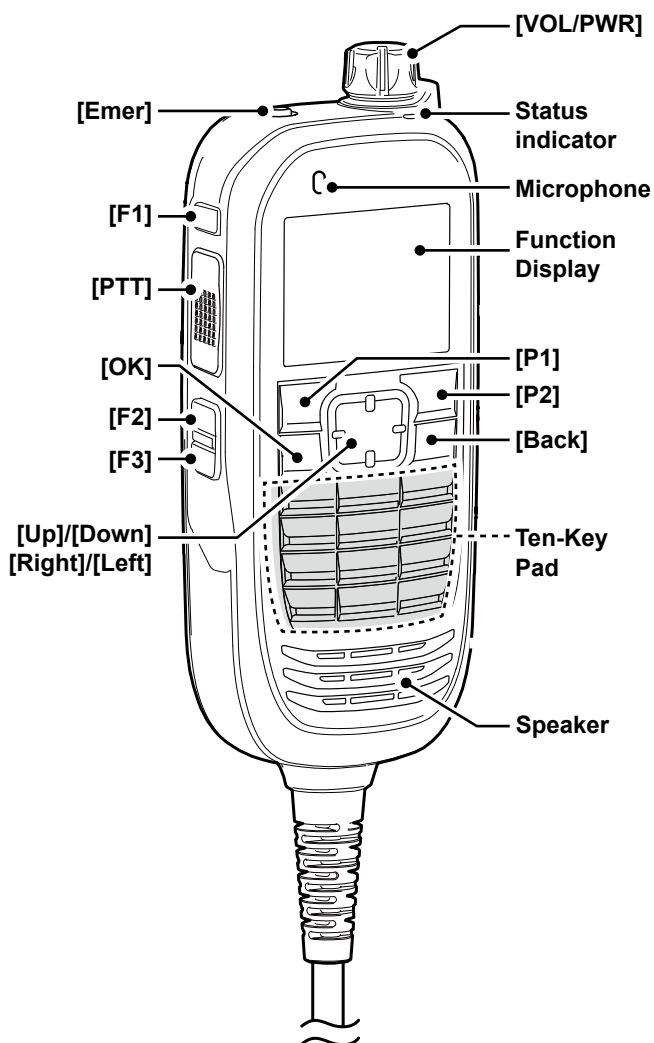

◇ About the Status indicator

- Lights red while transmitting.
- Lights green while receiving a signal, or when the squelch is open.

◇ About the Software key functions

NOTE: Dealers can assign the Software key functions to the keys, and keypad.

① See page 2-12 for details.

◇ Connecting the HM-218

Connect the HM-218 to the optional RMK-5 SEPARATION KIT using the OPC-2364 SEPARATION CABLE for convenient operation.

① See the RMK-5 instruction manual for details.

1. Connect the microphone cable to the OPC-2364's MIC connector, as shown to the right.
2. Push [VOL/PWR] on the HM-218 to turn ON the transceiver.

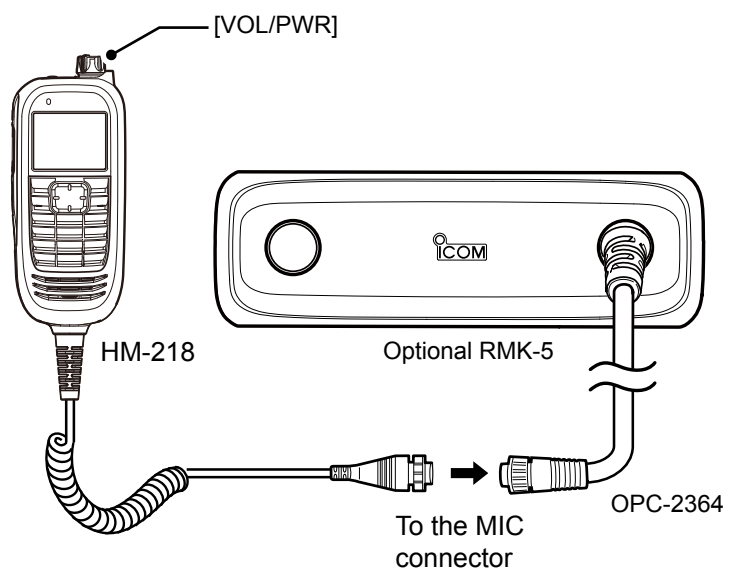

HM-222 SPEAKER MICROPHONE (for the Portable type transceiver)

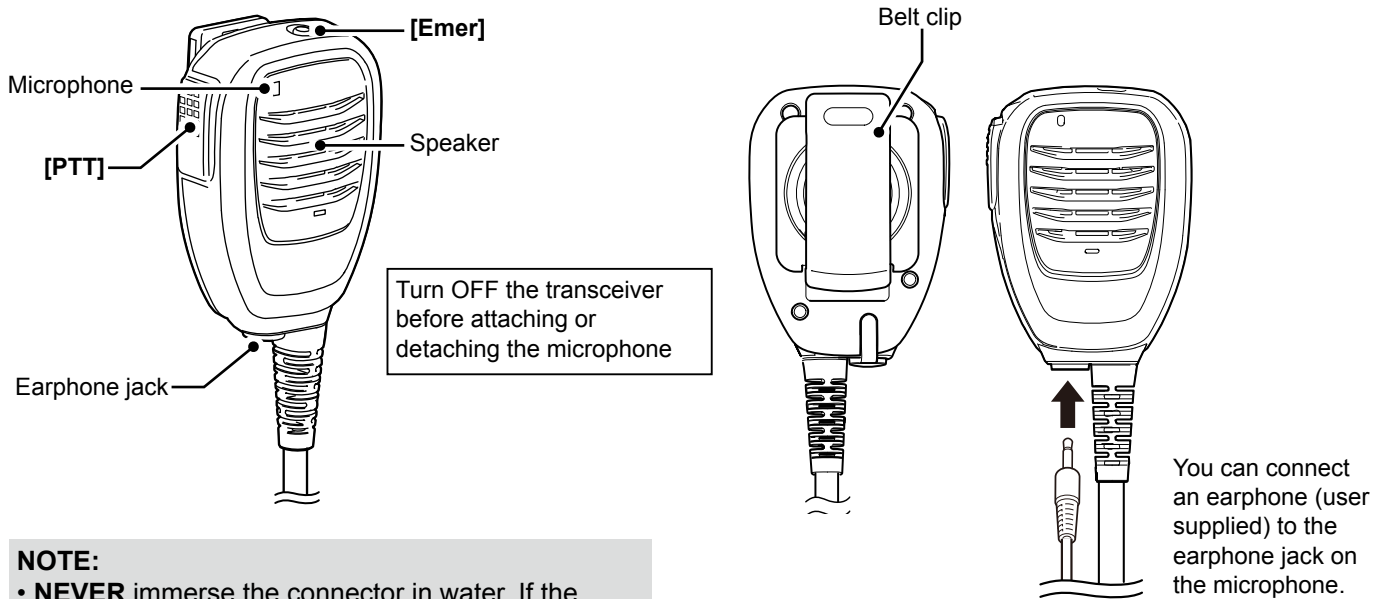

NOTE:

- **NEVER** immerse the connector in water. If the connector becomes wet, be sure to dry it **BEFORE** attaching to the transceiver.
- The microphone element is located at the top left of the speaker microphone, as shown in the illustration above. To maximize the readability of your transmitted audio, hold the microphone approximately 5 to 10 cm (2 to 4 inches) from your mouth, and then speak at your normal voice level.

◇ Attaching

Attach the connector of the speaker microphone to the multi connector on the transceiver and tighten the screw.

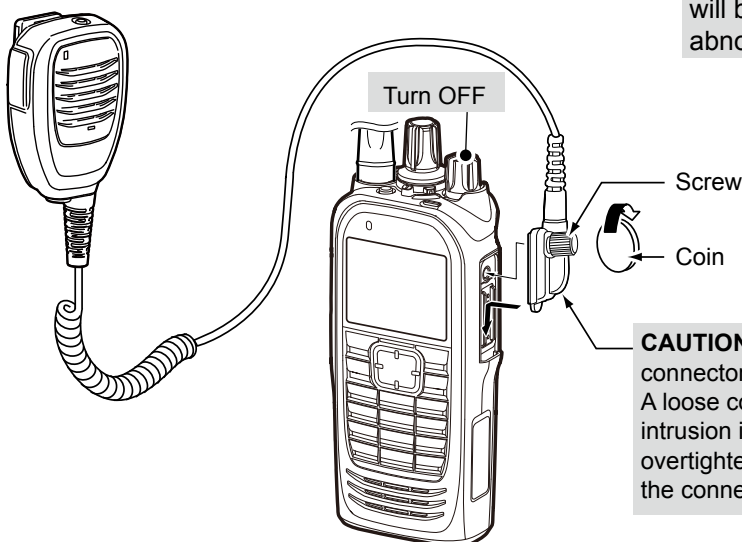

NOTE: KEEP the connector cover attached to the transceiver when the speaker microphone is not in use. Water will not get into the transceiver, even if the cover is not attached. However, the terminals (pins) will become rusty, or the transceiver will function abnormally if the connector becomes wet.

MB-136 BELT CLIP (for the Portable type transceiver)

◆ MB-136 contents

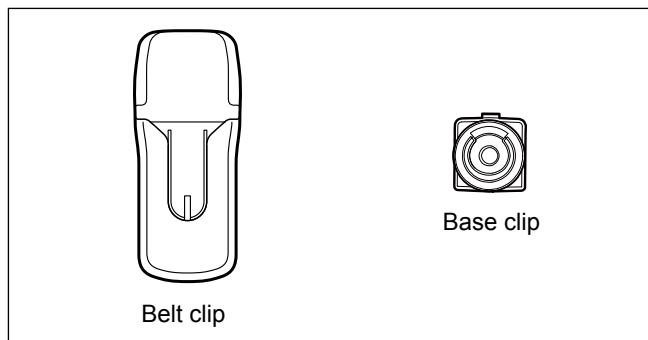

◆ Attaching

1. Detach the battery pack, if attached. (p. 1-3)
2. Slide the base clip in the direction of the arrow until the clip locks and makes a "click" sound.
3. Attach the battery pack to the transceiver. (p. 1-3)

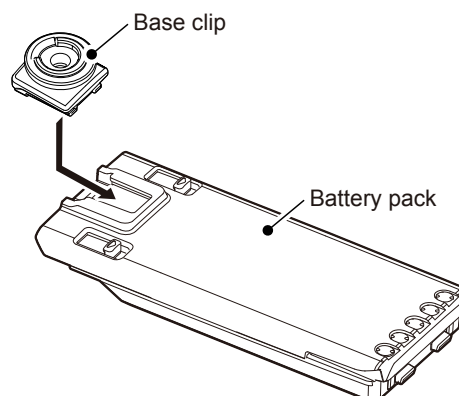

4. Clip the belt clip on your belt.
5. Insert the transceiver upsidedown into the belt clip until the base clip is fully inserted in the groove.

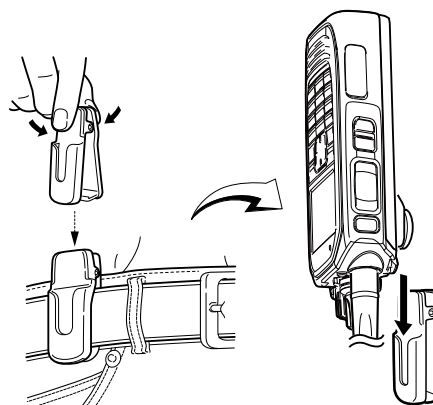

6. Once the transceiver is locked in place, it swivels, as shown to the right.

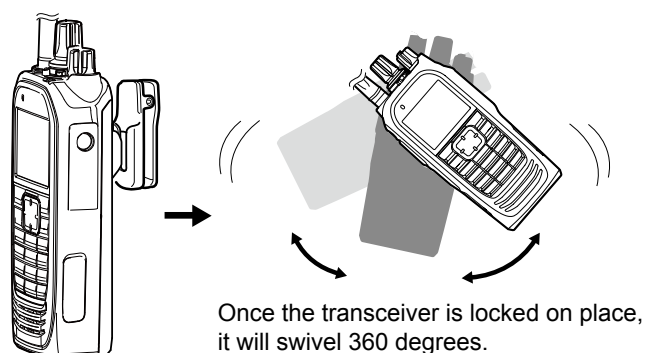

MB-136 BELT CLIP (for the Portable type transceiver)

◇ Detaching

1. Turn the transceiver upsidedown in the direction of the arrow and pull it out of the belt clip.
2. Detach the battery pack. (p. 1-3)

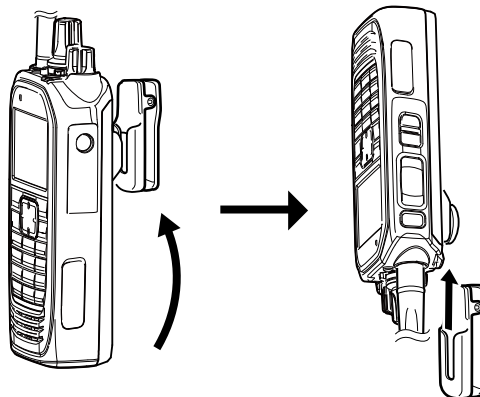

3. Pinch the tab on the base clip (1), and then slide the clip in the direction of the arrow (2).

BE CAREFUL! Don't break your fingernail.

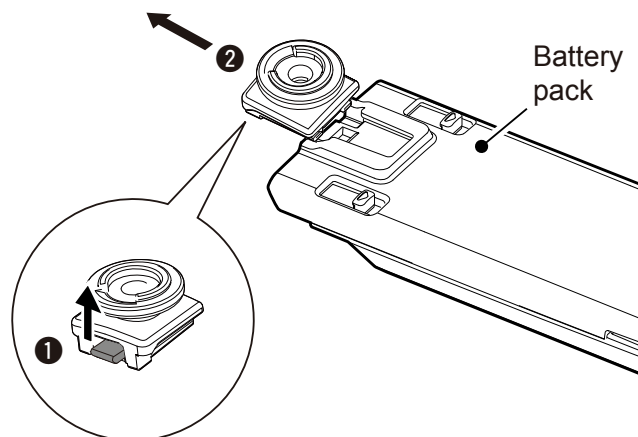

NOTE: HOLD THE TRANSCEIVER TIGHTLY WHEN INSERTING OR REMOVING THE TRANSCEIVER FROM THE BELT CLIP. Otherwise the transceiver may not be properly attached to the holder or swivel, if the transceiver has been accidentally dropped and the base clip is scratched or damaged.

LC-184/LC-186 CARRYING CASE (for the Portable type transceiver)

◆ Types

Select the LC-184 or LC-186 carrying case, according to the transceiver type.

- LC-184: For the Simple key types and Ten-key types.
- LC-186: For the Non-display types.

◆ Attaching

1. Insert the transceiver into the carrying case, as shown to the right.
2. Connect the hook and loop tape points.

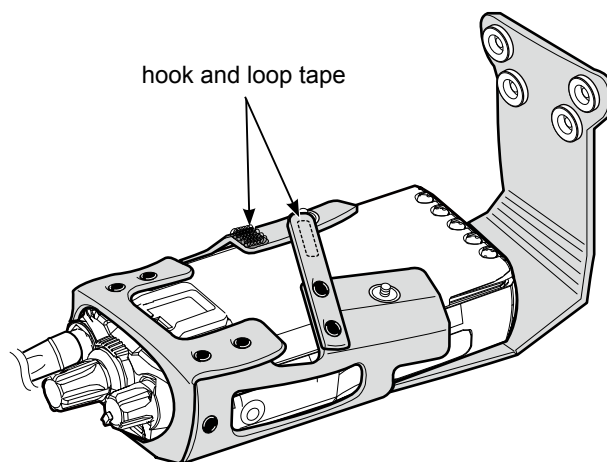

3. Adjust the snap buttons to secure the transceiver, as shown to the right.

- BP-283: Use the lower snap buttons to secure the transceiver.
- BP-284: Use the upper snap buttons to fasten the transceiver.

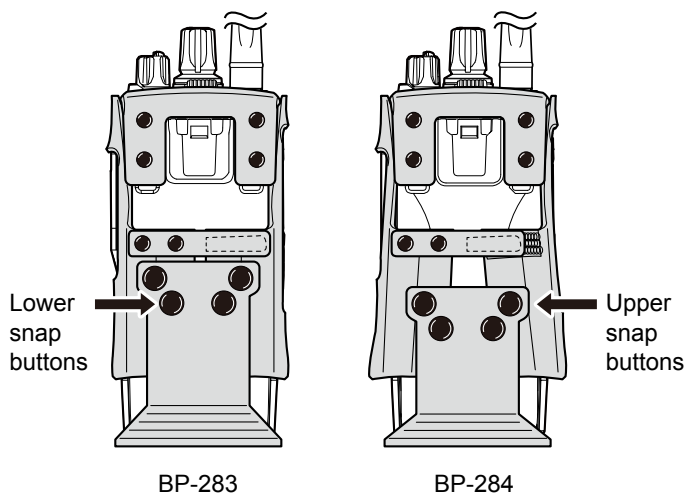

INDEX

A	
Accessories	
Attaching	1-3
Supplied	1-2
Antenna	1-3
AquaQuake Water Draining function (Portable)	4-8
Assignable keys, keypads, and Lever switch	2-11
Assignable Software key functions	2-13
For keys and keypads	2-13
For the Lever switch (Portable)	2-23
Audio level	
Adjusting	3-2
B	
Backlight status setting	13-2
Battery pack	1-3
Belt clip	1-4
BIIS 1200 system operation	9-2
Bluetooth	
Accepting a pairing request	12-11
Deleting from the pairing list	12-14
Disconnecting	12-13
Pairing with a data device	12-9
Pairing with a headset	12-6
Resetting the installed Bluetooth unit	12-15
Resetting the installed unit	
For the Mobile Segment types	12-16
For the Portable Non-display types	12-16
For the Portable Ten-key and Simple key types and Mobile LCD types	12-15
The maximum number of paired devices	12-17
Turning ON the function	
For the Mobile Segment types	12-5
For the Portable Non-display types	12-4
For the Portable Ten-key and Simple key types and Mobile LCD types	12-3
Bluetooth Wireless Technology operation	12-2
C	
Call procedure	3-7
Categories	6-2
Audio Setting	6-14
Bluetooth	6-16
Channel/Scan	6-8
Clock	6-17
Control Head	6-21
Display	6-18
Functions	6-10
GPS	6-12
Information	6-20
SD Card	6-15
Sensor	6-18
Signaling/Call	6-9
Trunking	6-10
Utility	6-19
Vibration	6-17
Voice Rec	6-13
Channel	
Selecting	3-4
Connector cover	1-5
Continuous tone channel	3-5
Copying data from a transceiver	14-4
D	
Deleting a file	11-8
DTMF	
Autodial	4-2
Hot DTMF	4-2
Manual Dialing	4-2
Stun function	4-2
DTMF calls	4-2
E	
Electromagnetic Interference	12-2
Emergency call	
Transmitting	4-3
[Emergency] key	4-3
The Lone Worker function	4-5
The Man Down function	4-4
The Motion Detection function	4-6
The Stationary Detection function	4-6
Encryption function	7-24
F	
Firmware information	14-2
Front, top and side panels (Mobile)	2-5
Front, top and side panels (Portable)	2-2
Function display (Mobile)	2-7
Function display (Portable)	2-3
H	
Headset settings	12-8
AF Output	12-8
Key Beep	12-8
One-touch PTT	12-8
Power Save	12-8
PTT Beep	12-8
HM-218 hand microphone (Mobile)	15-2
Connecting	15-2
Software key functions	15-2
Status indicator	15-2
HM-222 speaker microphone (Portable)	15-3
Attaching	15-3
I	
Icon	2-3,2-4,2-7,2-8
Incoming Call log function	8-22
Checking the Incoming call log	8-22
Incoming list	
Deleting	7-22,9-15
Displaying	7-20,9-14
K	
Key Lock function	3-10
Key-touch Beep level setting	13-3
L	
LC-184/LC-186 carrying case (Portable)	15-6
Attaching	15-6
Types	15-6
LCD Color Check	14-3

INDEX

M

MB-136 belt clip (Portable).....	15-4	RX Speaker.....	6-11
Attaching.....	15-4	Surveillance.....	6-11
Contents.....	15-4	USB Mode Select.....	6-11
Detaching.....	15-5	VOX.....	6-11
MDC 1200 system operation.....	8-2	VOX Delay.....	6-11
Menu items.....	6-3	VOX Gain.....	6-11
Audio Setting.....		Zeroize.....	6-11
Mic Gain.....	6-14	GPS.....	
RX Equalizer Effect.....	6-14	GPS ON/OFF.....	6-12
RX Noise Cancel.....	6-14	My Position.....	6-12
TX Equalizer Effect.....	6-14	RX List.....	6-12
Bluetooth.....		Information.....	
Bluetooth.....	6-16	Battery Info.....	6-20
Bluetooth Audio Setting.....	6-16	Comment.....	6-20
Bluetooth Auto Connect.....	6-16	Firmware Info.....	6-20
Bluetooth Reset.....	6-16	Own ID.....	6-20
BT Device Info.....	6-16	RSSI/VER/MER.....	6-20
BT Device List.....	6-16	SD Card.....	
Key Beep (VS-3).....	6-16	Load Setting <- SD.....	6-15
One-touch PTT.....	6-16	SD Format.....	6-15
P.Save (VS-3).....	6-16	SD Information.....	6-15
PTT Beep (VS-3).....	6-16	SD Unmount.....	6-15
Waiting Pairing.....	6-16	Software Update.....	6-15
Channel/Scan.....		Sensor.....	
Compander.....	6-8	Man down Angle.....	6-18
C.Tone CH Select.....	6-8	Motion Sense.....	6-18
Prio A (Rewrite).....	6-8	Stationary Sense.....	6-18
Priority A CH.....	6-8	Signaling/Call.....	
Priority B CH.....	6-8	Call List Select.....	6-9
RAN CH Select.....	6-8	Call Menu.....	6-9
RF Power.....	6-8	Clear Incoming.....	6-9
Scan List.....	6-8	Clear Outgoing.....	6-9
Scan Start/Stop.....	6-8	DTMF Autodial.....	6-9
Scan Tag.....	6-8	Group Select.....	6-9
Scramble/Encrypt.....	6-8	Incoming.....	6-9
Talk Around.....	6-8	Individual Select.....	6-9
Zone Select.....	6-8	Message.....	6-9
Clock.....		Outgoing.....	6-9
Clock Adjust.....	6-17	Status.....	6-9
Clock Auto Adjust.....	6-17	Write Message.....	6-9
Clock Display.....	6-17	Trunking.....	
DST.....	6-17	Roaming Request.....	6-10
Control Head.....		Site Lock.....	6-10
Hanger.....	6-21	Site Select.....	6-10
Head SP Out.....	6-21	Utility.....	
Intercom.....	6-21	Announce Lv.....	6-19
Primary Mic.....	6-21	Emer Beep Lv.....	6-19
SP Link.....	6-21	Key-touch Beep Lv.....	6-19
TX AF Monitor.....	6-21	Opening Beep Lv.....	6-19
Display.....		Ringer Lv.....	6-19
Backlight.....	6-18	Side Tone Lv.....	6-19
Brightness.....	6-18	SQL Level.....	6-19
Dimmer.....	6-18	System Beep Lv.....	6-19
LCD Color Test.....	6-18	Warning Beep Lv.....	6-19
LCD Mode.....	6-18	Vibration.....	
Functions.....		Key Vibration.....	6-17
Ext CH Sel Mode.....	6-10	Opening Vibration.....	6-17
Hook Scan.....	6-10	Vibration.....	6-17
Horn.....	6-10	Voice Rec.....	
Keypad.....	6-10	Call Recorder.....	6-13
Lone Worker.....	6-10	Play Call Rec.....	6-13
Public Address.....	6-10	Play Emer Call.....	6-13

INDEX

Menu screen	
Using.....	6-2
Menu screen description	6-2
Microphone connector.....	2-5
Microphone gain level setting.....	13-8
microSD card.....	10-2
Backing up.....	10-7
Displaying the information.....	10-6
Folder contents.....	10-7
Formatting.....	10-4
Inserting.....	10-3
Loading the saved data files.....	10-5
Making a backup file.....	10-9
Removing.....	10-3
Saving data.....	10-2
Unmounting.....	10-4
Mounting bracket.....	1-6
Multi-connector.....	2-2
Multi-site Conventional operation.....	7-2
Multi-site Trunking operation.....	7-2

N

NXDN Conventional operation.....	7-2
----------------------------------	-----

O

Opening screen image	
Changing.....	14-6
Operating channel.....	3-4
OTAP.....	7-25
Outgoing list	
Deleting.....	7-23
Displaying.....	7-21
Over The Air Programming function (OTAP).....	7-25

P

Password	
Entering.....	3-2
Player screen.....	11-7
Playing back	
Communication audio.....	11-5
Emergency audio.....	11-6
On a PC.....	11-9
Priority A or B channel	
Rewriting.....	3-5
Priority A or B channel	
Selecting.....	3-4

R

Radio Access Number (RAN).....	4-7
RAN channel.....	3-6
Rear panel (Mobile).....	2-6
Receiving.....	3-8
Receiving a call (BIIS).....	9-13
Emergency call.....	9-13
Group call.....	9-13
Individual call.....	9-13
Message.....	9-13
Status message.....	9-13
Receiving a call (MDC)	
MDC Call Alert call.....	8-19
MDC Emergency call.....	8-18
MDC Message call.....	8-21
MDC Selective Call (Sel Call).....	8-19
MDC Status call.....	8-21
MDC Stun call or Revive call.....	8-20

PTTID.....	8-18
Receiving a call (NXDN)	
Call Alert call.....	7-15
Emergency call.....	7-16
Group call.....	7-15
Individual call.....	7-15
Message.....	7-15
Radio Check call.....	7-15
Remote Monitor call.....	7-15
Status message.....	7-15
Stun, Kill or Revive.....	7-16
Recording	
Communication audio.....	11-2
Emergency audio.....	11-4
Ringer level setting.....	13-5
Roaming function (For the Multi-site Trunking operation).....	7-17
Roaming Request function.....	7-17
RX Noise Cancel level setting.....	13-14

S

Scan	
Canceling.....	5-3
Selecting a Scan list.....	5-4
Setting or clearing a Scan tag.....	5-5
Starting.....	5-2
Scrambler.....	4-7
Single-site Trunking operation.....	7-2
Site Lock function (For the Multi-site Trunking operation)	
.....	7-18
Site Select function (For the Multi-site Trunking operation)	
.....	7-19
Squelch level setting.....	13-7
Status indicator.....	2-9,2-10

INDEX

T

Transceiver types (Mobile)	2-5
Transceiver types (Portable)	2-2
Transmitting	3-8
Sending a call to a destination	3-9
Transmitting a call (BIS)	9-3
Directly entering message	9-11
Emergency call	9-12
Group call	9-5
Individual call	9-3
Message	9-9
Status message	9-7
Transmitting a call (MDC)	
MDC Call Alert call	8-6
MDC Emergency Acknowledgement	8-4
MDC Emergency call	8-4
MDC Message call	8-16
MDC Radio Check call	8-8
MDC Revive call	8-12
MDC Selective Call (Sel Call)	8-5
MDC Status call	8-14
MDC Stun call	8-10
PTT ID	8-3
Transmitting a call (NXDN)	
Call Alert call	7-10
Directly entering message	7-9
Emergency call	7-13
Group call	7-4
Individual call	7-3
Kill command	7-13
Message	7-7
Position data	7-14
Radio Check	7-11
Remote Monitor call	7-11
Revive command	7-12
Status message	7-5
Stun command	7-12
Transmitting notes	3-8
Turning ON the transceiver	3-2
TX Noise Cancel level setting	13-12

V

VOX Delay setting	13-10
VOX function setting	13-9
VOX gain level setting	13-11

Z

Zone	
Selecting	3-3

Count on us!

