



OPERATING GUIDE

VHF DIGITAL TRANSCEIVER

IC-F52D

UHF DIGITAL TRANSCEIVER

IC-F62D

INTRODUCTION

1 ACCESSORIES

2 PANEL DESCRIPTION

3 BASIC OPERATION

4 ADVANCED OPERATION

5 SCAN OPERATION

6 MENU SCREEN

7 dPMR™ OPERATION

8 BIIS 1200 SYSTEM OPERATION

9 VOICE RECORDER FUNCTIONS

10 Bluetooth® OPERATION

11 OTHERS

12 OPTIONS

INTRODUCTION

Thank you for choosing this Icom product. This product is designed and built with Icom's state of the art technology and craftsmanship. With proper care, this product should provide you with years of trouble-free operation.

IMPORTANT

FIRST, CAREFULLY READ PRECAUTIONS AND INSTRUCTIONS that are provided with the transceiver.

SAVE THIS OPERATING GUIDE— This operating guide contains additional important operating instructions for the following transceivers.

Icom, Icom Inc. and Icom logo are registered trademarks of Icom Incorporated (Japan) in Japan, the United States, the United Kingdom, Germany, France, Spain, Russia, Australia, New Zealand, and/or other countries.

AQUAQUAKE is a trademark of Icom Incorporated. dPMR and the dPMR logo are trademarks of the dPMR MoU Association.

The Bluetooth word mark and logos are registered trademarks owned by the Bluetooth SIG, Inc. and any use of such marks by Icom Inc. is under license. Other trademarks and trade names are those of their respective owners. All other products or brands are registered trademarks or trademarks of their respective holders.

Icom is not responsible for the destruction, damage to, or performance of any Icom or non-Icom equipment, if the malfunction is because of:

- Force majeure, including, but not limited to, fires, earthquakes, storms, floods, lightning, other natural disasters, disturbances, riots, war, or radioactive contamination.
- The use of Icom transceivers with any equipment that is not manufactured or approved by Icom.

Section 1 ACCESSORIES

Supplied accessories.....	1-2
Attaching accessories.....	1-3
◇ Flexible antenna	1-3
◇ Battery pack.....	1-3
◇ Belt clip	1-4
◇ Connector cover	1-5

Supplied accessories

The following accessories are supplied.

NOTE: Some accessories are not supplied, or the shape is different, depending on the transceiver version.

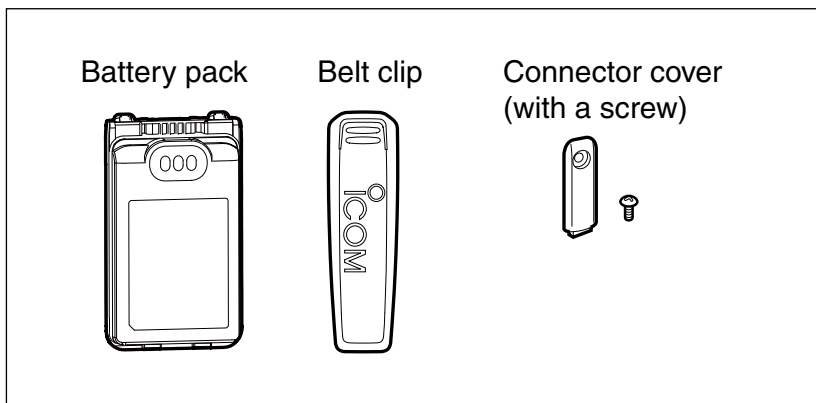

Attaching accessories

◇ Flexible antenna

Connect the required flexible antenna to the antenna connector.

CAUTION:

- **DO NOT** carry the transceiver by holding only the antenna.
- **DO NOT** connect an antenna other than those listed in the INSTRUCTIONS.
- Transmitting without an antenna may damage the transceiver.

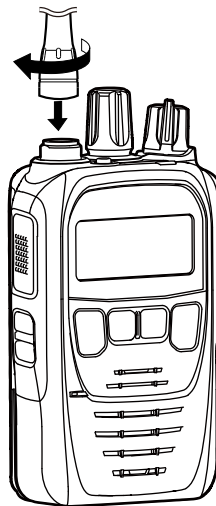

◇ Battery pack

CAUTION: DO NOT attach or detach the battery pack when the transceiver is wet or soiled. This may result in water or dust getting into the transceiver/battery pack and may damage the transceiver.

To attach:

1. Slide the battery pack in the direction of the arrow. **(1)**
2. Push the battery pack until the battery sliding locks make a 'click' sound. **(2)**

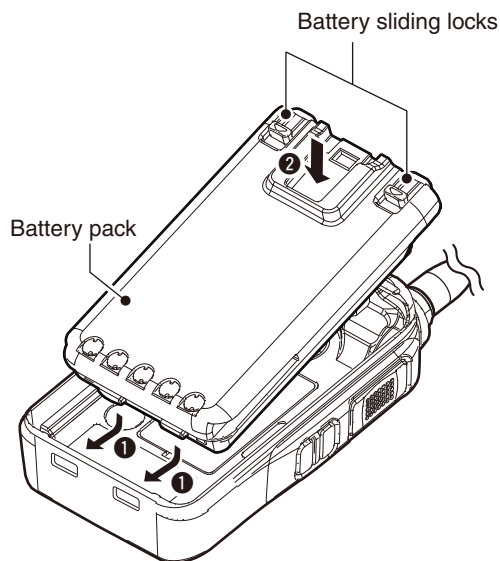

To detach:

1. Push both battery sliding locks in the direction of the arrow. **(1)**
 - The battery pack is then released.
2. Lift up to detach the battery pack. **(2)**

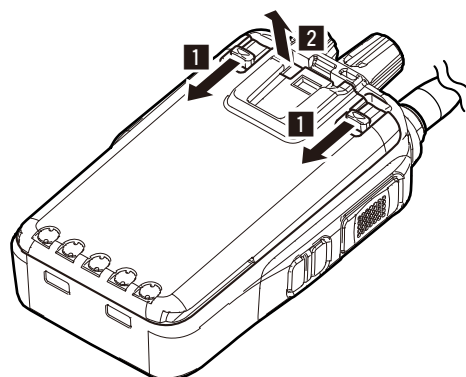

NOTE: Keep the battery pack terminals clean. It's a good idea to occasionally clean them.

1 ACCESSORIES

Attaching accessories

◇ Belt clip

To attach:

1. Remove the battery pack from the transceiver, if it is attached.
2. Slide the belt clip in the direction of the arrow until the belt clip is locked and makes a 'click' sound.

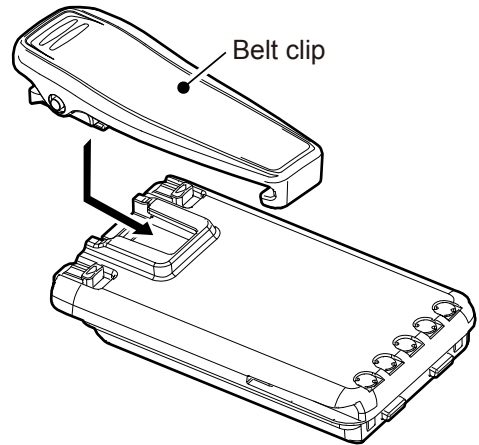

To detach:

Lift the tab up (①), and slide the belt clip in the direction of the arrow (②).

BE CAREFUL! DO NOT break your fingernail.

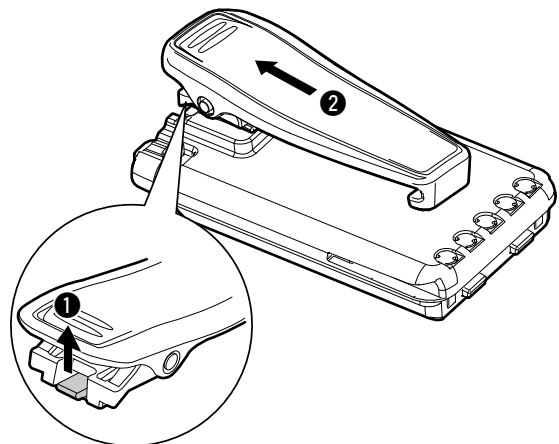

1 ACCESSORIES

Attaching accessories

◇ Connector cover

CAUTION: BE SURE to attach the connector cover when an optional device is not in use. Otherwise the terminals of the multi-connector may be shorted by a metal object, or become rusty by water intrusion. This could damage the transceiver.

To attach:

1. Attach the connector cover over the multi-connector. (1)
2. Tighten the screw. (2)

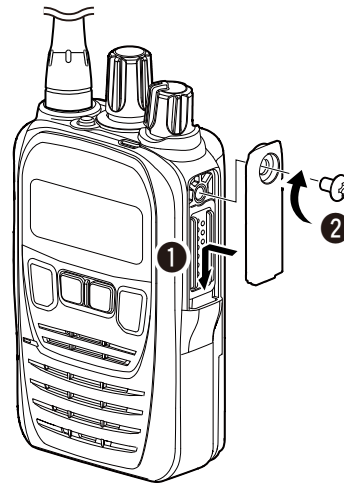

To detach:

1. Remove the screw. (1)
2. Detach the connector cover, and then connect an optional device. (2)

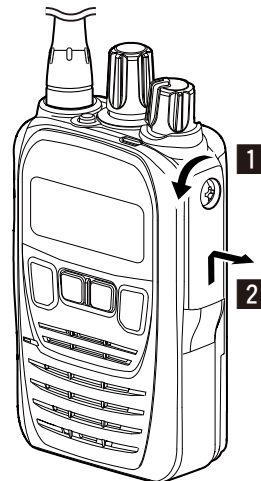

Section 2

PANEL DESCRIPTION

Front, top and side panels.....	2-2
◇ About the Status indicator.....	2-2
◇ About the Multi-connector.....	2-2
◇ About the Software key functions	2-2
Function display.....	2-3
◇ Icon Area.....	2-3
◇ Text Area.....	2-4
◇ Key Display Area	2-4
Status indicator.....	2-5
Assignable Software key functions.....	2-7

Front, top and side panels

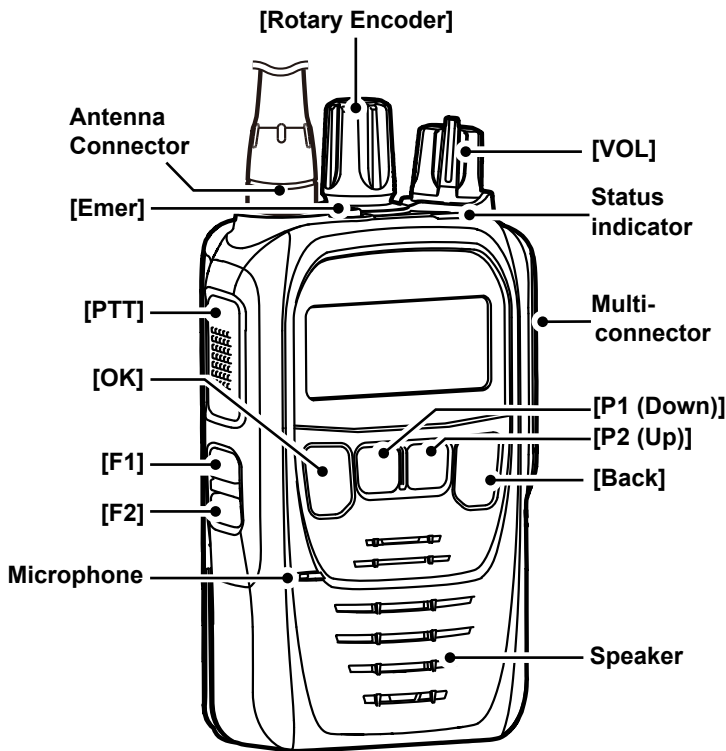

◇ About the Status indicator

- Lights white, then blinks red, yellow, and green when turning ON the transceiver.
- Lights red while transmitting.
- Lights green while receiving a signal, or when the squelch is open.

◇ About the Multi-connector

Connects to an optional speaker microphone or headset.

CAUTION: DO NOT use the transceiver without the connector cover or an optional device attached. The transceiver meets IP67 requirements for dust-tight and waterproof protection only when the connector cover or an optional device is attached.

◇ About the Software key functions

Dealers can assign the Software key functions to the following keys. See pages 2-7 ~ 2-13 for details.

[P1 (Down)], [P2 (Up)], [OK], [Back], [F1], [F2], and [Emer]

Function display

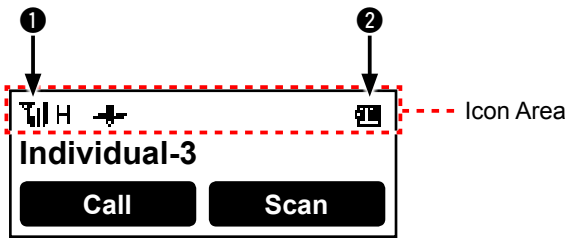

NOTE: The screen is an example. The displayed position of each icon may differ, depending on the function being used.

◇ Icon Area

Indicators

① SIGNAL STRENGTH INDICATOR

Displays the relative receive signal strength level.

② BATTERY INDICATOR

Displayed or blinks to indicate the battery status.

Indication				
Battery status	Full	Mid	Charging required	Battery exhausted

blinks when the battery is exhausted.

Icons

The following icons are displayed in the Icon Area.

SHIFT ICON

Displayed when the Shift function is ON.

① A user can use a Software key's secondary function in the Shift mode. Ask your dealer for details.

POWER ICON L1 L2 H

Displays the output power level.

- "L1" is displayed when the output power is set to Low.
- "L2" is displayed when the output power is set to Mid.
- "H" is displayed when the output power is set to High.

AUDIBLE ICON

Displayed when the channel is in the audible (unmuted) mode.

MESSAGE ICON

- Blinks after messages (Message or Status Message) have been received.
- Stops blinking when the screen is changed, or any key is pushed, but is displayed if unread messages are still in the Message memory.
- Disappears when all messages in the Message memory have been read.

BELL ICON

Displayed when a matching signal is received, depending on the presetting.

SCAN ICON

- Displayed when a scan is paused.
- Blinks while scanning.

SCAN TARGET CHANNEL ICON

Displayed when the channel is selected as a scan target channel.

SCRAMBLER ICON

In the Analog mode:

- Displayed when the Voice Scrambler function is ON.

In the Digital mode:

- Displayed when the Scrambler function is ON.
- Blinks while decoding an encrypted signal.

GPS ICON*

- Displayed when valid position data is received.
- Blinks while searching for satellites or calculating position data.

* The HM-233GP is required to use the GPS function.

RECORD ICON

- Displayed when the Record function is ON.
- Blinks while recording audio.

TALK AROUND ICON

Displayed when the Talk Around function is ON.

PHONE ICON

- Displayed when the transceiver is connected to a telephone network on the selected channel.
- Blinks while receiving a phone call.

SITE LOCK ICON

Displayed when the Site Lock function is ON.

LONE WORKER ICON

Displayed when the Lone Worker function is ON.

► Continued on the next page

2 PANEL DESCRIPTION

Function display

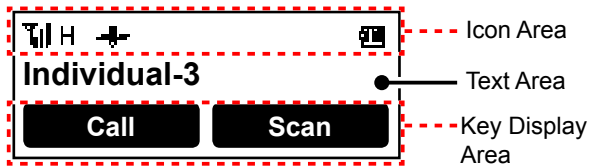

NOTE: The screen is an example.
The displayed position of each icon may differ,
depending on the function being used.

Icons (Continued)

MOTION SENSOR ICON

Displayed when the Motion Sensor function is ON.

NOISE CANCEL ICON

Displayed when the Noise Cancel function is ON.

SURVEILLANCE ICON

Displayed when the Surveillance function is ON.

VIBRATION ICON



Displayed when the Vibration function is ON.

VOX ICON*

Displayed when the VOX function is ON.

* VS-5MC, VS-3, or other Bluetooth headset is required to use the VOX function.

Bluetooth® ICON

- “” is displayed when Bluetooth is activated.
- “” is displayed when a Bluetooth device is connected.

BROADCAST CALL ICON

Displayed when a Broadcast call is received.

◇ **Text Area**

Displays the selected Zone number, channel number, and, if entered, the channel name.

◇ **Key Display Area**

Displays the names of the functions assigned to [P1] and [P2].

Status indicator

The Status indicator indicates the status of various parameters of the transceiver, as described below. (Reference: R=Red, G=Green, Y=Yellow, M=Magenta, W=White, B=Blue)

- Programming:
Blinks while reading or writing data.
 - Programming Error:
Blinks if cloning fails.
 - Channel Error:
Blinks when you select a blank channel, or an unlocked channel.
 - TX low Battery 1:
Blinks while detecting a low battery in the TX mode.
 - TX low Battery 2:
Blinks while detecting a very low battery in the TX mode.
 - TX:
Lights while transmitting.
 - Bell (Blink):
Blinks about twice every second.*
 - Bell (ON):
Blinks about once every second.*
- * Depending on the "Bell" setting, the Status indicator blinks:
- When a call that includes a matching 2-Tone code is received.
 - When a call that includes a matching 5-Tone code is received.
 - When a Message is received.
 - When a Status call that includes a matching status number is received.
- Scan, Hunt:
Blinks while scanning for a channel with a signal, or while hunting for a control channel.
 - RX:
Lights while receiving a signal.
 - CH Access:
Blinks while making a call.



2 PANEL DESCRIPTION

Status indicator

- Audible:
Blinks while in the Audible mode.
- Power ON:
Lights white, then blinks red, yellow, and green at transceiver startup.
- Success:
Blinks slowly when your call was successful.
- Failure:
Blinks slowly when your call failed, or it was refused.
- TX Error:
Blinks when transmission is inhibited (Lockout, TX Inh, or TOT Penalty timer).
- Emergency:
Blinks while the Emergency Locator tone is sounding.
- Searching (Bluetooth):
Blinks while searching for a Bluetooth device.
- Waiting Paring (Bluetooth):
Blinks while in the Waiting Pairing mode.
- Success (Bluetooth):
Blinks when the Bluetooth connection is successful.
- Failure (Bluetooth):
Blinks when the Bluetooth connection has failed.

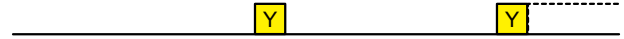

Assignable Software key functions

Category	Assignable function	Digital (dPMR)		Analog		
		Conventional	Trunking	2-Tone	5-Tone	BIIS
-	Disable (p. 2-9)	✓	✓	✓	✓	✓
	Null (p. 2-9)	✓	✓	✓	✓	✓
	Menu (p. 2-9)	✓	✓	✓	✓	✓
	Home (p. 2-9)	✓	✓	✓	✓	✓
	Shift (p. 2-9)	✓	✓	✓	✓	✓
Channel / Scan	CH Up, CH Down (p. 2-9)	✓	✓	✓	✓	✓
	Prio A, Prio B (p. 2-9)	✓	✓	✓	✓	✓
	Prio A (Rewrite), Prio B (Rewrite) (p. 2-9)	✓	✓	✓	✓	✓
	Zone Up, Zone Down (p. 2-9)	✓	✓	✓	✓	✓
	Zone Select (p. 2-9)	✓	✓	✓	✓	✓
	Scan Start/Stop (p. 2-9)	✓	✓	✓	✓	✓
	Scan Add/Del (Tag) (p. 2-10)	✓	✓	✓	✓	✓
	High/Low (p. 2-10)	✓	✓	✓	✓	✓
	C.Tone CH Select (p. 2-10)	N/A	N/A	✓	✓	✓
	Tone/CC CH Select (p. 2-10)	✓	✓	✓	✓	✓
	Monitor (p. 2-10)	✓	N/A	✓	✓	✓
	Talk Around (p. 2-10)	✓	✓	✓	✓	✓
	Bandwidth (p. 2-10)	N/A	N/A	✓	✓	✓
	Scrambler (p. 2-10)	✓	✓	✓	✓	✓
	Compander (p. 2-10)	N/A	N/A	✓	✓	✓
Signaling / Call	Call (p. 2-11)	✓	✓	✓	✓	✓
	Call A/Call B (p. 2-11)	✓	✓	✓	✓	✓
	Re-dial (p. 2-11)	✓	✓	✓	✓	✓
	Call List Select (p. 2-11)	✓	✓	✓	✓	✓
	Call Menu (p. 2-11)	✓	✓	✓	✓	✓
	DTMF Autodial (p. 2-11)	✓	✓	✓	✓	✓
	Emergency (p. 2-11)	✓	✓	✓	✓	✓
	Telephone (p. 2-11)	N/A	✓	N/A	N/A	N/A
	Individual (p. 2-11)	✓	✓	N/A	N/A	✓
	Group (p. 2-11)	✓	✓	N/A	N/A	✓
	Status (p. 2-11)	✓	✓	N/A	N/A	✓
	Message (p. 2-11)	✓	✓	N/A	N/A	✓
	Write Message (p. 2-11)	✓	✓	N/A	N/A	✓

✓: Applicable
N/A: Not Applicable

► Continued on the next page

2 PANEL DESCRIPTION

Assignable Software key functions

Category	Assignable function	Digital (dPMR)		Analog		
		Conventional	Trunking	2-Tone	5-Tone	BIIS
Trunking	Site Select (p. 2-12)	N/A	✓	N/A	N/A	N/A
	Site Lock (p. 2-12)	N/A	✓	N/A	N/A	N/A
	Roaming Request (p. 2-12)	N/A	✓	N/A	N/A	N/A
	Call Back (p. 2-12)	N/A	✓	N/A	N/A	N/A
Functions	Light (p. 2-12)	✓	✓	✓	✓	✓
	Lock (p. 2-12)	✓	✓	✓	✓	✓
	Sp. Func 1/2/3/4/5/6 (p. 2-12)	✓	✓	✓	✓	✓
	VOX (p. 2-12)	✓	✓	✓	✓	✓
	Lone Worker (p. 2-12)	✓	✓	✓	✓	✓
	Surveillance (p. 2-12)	✓	✓	✓	✓	✓
	AquaQuake (p. 2-12)	✓	✓	✓	✓	✓
GPS	GPS Position (p. 2-13)	✓	✓	✓	✓	✓
Voice Recording	Call Recorder (p. 2-13)	✓	✓	✓	✓	✓
	Last Call Play (p. 2-13)	✓	✓	✓	✓	✓
	Play Call Record (p. 2-13)	✓	✓	✓	✓	✓
Audio Setting	TX Noise Cancel (p. 2-13)	✓	✓	✓	✓	✓
	RX Noise Cancel (p. 2-13)	✓	✓	✓	✓	✓
Bluetooth	Bluetooth (p. 2-13)	✓	✓	✓	✓	✓
	Waiting Pairing (p. 2-13)	✓	✓	✓	✓	✓
Vibration	Vibration (p. 2-13)	✓	✓	✓	✓	✓
Display	Backlight (p. 2-13)	✓	✓	✓	✓	✓
	Contrast (p. 2-13)	✓	✓	✓	✓	✓

✓: Applicable

N/A: Not Applicable

Assignable Software key functions

Disable

Set to disable the key.

NOTE: This key function is assignable to only [Ext. Emer].

Null

No function.

Menu

Push to display the “Menu” screen.

- ① Depending on the presetting, you may be able to make various calls, select various functions and adjust the transceiver settings in the Menu screen.
- ① In the Menu screen, the key functions assigned using the CS-F52D PROGRAMMING SOFTWARE do not function.

Home

In the Analog mode

- Push to reset the destination station code to the default, if it has been manually changed.
- While in the Audible mode, push to return to the Inaudible mode and automatically send a reset code or Clear Down signal.

In the Digital mode

- While in the Audible mode, push to return to the Inaudible mode and automatically send a reset code or Clear Down signal.
- While in the Selection mode (Message, Status Message, and so on), hold down for 1 second to return to the Standby mode.
 - The transceiver resets the destination Unit ID, call type and Talk Back function to the default.

Shift

1. Push to enter the Shift mode.
 -  icon is displayed.
 - ① A user can use a Software key's secondary function in the Shift mode.
2. Push this key again to return to the Normal mode.

Category: Channel/Scan

CH Up, CH Down

- Push to select an operating channel.
- After pushing specific keys, push to select an option, setting, and so on.

Priority A, Priority B

Push to select the Priority A or Priority B channel.

Priority A (Rewrite), Priority B (Rewrite)

- Push to select the Priority A or Priority B channel.
- Hold down for 1 second to assign the operating channel to the Priority A or Priority B channel.

Zone Up, Zone Down

Push to select an operating zone.

Zone Select

1. Push to display the “Zone Select” screen.
2. Push [P1 (Down)] or [P2 (Up)] to select a Zone.

TIP: What is a “Zone”?

Certain channels are grouped together and assigned to a Zone according to their intended use. For example, ‘Staff A’ and ‘Staff B’ are assigned to a “Business” Zone, and ‘John’ and ‘Cindy’ are assigned to a “Private” Zone.

Scan Start/Stop

- Push to start or cancel a Scan.
 - ① When a scan started with the Power ON Scan or Auto Scan function, pushing this key pauses the scan. The paused scan resumes after the preset time period has passed.
- Hold down for 1 second to display the “Scan List” screen. Then push [P1 (Down)] or [P2 (Up)] to select a list.

NOTE: When Mode Dependent Scan is ON, a user may not be able to display the Scan list, depending on the presetting.

Assignable Software key functions

Category: Channel/Scan (Voting) (Continued)

Scan Add/Del (Tag)

- Push to add a channel to, or delete it from the current Scan list.
 - When a channel is added to the current Scan list, the current Scan list text and “ON” are briefly displayed.
 - When a channel is deleted from the current Scan list, the current Scan list text and “OFF” are briefly displayed.
- You can add a channel to, or delete it from a selected Scan list.
 1. Hold down for 1 second to display the “Scan Tag” screen.
 2. Push [P1 (Down)] or [P2 (Up)] to select a list.
 3. Push [OK] to add a channel to, or delete it from the selected list.
 - When a channel is added to the selected Scan list, the current Scan list text and “ON” are briefly displayed.
 - When a channel is deleted from the selected Scan list, the current Scan list text and “OFF” are briefly displayed.
 4. Push [Back] to exit the “Scan Tag” screen.
- While a scan is paused by detecting a signal on a channel (except for a primary or secondary channel), push this key to remove the channel from the Scan list.

TIP: When the Nuisance Delete function is ON, the removed channel is automatically added to the Scan list again, after the scan is canceled.

High/Low

Push to select the transmit output power level temporarily or permanently, depending on the presetting.

C.Tone CH Select

In the Analog mode

Push to display the “C.Tone CH Select” screen. Then push [P1 (Down)] or [P2 (Up)] to select a tone frequency or code. After selecting, push [OK] to save.

Tone/CC CH Select

In the Analog mode

1. Push to display the “C.Tone CH Select” screen.
2. Push [P1 (Down)] or [P2 (Up)] to select a tone frequency or code.
3. Push [OK] to save.

In the Digital mode (Conventional only)

1. Push to display the “CC CH Select” screen.
2. Push [P1 (Down)] or [P2 (Up)] to select a CC.
3. Push [OK] to save.

Monitor

- Push to turn the CTCSS (DTCS), 2-Tone, or 5-Tone squelch mute ON or OFF.
 - ① Only during 2-Tone mode operation, push to open any squelch, or deactivate any mute functions.
 - ① Only during 5-Tone mode operation, push to activate one or two of the following functions on each channel (Depending on the presetting):
 - Hold down to unmute the channel (Audible mode).
 - Push to mute the channel (Inaudible mode).
- NOTE:** The audible (unmuted) mode may automatically return to the Inaudible (muted) mode, after the preset period of time.
- Depending on the presetting, holding down this key for 1 second may cancel the Scan.

Talk Around

Push to turn the Talk Around function ON or OFF.

- ① The Talk Around function equalizes the transmit frequency to the receive frequency, for direct (Simplex) communication.

Bandwidth

In the Analog mode

Push to temporarily set the channel width to Wide* or Narrow.

- ① The wide passband width can be preset to either 25.0 kHz (Wide) or 20.0 kHz (Mid). Depending on the presetting, Mid channel width may be selectable.

* The Wide channel width cannot be used in the USA version transceivers.

Scrambler

In the Analog mode

Push to turn the Voice Scrambler function ON or OFF.

- ① The Voice Scrambler function provides private communication between stations by using a scrambled code.

In the Digital mode

Push to turn the Voice Scrambler function ON or OFF.

- ① The Voice or Data Scrambler function provides private communication between stations by using a Scrambler Key and Key ID.

Compander

In the Analog mode

Push to turn the Compander function ON or OFF.

- ① The Compander function reduces noise components on the transmit audio to provide clear communication.

Assignable Software key functions

Category: Signaling/Call

Call

In the Analog mode

Push to make a call to the preset destination in the channel.

Call A/Call B

In the Analog mode

Push to transmit a preset 2/5-Tone code or BIIS Call Setup to the preset destination.

In the Digital mode

Push to transmit a Call Setup to the preset destination.

Re-dial

Push to send the last transmitted DTMF code number.

- ① Redial will be cleared when the transceiver is turned OFF once.

Call List Select

1. Push to display the "Call List" screen.
2. Push [P1 (Down)] or [P2 (Up)] to select an ID name (or ID code).
3. After selecting, push [OK] to set, and return to the Standby mode.

Call Menu

1. Push to display the "Call Menu" screen.
2. Push [P1 (Down)] or [P2 (Up)] to select an ID name (or ID code).
3. After selecting, push [OK] to set, and display the call function screen.
4. Push [P1 (Down)] or [P2 (Up)] to select a call function.
 - ① See 'Transmitting a call' on Sections 7 and 8 for details.
5. After selecting, push [PTT] to make a call to the selected station or group.

DTMF Autodial

- Push to display the "DTMF Autodial" screen. Then, push [P1 (Down)] or [P2 (Up)] to select a DTMF code. After selecting, push [PTT] to transmit the selected DTMF code.
- While in the Standby mode, hold down for 1 second to transmit the currently selected DTMF code.

Emergency

1. Hold down during the Emer SW ON Timer period to enter the Emergency mode.
2. After the Reminder Timer period has passed, an Emergency call is automatically transmitted once, or repeatedly.

NOTE:

- Set the related settings using the programming software.
- This key function is assignable to only [Emer] or [Ext. Emer].

- ① Hold down during the Emer SW OFF Timer period to cancel the Emergency function, before transmitting an Emergency call.

Telephone

In the Digital mode (dPMR™ Trunking only)

1. Push to display the "Phone List" screen.
2. Push [P1 (Down)] or [P2 (Up)] to select a phone number.
3. Push [OK] to connect to the telephone network.

Individual

1. Push to display the "Individual ID" screen.
2. Push [P1 (Down)] or [P2 (Up)] to select an Individual ID name (or ID code).
3. Push [OK] to set.

Group

1. Push to display the "Group ID" screen.
2. Push [P1 (Down)] or [P2 (Up)] to select an Group ID name (or ID code).
3. Push [OK] to set.

Status

1. Push to display the "Status List" screen.
 2. Push [P1 (Down)] or [P2 (Up)] to select a Status message.
 3. Push [PTT] to send the message to the currently selected station or group, or push [OK] to set.
- ① See pages 7-5 and 8-4 for details.

Message

1. While in the Standby mode, push to display the "Message List" screen.
 2. Push [P1 (Down)] or [P2 (Up)] to select a message.
 3. Push [PTT] to send the message to the currently selected station or group.
- ① See pages 7-6 and 8-5 for details.

Write Message

1. Push to display the "Write Message" screen.
 2. Write a message.
 3. Push [PTT] to send the message to the currently selected station or group.
- ① See pages 7-7 and 8-6 for details.

Assignable Software key functions

Category: Trunking

Site Select

In the Digital mode (dPMR™ Trunking only)

1. Push to display the "Site Select" screen.
2. Push [P1 (Down)] or [P2 (Up)] to select a Site number.
3. Push [OK] to set the selected Site.
 - The selected site is locked.

Site Lock

In the Digital mode (dPMR™ Trunking only)

Push to turn the Site Lock function ON or OFF.

- ① When this function is turned ON, the transceiver cancels resuming a roaming scan, and stays on the current site, regardless of the error rate.

Roaming Request

In the Digital mode (dPMR™ Trunking only)

Push to execute the Roaming Request function.

- ① When this key is pushed, the transceiver starts or resumes a roaming scan, regardless of the error rate.
- ① When the Site Lock function is turned ON, pushing this key resumes a roaming scan.

Call Back

In the Digital mode (dPMR™ Trunking only)

Push to turn the Call Back function ON or OFF.

The Call Back function automatically sends back an acknowledgement (Call Back) to the caller station after receiving an Individual call.

Category: Functions

Light

Push to turn ON the backlight for about 5 seconds, even if the backlight setting is OFF.

Lock

Hold down for 1 second to turn the Key Lock function ON or OFF.

- ① All assignable keys except the following are electronically locked: [Monitor], [Light], [Lock], [Call], [Emergency], and [Surveillance]. Also, [PTT] and [Power] are usable.

Sp. Func 1, Sp. Func 2, Sp. Func 3, Sp. Func 4, Sp. Func 5, Sp. Func 6

Sp. Func 1 through Sp. Func 6 are reserved for PC commands.

VOX

Push to turn the VOX function ON or OFF.

- ① The function automatically switches between receive and transmit by detecting your voice.

NOTE:

- To use the function, a headset*¹ and a VOX converter cable are required (user supplied).
- When the VOX function is ON and using a third party Bluetooth headset, Synchronous Connection-Oriented (SCO) link*² is always connected.

*¹ Bluetooth headset is also usable.

*² A Bluetooth link for voice communication

Lone Worker

Push to turn the Lone Worker function ON or OFF.

- ① If no operation occurs during the set period of time, the Lone Worker function automatically makes the transceiver enter the Emergency mode.

NOTE: To use the Lone Worker function, set the related settings using the programming software.

Surveillance

Push to turn the Surveillance function ON or OFF.

When this function is turned ON, Beeps are not heard and the backlight and the Status indicator do not light, even when a signal is received, or a key is pushed.

AquaQuake™

While holding down this key, the AquaQuake water draining function removes water from the speaker grill by vibrating the internal speaker cone.

- ① Water in the speaker grill may muffle the sound coming from the speaker.

NOTE:

- After the set period of time, this function automatically stops, even if a user continues to hold down this key.
- This key works with only the internal speaker.

Assignable Software key functions

Category: GPS

GPS Position

Push to display the “GPS Position” screen in the Menu mode.

Category: Voice Recording

Call Recorder

Push to turn the Voice Recording function ON or OFF.

Last Call Play

Push to playback the last recorded audio file.

Play Call Record

Push to display the “Play Call Rec” screen.

① See page 9-3 for details.

Category: Audio Setting

TX Noise Cancel

Push to select the TX Noise Cancel level between 1 and 3 to suppress the microphone input noise to make the audio easy to hear.

① When “OFF” is selected, the microphone input noise is not suppressed.

RX Noise Cancel

Push to select the RX Noise Cancel level between 1 and 3 to suppress the receive audio noise to make the audio easy to hear.

① When “OFF” is selected, the receive audio noise is not suppressed.

Category: Bluetooth

Bluetooth

Push to turn the Bluetooth function ON or OFF.

Waiting Pairing

Push to enter the Pairing Request Wait mode.

- The transceiver waits for a pairing request from a Bluetooth device.

Category: Vibration

Vibration

Push to turn the Vibration function ON or OFF.

- ① When “ON” is selected, the transceiver vibrates when a matching call or ID is received.

Category: Display

Backlight

Push to select the Backlight level.

- **OFF**: The backlight is always OFF.
- **ON**: The backlight is always ON.
- **Auto**: When any switch except [PTT] is pushed, the backlight lights for 5 seconds.

Contrast

1. Push to open the “Contrast” window.
2. Push [P1 (Down)] or [P2 (Up)] to select the LCD contrast level between 0 (the lowest) and 50 (the highest).

Section 3

BASIC OPERATION

Turning ON the transceiver	3-2
◇ Turning ON the transceiver	3-2
◇ Adjusting the audio level	3-2
◇ Entering the password	3-2
Selecting a Zone.....	3-3
◇ Selecting a Zone	3-3
Selecting a channel	3-4
◇ Selecting an operating channel	3-4
◇ Selecting the Priority A or B channel.....	3-4
◇ Rewriting the Priority A or B channel	3-5
◇ Selecting a Continuous tone channel	3-5
◇ Selecting a CC channel	3-6
Call procedure	3-7
Receiving and transmitting	3-8
◇ Transmitting notes	3-8
◇ Sending a call to a destination	3-9
Key Lock function	3-10

Turning ON the transceiver

◇ Turning ON the transceiver

NOTE: Before using the transceiver for the first time, the battery pack must be fully charged for optimum life and operation. See the INSTRUCTIONS supplied with the transceiver for details.

Rotate [VOL] to turn ON the transceiver.

- The battery voltage or the opening text may be displayed, depending on the presetting.

◇ Adjusting the audio level

When receiving a call, rotate [VOL] to adjust the audio output level.

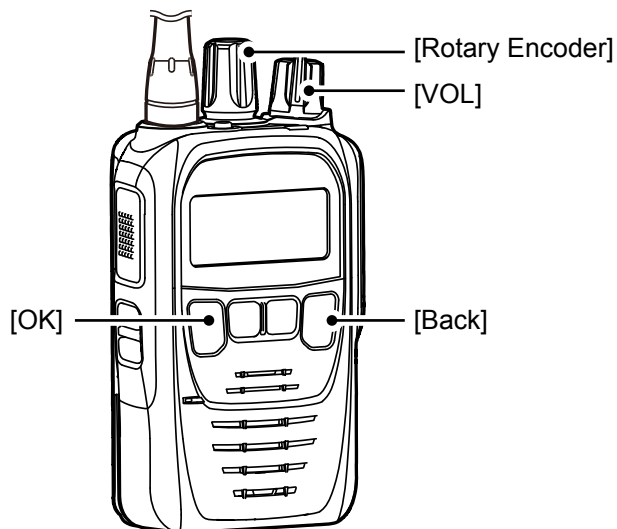

◇ Entering the password

1. If the transceiver is preset for a Power ON password when turning ON the transceiver, the "User Password" screen is displayed, as shown to the right.
2. Rotate [Rotary Encoder] to select a number, then push [OK] to enter.
3. After entering the correct password, the transceiver automatically displays the standby screen.

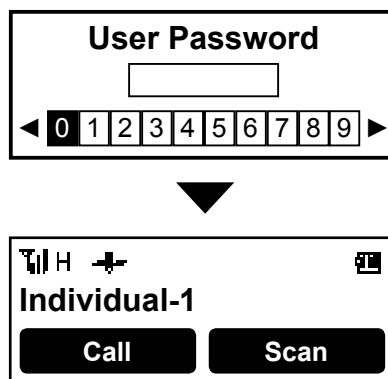

Standby screen

NOTE: If the transceiver does not display the standby screen after entering the password, the entered code may be incorrect. In this case, push [Back] several times until you delete the incorrect code, and then enter the correct code.

Selecting a Zone

◇ Selecting a Zone

Select a Zone type as shown:
Conventional, Trunking, or Voting

TIP: What is a “Zone”?

Certain channels are grouped together and assigned to a Zone according to their intended use. For example, ‘Staff A’ and ‘Staff B’ are assigned to a “Business” Zone, and ‘John’ and ‘Cindy’ are assigned to a “Private” Zone.

<Key or Rotary Encoder operation>

- Rotate [Rotary Encoder]*.
- Push [Zone Up] or [Zone Down].
- Push [Zone Select] to display the “Zone Select” screen. Then, push [P2 (Up)] or [P1 (Down)] to select a Zone. After selecting, push [OK].

*When “Zone” is assigned.

<Menu operation>

(Menu > Channel/Scan > Zone Select)

1. Push [Menu] to display the Menu screen.
2. Push [P2 (Up)] or [P1 (Down)] to select “Channel/Scan,” then push [OK].

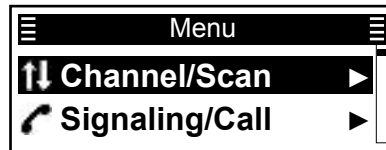

3. Push [P2 (Up)] or [P1 (Down)] to select “Zone Select,” then push [OK].



4. Push [P2 (Up)] or [P1 (Down)] to select a Zone, then push [OK].

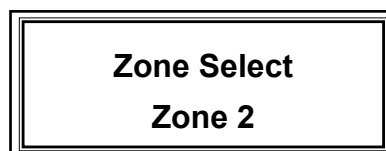
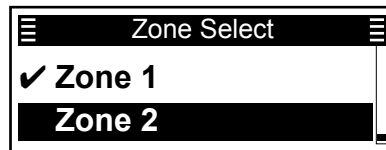

- “Zone Select (Zone ID)” is briefly displayed and is selected as an operating channel.

5. Hold down [Back] for 1 second to return to the Standby screen.

Selecting a channel

◇ Selecting an operating channel

<Key or Rotary Encoder operation>

- Rotate [Rotary Encoder].
- Push [CH Up] or [CH Down].

<Voting operation>

The transceiver automatically starts scanning when a Zone specified for the Voting operation is selected. The Voting scan detects the signal strength of the repeaters, and automatically selects the strongest one.

<Automatic Scan operation>

Depending on the presetting, when the user turns ON the transceiver, a scan automatically starts. The scan stops when a call is received.

◇ Selecting the Priority A or B channel

<Key operation>

Push [Prio-A] or [Prio-B] to select the Priority A or Priority B channel.

<Menu operation>

(Menu > Channel/Scan > **Priority A CH**)

(Menu > Channel/Scan > **Priority B CH**)

1. Push [Menu] to display the "Menu" screen.
2. Push [P2 (Up)] or [P1 (Down)] to select "Channel/Scan," then push [OK].

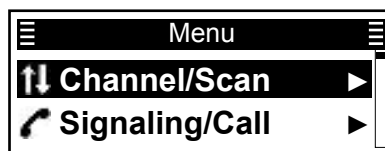

3. Push [P2 (Up)] or [P1 (Down)] to select "Priority A CH" or "Priority B CH," then push [OK].

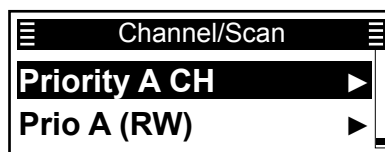

4. After a dialog is displayed, as shown below, push [P2 (Up)] or [P1 (Down)] to select <OK> on the dialog and push [OK].

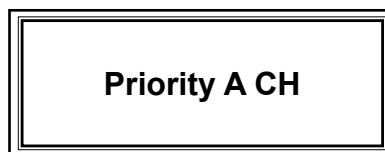

- "Priority A CH" is briefly displayed and is selected as an operating channel.

5. Hold down [Back] for 1 second to return to the standby screen.

Selecting a channel

◇ **Rewriting the Priority A or B channel**

(Menu > Channel/Scan > **Prio A (RW)**)

(Menu > Channel/Scan > **Prio B (RW)**)

1. Select a channel to be set as the Priority A or B channel. (p. 3-4)
2. Push [Menu] to display the “Menu” screen.
3. Push [P2 (Up)] or [P1 (Down)] to select “Channel/Scan,” then push [OK].

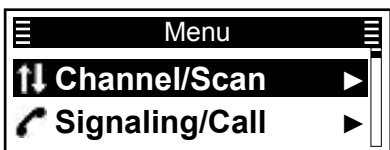

4. Push [P2 (Up)] or [P1 (Down)] to select “Prio A (RW)” or “Prio B (RW)” and push [OK].

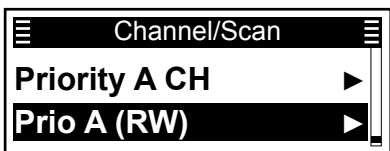

5. After a dialog is displayed, as shown below, push [P2 (Up)] or [P1 (Down)] to select <OK> on the dialog, then push [OK].



- “Prio A (RW)” is briefly displayed.
- Sets the selected channel as the Priority A or B channel.

6. Hold down [Back] for 1 second to return to the standby screen.

TIP: Hold down [Prio A (Rewrite)] or [Prio B (Rewrite)] for 1 second to set the currently selected channel as the Priority A or B channel.

◇ **Selecting a Continuous tone channel**

(Menu > Channel/Scan > **C.Tone CH Sel**)

1. While in the Analog mode, push [Menu] to display the “Menu” screen.
2. Push [P2 (Up)] or [P1 (Down)] to select “Channel/Scan,” then push [OK].

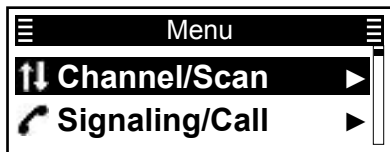

3. Push [P2 (Up)] or [P1 (Down)] to select “C.Tone CH Sel,” then push [OK].



4. Push [P2 (Up)] or [P1 (Down)] to select a Continuous tone channel, then push [OK].

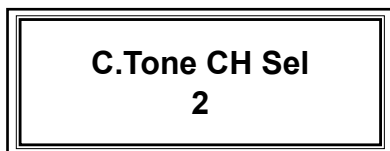
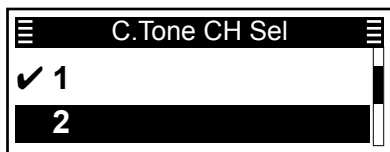

- The selected Continuous tone channel is briefly displayed and set.

5. Hold down [Back] for 1 second to return to the standby screen.

TIP: While in the Analog mode, push [C.Tone CH Select] to directly display the “C.Tone CH Sel” screen in step 4 above.

Selecting a channel

◇ **Selecting a CC channel**

(Menu > Channel/Scan > **CC CH Select**)

1. While in the Digital mode, push [Menu] to display the “Menu” screen.
2. Push [P2 (Up)] or [P1 (Down)] to select “Channel/Scan,” then push [OK].

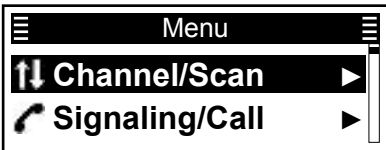

3. Push [P2 (Up)] or [P1 (Down)] to select “CC CH Sel,” then push [OK].

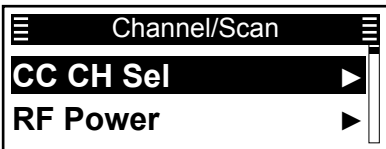

4. Push [P2 (Up)] or [P1 (Down)] to select a CC channel, then push [OK].

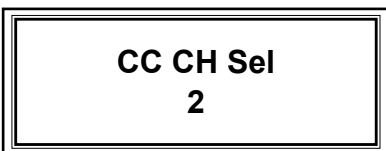
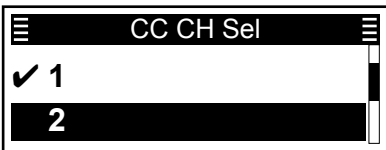

• The selected CC channel is briefly displayed and set.

5. Hold down [Back] for 1 second to return to the standby screen.

TIP: While in the Digital mode, push [Tone/CC CH Select] to directly display the “CC CH Sel” screen in step 4 above.

Call procedure

When your system uses tone signaling (except CTCSS and DTCS), a call procedure may be necessary prior to voice transmission. The tone signaling employed may be a selective calling system, which enables you to call only specific stations, and prevents unwanted stations from contacting you.

1. Select a channel according to your system operator's instructions.
 - ① This may not be necessary, depending on the presetting.
 - ① See page 3-4 for details.
2. Push [Call].
3. After transmitting, the remainder of your communication can be carried out in the normal way.

Selective calling

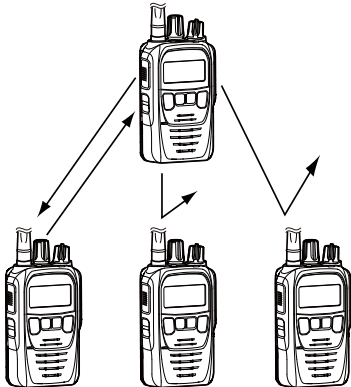

Non-selective calling

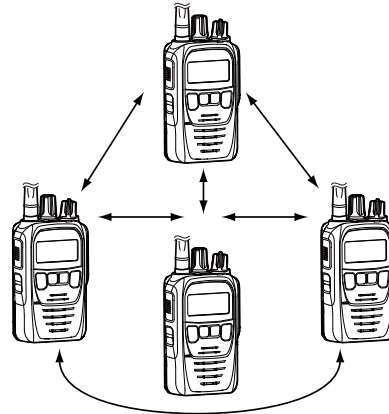

Receiving and transmitting

CAUTION: DO NOT transmit without an antenna. It may damage the transceiver. See pages 1-3 for accessory attachments.

Receiving:

1. Turn ON the transceiver. (p. 3-2)
2. Select a channel. (p. 3-4)
3. When receiving a call, rotate [VOL] to adjust the audio output level to a comfortable listening level.

NOTE: Depending on the presetting, the transceiver may automatically transmit the microphone audio for the preset time period when a matching signal is received. (Auto TX function)

Transmitting:

1. Wait for the channel to become clear to avoid interference.
2. While holding down [PTT], speak at your normal voice level.
① When a tone signaling system is used, the call procedure described on page 3-9 may be necessary.
3. Release [PTT] to return to receive.

IMPORTANT: To maximize the readability of your signal.

1. Pause briefly after pushing [PTT].
2. Hold the microphone 5 to 10 cm (2 to 4 inches) from your mouth, then speak at your normal voice level.

◇ Transmitting notes

Transmit inhibit function

The transceiver has several inhibit functions that restrict transmission under the following conditions:

- The channel is in the Inaudible mode (“”: Audible icon is not displayed.)
- The channel is busy. However, depending on the presetting, you can transmit when a call is received that includes a non-matching (or matching) CTCSS (DTCS), CC (Channel Code), Individual ID, or Group ID.
- The selected channel is a ‘receive only’ channel.

Time-Out Timer

If continuous transmission exceeds the preset Time-Out Timer time, the transmission is cut off.

Penalty timer

After the transmission is cut off by the Time-Out Timer, transmission is further inhibited for a preset penalty period of time.

Receiving and transmitting

◇ **Sending a call to a destination**

When a tone frequency (2-Tone) or code (5-Tone) is preset in the Call List, a user can select it as a destination.

(Menu > Signaling/Call > **Call List Select**)

1. Push [Menu] to display the Menu screen.
2. Push [P2 (Up)] or [P1 (Down)] to select "Signaling/Call," then push [OK].

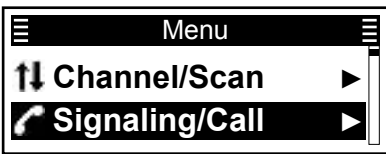

3. Push [P2 (Up)] or [P1 (Down)] to select "Call List Select," then push [OK].



4. Push [P2 (Up)] or [P1 (Down)] to select a destination, then push [OK].



• The selected destination is briefly displayed and set.

5. Hold down [Back] for 1 second to return to the standby screen.

Key Lock function

You can use the Key Lock function to prevent accidental channel changes and unnecessary function access.

- ① All assignable keys except the following are electronically locked: [Monitor], [Light], [Lock], [Call], [Emergency], and [Surveillance]. Also, [PTT] and [Power] are usable.

Hold down [Lock] for 1 second to turn the Key Lock function ON or OFF.



- "Lock ON" is displayed when the Key Lock function is ON.



- "Lock OFF" is displayed when the Key Lock function is OFF.

Section 4 **ADVANCED OPERATION**

DTMF calls	4-2
◇ Autodial	4-2
Emergency call	4-3
◇ Transmitting an Emergency call.....	4-3
Scrambler	4-7
CC channel signaling.....	4-7
AquaQuake™ Water Draining function	4-8

DTMF calls

◇ Autodial

A user can quickly send DTMF tones that have been pre-entered into the transceiver.

(Menu > Signaling/Call > **DTMF Autodial**)

1. Push [Menu] to display the Menu screen.
2. Push [P2 (Up)] or [P1 (Down)] to select “Signaling/Call,” then push [OK].

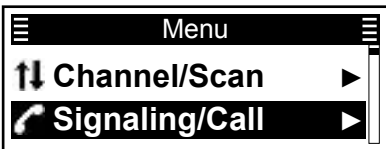

3. Push [P2 (Up)] or [P1 (Down)] to select “DTMF Autodial,” then push [OK].

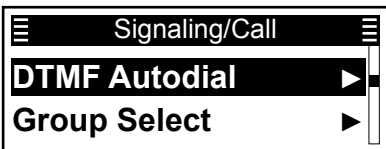

4. Push [P2 (Up)] or [P1 (Down)] to select a DTMF Memory, then push [PTT] to send the codes.

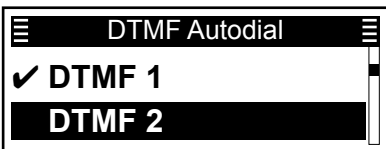

- After sending, automatically returns to the standby screen.

TIP: In the standby screen, a user can send the currently selected DTMF Memory’s codes by holding down [DTMF Autodial]. In the DTMF Autodial screen, a check mark is displayed by the currently selected codes.

Emergency call

IMPORTANT: It is recommended that the dealer sets an Emergency channel in each Zone, to provide a reliable Emergency call operation.

NOTE: Depending on the presetting, the following functions may be automatically activated.

Auto TX function

After an Emergency call transmission, the transceiver transmits the microphone audio for a preset period of time.

Auto RX function

After an Emergency call transmission, the transceiver stands by in the Audible mode for a preset period of time.

TIP: A user can transmit the Emergency call in the 2-Tone, 5-Tone, dPMR™, or BIIS signaling system.

◇ Transmitting an Emergency call

When the transceiver enters the Emergency mode, a countdown starts. The transceiver counts down during the Reminder Timer set time.

Before the Reminder Timer set time expires, the transceiver transmits an Emergency call once, or repeatedly*, on the specified Emergency channel. If no Emergency channel is specified, the Emergency call is made on the previously selected channel.

* Depending on the presetting.

- ① The transceiver automatically transmits a repeat Emergency call until it receives an acknowledgement, or until a user turns OFF the transceiver.
- ① If the transceiver is set for Silent operation, it transmits an Emergency call without a beep sounding or the status indicator lighting.

The transceiver enters the Emergency mode through the following functions:

• **The [Emergency] key**

When a user holds down [Emergency] for the Emer SW ON Timer preset time.

- ① If a user holds down [Emergency] for the Emer SW OFF Timer set time before the Reminder Timer expires, the Emergency mode is canceled.

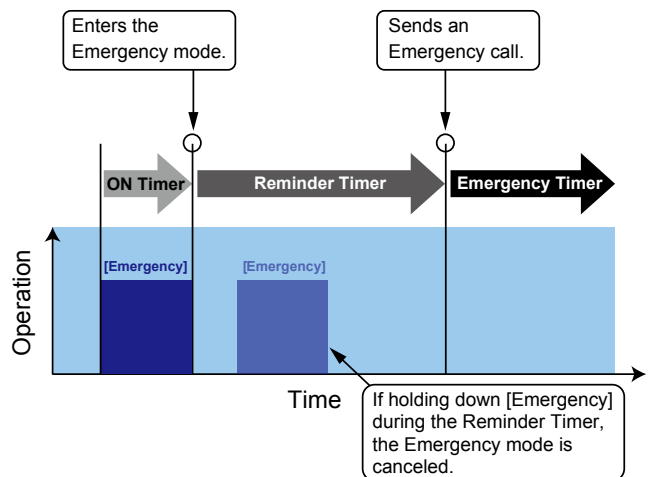

► Continued on the next page

Emergency call

◇ Transmitting an Emergency call (Continued)
 The transceiver enters the Emergency mode through the following functions:

• **The Man Down function**

When the transceiver leans past the preset angle for the ON Timer preset time.

- ① If a user raises the transceiver back from the preset angle towards the vertical position before the Reminder Timer set time expires, the Emergency mode is canceled.

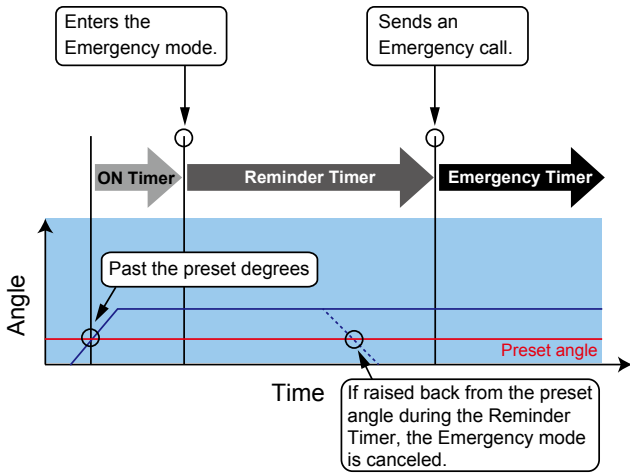

Man Down With Stationary

- The transceiver leans past the preset angle for the ON Timer preset time.
 AND
- The transceiver is detected as stationary (no motion) for the ON Timer set time.

- ① If a user raises the transceiver back from the preset angle towards the vertical position, or when the user moves the transceiver before the Reminder Timer set time expires, the Emergency mode is canceled.

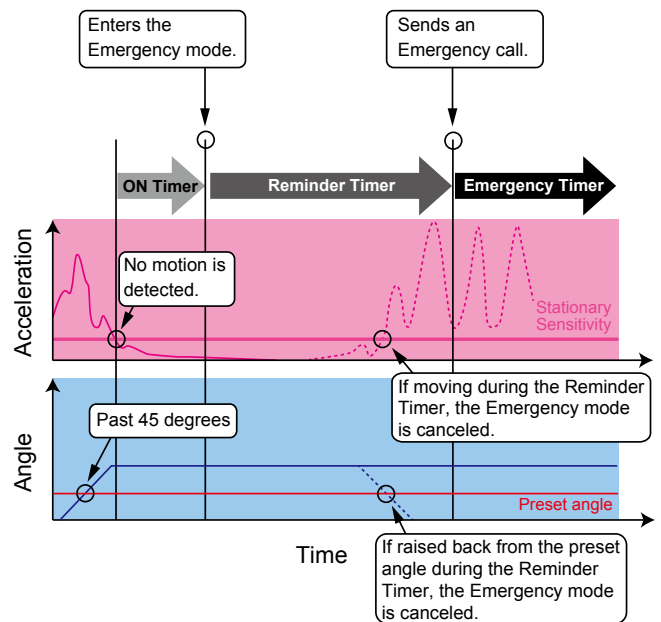

Emergency call

◇ Transmitting an Emergency call (Continued)
 The transceiver enters the Emergency mode through the following functions:

• **The Lone Worker function**

When no operation occurs for the ON Timer preset time.

- ① If a user pushes any key before the Reminder Timer set time expires, the Emergency mode is canceled.

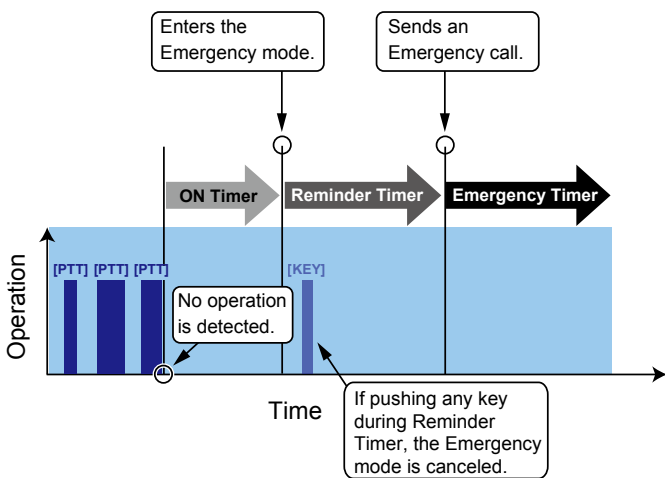

Lone Worker With Stationary

- When no operation occurs for the ON Timer preset time.
 AND
- The transceiver is detected as stationary (no motion) for the ON Timer set time.

- ① If a user pushes any key, or moves the transceiver before the Reminder Timer set time expires, the Emergency mode is canceled.

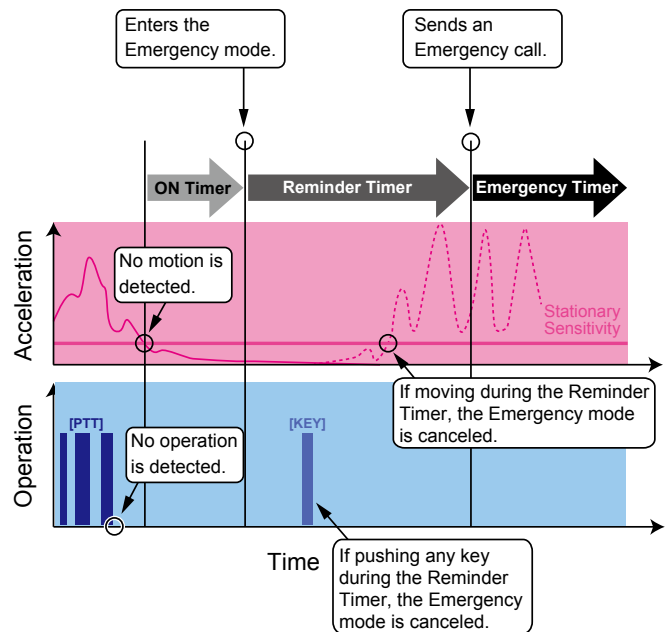

Emergency call

◇ Transmitting an Emergency call (Continued)
 The transceiver enters the Emergency mode through the following functions:

• **The Stationary Detection function**

When the transceiver is detected as being stationary (no motion) for the ON Timer preset time.

- ① If a user moves the transceiver during the Reminder Timer set time, the Emergency mode is canceled.

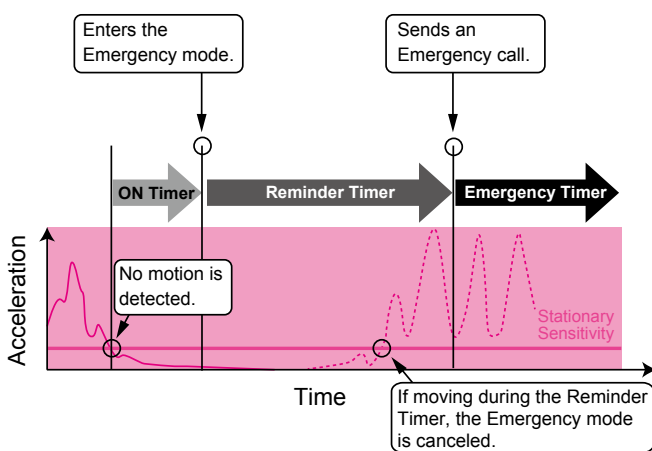

• **The Motion Detection function**

When the transceiver continuously moves for the ON Timer preset time.

- ① If a user holds down [Emergency] for the Emer SW OFF Timer set time, before the Reminder Timer set time expires, the Emergency mode is canceled.

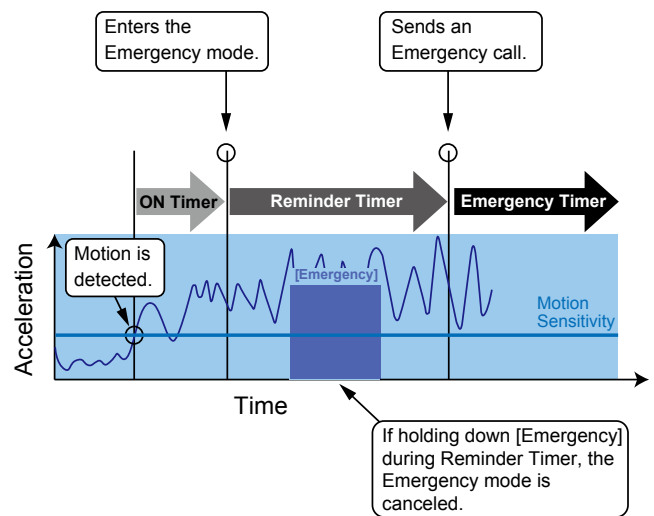

Scrambler

The Voice Scrambler function provides private communication between stations.

Push [Scrambler/Encryption] to toggle the Scrambler function ON or OFF.

- “” is displayed when the Scrambler function is ON.
- ① When the Scrambler function is ON, push [PTT] to make a private communication between stations by using a scrambled code.

CC channel signaling

CC is a signaling system designed for digital radio communications. When a channel is set up with a CC, the squelch will open only when a call including a matching CC is received. If a call including a different CC is made on the same channel a user is using, a user will not hear the call.

AquaQuake™ Water Draining function

By vibrating the speaker cone, the AquaQuake Water Draining function clears water from the speaker grill to maintain clear audio.

1. Hold down [AquaQuake] to turn ON the AquaQuake water draining function.
 - A low frequency vibration is generating to remove water from the speaker grill.
 - Water in the speaker grill may muffle the sound coming from the speaker.
2. Release the key to turn OFF the function.

NOTE:

- After the set period of time expires, this function automatically stops, even if a user continues to hold down this key.
- This key works for only the internal speaker.

Section 5 SCAN OPERATION

Starting a Scan	5-2
Canceling a Scan	5-3
Selecting a Scan list	5-4
Setting or clearing a Scan tag	5-5

Starting a Scan

A Scan checks for signals on each channel and stops when a signal is received.

NOTE: Two or more channels must be preset to start a Scan.

(Menu > Channel/Scan > **Scan ON/OFF**)

1. Push [Menu] to display the Menu screen.
2. Push [P2 (Up)] or [P1 (Down)] to select "Channel/Scan," then push [OK].

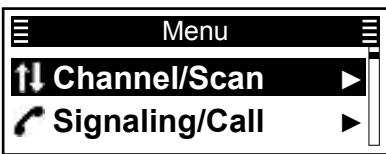

3. Push [P2 (Up)] or [P1 (Down)] to select "Scan ON/OFF," then push [OK].



4. Push [Up] or [Down] to select "ON," then push [OK].

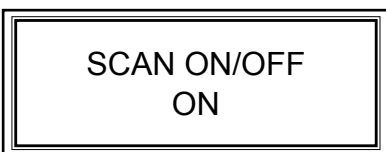
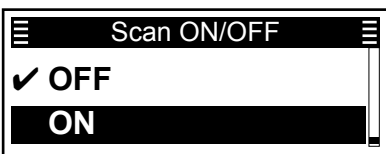

- The Scan starts.
- "Scan ON/OFF ON" is briefly displayed.
- ① When a signal is detected, the Scan pauses on the channel until the signal disappears, then the Scan resumes.

5. Hold down [Back] for 1 second to return to the standby screen.
 - "A" blinks while scanning. (Depending on the transceiver version.)

Canceling a Scan

(Menu > Channel/Scan > Scan ON/OFF)

1. Push [Menu] to display the Menu screen.
2. Push [P2 (Up)] or [P1 (Down)] to select "Channel/Scan," then push [OK].

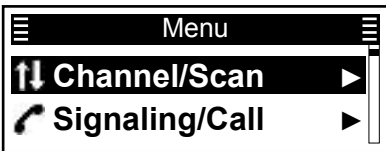

3. Push [P2 (Up)] or [P1 (Down)] to select "Scan ON/OFF," then push [OK].

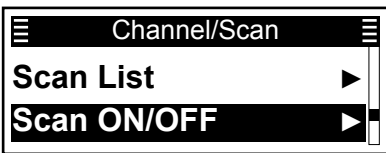

4. Push [P2 (Up)] or [P1 (Down)] to select "OFF," then push [OK].

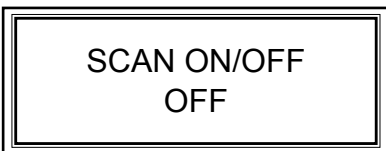
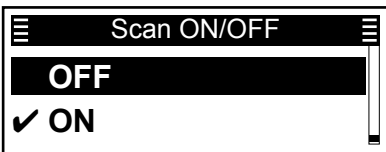

- The Scan stops.
 - "Scan ON/OFF OFF" is briefly displayed.
5. Hold down [Back] for 1 second to return to the standby screen.
 - "Z" disappears. (Depending on the transceiver version.)

Selecting a Scan list

You can select a Scan list to be scanned. Channels included in the selected Scan list are scanned during a scan. When selecting a Zone type Scan list, the channels that are in the same Zone as the Scan start channel will be scanned.

(Menu > Channel/Scan > **Scan List**)

1. Push [Menu] to display the Menu screen.
2. Push [P2 (Up)] or [P1 (Down)] to select "Channel/Scan," then push [OK].

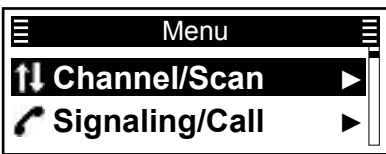

3. Push [P2 (Up)] or [P1 (Down)] to select "Scan List," then push [OK].

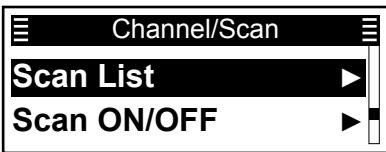

4. Push [P2 (Up)] or [P1 (Down)] to select a list, then push [OK].

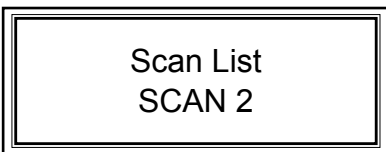
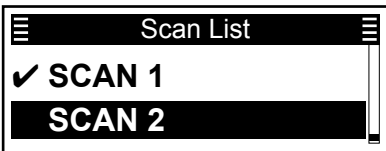

• The selected Scan list is briefly displayed and set.

5. Hold down [Back] for 1 second to return to the standby screen.

Setting or clearing a Scan tag

You can set or clear a Scan tag to or from a channel in a Scan list.

The Scan tag channel is a target channel during a Scan.

In a current Scan list:

1. Select a channel. (p. 3-4)
2. Push [Scan Add/Del (Tag)] to set or clear a Scan tag to or from the channel.

- "★" is displayed for a Scan tag channel.

When setting a Scan tag:

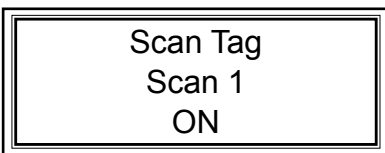

- The screen above is briefly displayed.

When clearing a Scan tag:

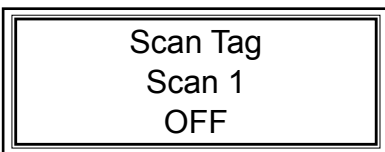

- The screen above is briefly displayed.

In a current Scan list:

(Menu > Channel/Scan > Scan Tag)

1. Select a channel. (p. 3-4)
2. Push [Menu] to display the Menu screen.
3. Push [P2 (Up)] or [P1 (Down)] to select "Channel/Scan," then push [OK].

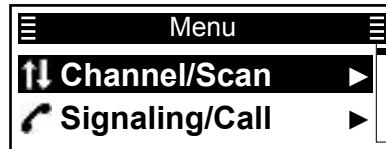

4. Push [P2 (Up)] or [P1 (Down)] to select "Scan Tag," then push [OK].



5. Push [P2 (Up)] or [P1 (Down)] to select a list, then push [OK].

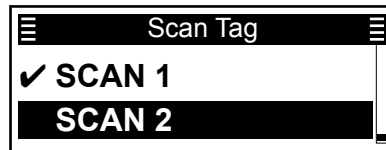

When setting a Scan Tag:

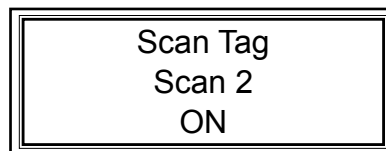

- The screen above is briefly displayed.

When clearing a Scan Tag:

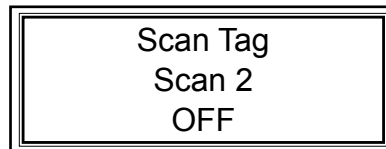

- The screen above is briefly displayed.

6. Hold down [Back] for 1 second to return to the standby screen.

Menu screen description	6-2
◇ Categories	6-2
◇ Using the Menu screen	6-3
Menu items	6-4
Channel/Scan	6-8
Signaling/Call	6-9
Trunking	6-10
Functions	6-10
GPS	6-11
Voice Rec (Voice Recording)	6-11
Audio Setting	6-12
Bluetooth	6-13
Vibration	6-14
Sensor	6-14
Display	6-15
Utility	6-16
Information	6-17













Menu screen description

Open the “Menu” screen using the [Menu] key. In the “Menu” screen, the setting items are categorized. Depending on the presetting, you can select various functions and set the transceiver settings in the “Menu” screen.

NOTE: The language displayed on the “Menu” screen is set to English by default, but a dealer can change it to another language using the programming software. In this case, the item names are displayed on the screen in the language set by the dealer, instead of English.

◇ Categories

Push [P2 (Up)] or [P1 (Down)] to select a category.

Icon	Category	Icon	Category
	Channel/Scan		Bluetooth
	Signaling/Call		Vibration
	Trunking		Sensor
	Functions		Display
	GPS		Utility
	Voice Rec		Information
	Audio Setting		

Menu screen description

◇ Using the Menu screen

Example: Starting a Scan

1. Push [Menu] to display the Menu screen.
2. Push [P2 (Up)] or [P1 (Down)] to select “Channel/Scan,” then push [OK].

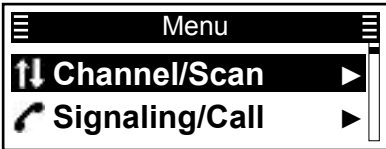

3. Push [P2 (Up)] or [P1 (Down)] to select “Scan ON/OFF,” then push [OK].



4. Push [P2 (Up)] or [P1 (Down)] to select “ON,” then push [OK].

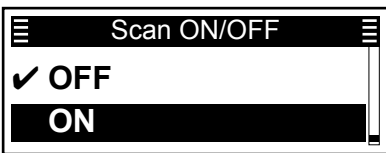

• The Scan starts.

5. Hold down [Back] for 1 second to return to the standby screen.

Menu items

In the Menu screen, the items are categorized, as shown below.

Channel/Scan	C.Tone CH Sel (C. Tone Channel Select) Sets the Continuous tone channel.	p. 6-8
	Compander Turns the Compander function ON or OFF.	p. 6-8
	Priority A CH (Priority A Channel) Selects the Priority A channel.	p. 6-8
	Prio A (RW) (Priority A Rewrite) Sets a current channel as the Priority A channel.	p. 6-8
	Priority B CH (Priority B Channel) Selects the Priority B channel.	p. 6-8
	Prio B (RW) (Priority B Rewrite) Sets a current channel as the Priority B channel.	p. 6-8
	CC CH Select Sets the CC channel.	p. 6-8
	RF Power Selects the output power for each channel.	p. 6-8
	Scan Tag Sets or clears a Scan tag to or from a channel in a Scan list.	p. 6-8
	Scan List Sets a Scan list to be scanned.	p. 6-8
	Scan ON/OFF Starts or cancels a Scan.	p. 6-8
	Scrambler Turns the Voice Scrambler function ON or OFF.	p. 6-8
	Talk Around Turns the Talk Around function ON or OFF.	p. 6-8
	Zone Select Selects a Zone.	p. 6-8
Signaling/Call	Call List Select Selects a calling destination.	p. 6-9
	Call Menu Selects a calling destination and a call type.	p. 6-9
	Clear Incoming Clears the received call log from the Incoming list.	p. 6-9
	Clear Outgoing Clears the transmit call log from the Outgoing list.	p. 6-9
	DTMF Autodial Displays the "DTMF Autodial" screen. The preset DTMF codes are selectable.	p. 6-9
	Group Select Displays the "Group Select" screen. The preset Group IDs are selectable.	p. 6-9
	Incoming Displays a log of the received calls.	p. 6-9
	INDIV Select (Individual Select) Displays the "Individual Select" screen. The preset Individual IDs are selectable.	p. 6-9
	Message Displays the "Message" screen. The preset Messages are selectable.	p. 6-9
	Outgoing Displays a log of the transmit calls	p. 6-9

► Continued on the next page

Menu items

Signaling/Call	Status Displays the "Status" screen. The preset Status messages are selectable.		p. 6-9
	Telephone Enables the user to connect to a telephone network.		p. 6-9
	Write Message Enables the user to directly enter a message.		p. 6-9
Trunking	Acquisition Selects a number for the Control CH Acquisition Parameter.		p. 6-10
	Call Back Turns the Call Back function ON or OFF.		p. 6-10
	Retention Selects a number for the Control CH Retention Parameter.		p. 6-10
	Roaming Reqst (Roaming Request) Turns the Roaming Request function ON or OFF.		p. 6-10
	Site Select Selects a site.		p. 6-10
	Site Lock Turns the Site Lock function ON or OFF.		p. 6-10
Functions	Lone Worker Turns the Lone Worker function ON or OFF.		p. 6-10
	Surveillance Turns the Surveillance function ON or OFF.		p. 6-10
	VOX Turns the VOX function ON or OFF.		p. 6-10
	VOX Delay Sets the VOX Delay.		p. 6-10
	VOX Gain Sets the VOX gain.		p. 6-10
GPS	GPS Position	My Position Displays the transceiver's current location.	p. 6-11
		RX List Displays the received call that includes location data.	p. 6-11
Voice Rec (Voice Recording)	Call Recorder Turns the audio recording function ON or OFF.		p. 6-11
	Play Call Rec (Play Call Record) Enables the user to play back the recorded audio.		p. 6-11
Audio Setting	AF Max Level (AF Maximum Level) Sets the maximum audio output level.		p. 6-12
	AF Min Level (AF Minimum Level) Sets the minimum audio output level.		p. 6-12
	Mic Gain (Microphone Gain) Sets the microphone sensitivity.		p. 6-12
	R Noise Cancel (RX Noise Cancel) Selects whether or not to suppress the receive audio noise to make the audio easy to hear.		p. 6-12
	T Noise Cancel (TX Noise Cancel) Selects whether or not to suppress the microphone input noise to make the audio easy to hear.		p. 6-12
	RX EQ Effect (RX Equalizer Effect) Selects the RX Equalizer Effect.		p. 6-12
	TX EQ Effect (TX Equalizer Effect) Selects the TX Equalizer Effect.		p. 6-12

► Continued on the next page

Menu items

Bluetooth	Bluetooth Turns the Bluetooth function ON or OFF.	p. 6-13
	Bluetooth Reset Resets the Bluetooth unit.	p. 6-13
	Auto Connect Select whether or not to automatically connect to a paired Bluetooth device when its power is turned ON.	p. 6-13
	Audio Select Selects the AF Output device when a Bluetooth headset is connected.	p. 6-13
	Bluetooth info (Bluetooth Information) Displays the installed Bluetooth unit name.	p. 6-13
	Device List Displays the paired Bluetooth devices.	p. 6-13
	Key Bp (VS3) (Key Beep (VS-3)) Sets the beep sound when the VS-3 Bluetooth® HEADSET Custom Key ([PLAY]/[FWD]/[RWD]) is pushed.	p. 6-13
	PWR Sv (VS3) (Power Save (VS-3)) Selects whether to operate in the Bluetooth headset's Battery Saving mode when the VS-3 Bluetooth® HEADSET is connected.	p. 6-13
	PTT Bp (VS3) (PTT Beep (VS-3)) Sets the beep sound when [PTT] is pushed on the VS-3 Bluetooth® HEADSET.	p. 6-13
	1 Touch PTT (One-Touch PTT) Sets the One-Touch PTT function when a Bluetooth headset is connected.	p. 6-13
	Wait to Pair Enters the pairing request wait mode.	p. 6-13
Vibration	OP Vibration (Opening Vibration) Selects whether or not to vibrate the transceiver when it is turned ON.	p. 6-14
	Vibration Turns the Vibration function ON or OFF.	p. 6-14
	Key Vibration Selects whether or not to vibrate the transceiver when a user pushes a key.	p. 6-14
Sensor	Man Dwn Ang (Man Down Angle) Sets the Emergency mode detection angle for the Man Down function.	p. 6-14
	Motion Sense (Motion Sensitivity) Sets the acceleration sensor sensitivity to detect whether the user is moving or not, for the Motion Detection function.	p. 6-14
	Stat Sense (Stationary Sensitivity) Sets the acceleration sensor sensitivity to detect if the user is stationary or not for the Stationary Detection function.	p. 6-14
Display	Backlight Sets the Key Backlight status.	p. 6-15
	Contrast Sets the LCD contrast level.	p. 6-15
	LCD Test Checks whether or not the LCD displays correctly.	p. 6-15

Menu items

Utility	Sys Beep Lv (System Beep Level) Sets the System Beep output level.	p. 6-16
	Emr Beep Lv (Emergency Beep Level) Sets the Beep output level when in the Emergency mode.	p. 6-16
	Key Beep Lv (Key Beep Level) Sets the Key-touch Beep output level.	p. 6-16
	Side Tone Lv (Side Tone Level) Set the Side Tone Beep output level.	p. 6-16
	OP Beep Lv (Opening Beep Level) Sets the Opening Beep output level.	p. 6-16
	Ringer Lv (Ringer Level) Sets the Ringer output level.	p. 6-16
	SQL Level (Squelch Level) Sets the squelch level.	p. 6-16
	Warn Beep Lv (Warning Beep Level) Sets the Warning Beep output level.	p. 6-16
	Announce Lv (Announce Level) Sets the Beep output level for the Channel Announce function.	p. 6-16
Information	Battery Info (Battery Information) Displays the battery voltage.	p. 6-17
	Comment Displays the transceiver's comments.	p. 6-17
	Firmware Info (Firmware Information) Displays the transceiver's firmware information.	p. 6-17
	Own ID Displays the transceiver's unit ID.	p. 6-17
	RSSI/VER/MER Displays the transceiver's RSSI (Received Signal Strength Indication) level, VER (Vocoder Error Rate), and MER (Message Error Rate).	p. 6-17

Channel/Scan

C.Tone CH Sel

In the Analog mode

Sets a Continuous tone channel. (p. 3-5)

Compander

In the Analog mode

Turns the Compander function ON or OFF. This function reduces noise components on the transmit audio for clear communication.

Priority A CH

Selects the Priority A channel. (p. 3-4)

Prio A (RW)

Sets a current channel as the Priority A channel. (p. 3-5)

Priority B CH

Selects the Priority B channel. (p. 3-4)

Prio B (RW)

Sets a current channel as the Priority B channel. (p. 3-5)

CC CH Select

In the Digital mode

Sets a CC channel. (p. 3-6)

RF Power

Selects the output power for each channel.

• Options: Low 1, Low 2, High

① "Low 1" is the lowest power level, and "High" is the highest power level.

① Lower output power during short-range communications may reduce the possibility of interference to other stations.

Scan Tag

Sets or clears a Scan tag to or from a channel in a Scan list. (p. 5-5)

Scan List

Sets a Scan list to be scanned. (p. 5-4)

Scan ON/OFF

Starts or cancels a Scan.

A Scan checks for signals on each channel and stops when a signal is received.

Scrambler

In the Analog mode

Turns the Voice Scrambler function ON or OFF.

This function enables private communication between stations using a Scramble code.

① The same Scramble code must be set in all stations to communicate.

In the Digital mode

Turns the Voice Scrambler function ON or OFF.

This function enables private communication between stations using a Scrambler Key and Key ID.

① The same Encryption Key and Key ID must be set in all stations to communicate.

Talk Around

Turns the Talk Around function ON or OFF.

The Talk Around function equalizes the transmit frequency to the receive frequency, for direct (Simplex) communication.

Zone Select

Selects a Zone. (p. 3-3)

Signaling/Call

Call List Select

Selects a calling destination. After selecting, push [PTT] to transmit the voice call to the selected destination. (pp. 3-9, 7-3, 7-4, 8-3)

Call Menu

In the Analog mode

Selects a calling destination and a call type (Status, Message, or Write Message). you can select or directly enter a message before transmitting it. After selecting or entering a message, push [PTT] to transmit it. (pp. 7-4 ~ 7-6, 8-4, 8-5)

In the Digital mode

Selects a calling destination and a call type (Status, Message, Write Message, Ambience Listening, Stun, Revive, Kill, and Broadcast). After selecting, push [PTT] to transmit the call to the selected destination. (pp. 7-5 ~ 7-10)

NOTE: When the call type is “Status,” “Message,” or “Write Message,” you can select or directly enter a message before transmitting it. After selecting or entering a message, push [PTT] to transmit it. See pages 7-5 ~ 7-7 for details.

Clear Incoming

Clears the received call log from the Incoming list. (pp. 7-20, 8-10)

Clear Outgoing

In the Digital mode

Clears the transmit call log from the Outgoing list. (p. 7-22)

DTMF Autodial

Displays the “DTMF Autodial” screen. Then, push [P2 (Up)] or [P1 (Down)] to select a DTMF code. After selecting, push [PTT] to transmit the selected DTMF code.

Group Select

Displays the “Group Select” screen. Then, push [P2 (Up)] or [P1 (Down)] to select a Group ID from the Call List. After selecting, push [PTT] to transmit a Group call.

Incoming

Displays a log of the received Individual call, Status message, and Message. (pp. 7-20, 8-9)

INDIV Select

Displays the “Individual Select” screen. Then, push [P2 (Up)] or [P1 (Down)] to select a Individual ID from the Call List. After selecting, push [PTT] to send a Individual call.

Message

In the Analog mode (BIIS only)

In the Digital mode

Displays the “Message” screen. Then, push [P2 (Up)] or [P1 (Down)] to select a message. After selecting, push [PTT] to send the Message to the currently selected destination. (pp. 7-6, 8-5)

Outgoing

In the Digital mode

Displays a log of the transmitted Individual calls. (p. 7-22)

Status

Displays the “Status” screen. Then, push [P2 (Up)] or [P1 (Down)] to select a status message. After selecting, push [PTT] to send the message to the currently selected destination. (pp. 7-5, 8-4)

Telephone

In the Digital mode (dPMR™ Trunking only)

Displays the “Phone List” screen. Then, push [P2 (Up)] or [P1 (Down)] to select a phone number. After selecting, push [PTT] to connect to the telephone network.

Write Message

Enables the user to directly enter a Message. After entering, push [PTT] to transmit it. (pp. 7-7, 8-6)

Trunking

Acquisition

In the Digital mode (dPMR™ Trunking only)

Selects a Control CH Acquisition Parameter to use. The Acquisition Parameter determines whether a site is out of the service range or not. (p. 7-14)

TIP: You can set the Control CH Acquisition Parameter using the programming software. See the programming software's Help file for details.

Call Back

In the Digital mode (dPMR™ Trunking only)

Turns the Call Back function ON or OFF. The Call Back function automatically sends back an acknowledgement (Call Back) to the caller station after receiving an Individual call. (p. 7-20)

Retention

In the Digital mode (dPMR™ Trunking only)

Selects a number for the Control CH Retention Parameter. The Retention Parameter determines whether a site is within the service range or not. (p. 7-15)

TIP: You can set the Control CH Retention Parameter using the programming software. See the programming software's Help file for details.

Roaming Request

In the Digital mode (dPMR™ Trunking only)

Turns the Roaming Request function ON or OFF. When this function is turned ON, the transceiver starts a Roaming Scan, regardless of the error rate. (p. 7-16)

① If the Site Lock function is turned ON, the transceiver resumes a Roaming Scan when this function is turned ON.

Site Select

In the Digital mode (dPMR™ Trunking only)

Displays the "Site Select" screen. Then, push [P2 (Up)] or [P1 (Down)] to select a site. After selecting, push [OK] to save. (p. 7-18)

Site Lock

In the Digital mode (dPMR™ Trunking only)

Turns the Site Lock function ON or OFF. When this function is turned ON, the transceiver cancels resuming a Roaming Scan, and stays on the current site, regardless of the error rate. (p. 7-17)

Functions

Lone Worker

Turns the Lone Worker function ON or OFF. When this function is ON, the transceiver automatically enters the Emergency mode if no operation occurs during the preset period of time.

Surveillance

Turns the Surveillance function ON or OFF. When this function is ON, beeps are not heard and the backlight and the Status indicator do not light, even when a signal is received, or a key is pushed.

VOX

Turns the VOX function ON or OFF. When this function is ON, the receive and transmit are automatically switched by detecting the user's voice.

NOTE: To use the function, a headset* and a VOX converter cable are required (purchase separately).
* A Bluetooth headset is also usable.

VOX Delay

Sets the VOX Delay. The VOX Delay is the period of time the transceiver continues transmitting after the user stops speaking, and then the VOX switches to receive.

- Range: 0.5 ~ 3.0 seconds

NOTE: If you set the time too short, a pause in a conversation may be regarded as the end of conversation, and the transceiver will start receiving, even as the conversation continues.

VOX Gain

Sets the VOX gain. The VOX function automatically switches between receive and transmit by detecting the user's voice.

- Range: 1 ~ 10

① Higher values make the VOX function more sensitive to sounds.

GPS

My Position

Displays the transceiver's current location.

- ① Only when the optional HM-233GP is connected to the transceiver.

RX List

Displays the received call log that includes position data. Push [P2 (Up)] or [P1 (Down)] to select the log, then push [OK].

TIP: The transceiver may receive position data with a Voice message, Status message, Message, or Emergency call.

Voice Rec (Voice Recording)

Call Recorder

Starts or stops the audio recording.

- "🗣️" is displayed when the Call Record function is ON.

① Information

- While holding down [PTT], "🗣️" blinks, and the communication audio is recorded.
- Once the recording has started, the recording will continue, even if the transceiver is restarted.
- To stop the recording, select "OFF."

Play Call Rec

Do the following steps to play back the recorded audio.

Select "Play Call Rec," then push [OK] to display the recorded files.

Playing back

1. Push [P2 (Up)] or [P1 (Down)] to select a file to play back, then push [OK].
2. Push [Play] to play back.
 - The selected file is played back.
 - See page 9-3 for details.
3. Hold down [Back] for 1 second to return to the standby screen.

Audio Setting

AF Max Level

Sets the maximum audio output level.
This function sets the maximum audio output level to inhibit the level from going higher than the set level.
• Range: 0 ~ 100

AF Min Level

Sets the minimum audio output level.
This function sets the minimum audio output level to inhibit the level from going lower than the set level.
• Range: 0 ~ 100

Mic Gain

Sets the microphone sensitivity.
• Range: -8 (Minimum) ~ 5 (Maximum).

① Higher values make the microphone more sensitive to the user's voice.

R Noise Cancel

Selects whether or not to suppress the receive audio noise to make the audio easy to hear.
• OFF: Turns OFF the function.
• 1, 2, or 3: Turns ON the function.
3 levels (1, 2, or 3) are selectable.

① Higher values suppress the noise more, but the audio quality is reduced.

T Noise Cancel

Selects whether or not to suppress the microphone input noise to make the audio easy to hear.
• OFF: Turns OFF the function.
• 1, 2, or 3: Turns ON the function.
3 levels (1, 2, or 3) are selectable.

① Higher values suppress the noise more, but the audio quality is reduced.

RX EQ Effect

Selects the RX Equalizer Effect.
• Flat: Normal audio
• High Boost: Emphasizes the high audio frequencies compared to "Flat"
• Mid Boost: Emphasizes the midrange audio frequencies compared to "Flat"
• Low Boost: Emphasizes the low audio frequencies compared to "Flat"
• Low Cut: Cuts the low audio frequencies compared to "Flat"
• Custom: User customized audio

TX EQ Effect

Selects the TX Equalizer Effect.
• Flat: Normal audio
• High Boost: Emphasizes the high audio frequencies compared to "Flat"
• Mid Boost: Emphasizes the midrange audio frequencies compared to "Flat"
• Low Boost: Emphasizes the low audio frequencies compared to "Flat"
• Low Cut: Cuts the low audio frequencies compared to "Flat"
• Custom: User customized audio

Bluetooth

Bluetooth

Turns the Bluetooth function ON or OFF.

- OFF: Turns OFF the function.
- ON: Turns ON the function.

Bluetooth Reset

Resets the Bluetooth unit.

Resetting can be done only when the Bluetooth function is OFF.

Auto Connect

Select whether or not to automatically connect to a paired Bluetooth device when its power is turned ON.

- OFF: Does not connect to a paired device.
- ON: Automatically connects to the last connected device.

NOTE: If the last connection is operated with the Bluetooth device, the transceiver tries to connect to the device even if this item is set to OFF.

Audio Select

Selects the AF Output device when a Bluetooth headset is connected.

- Only RMT: Sets the Bluetooth headset as the AF Output device.
- RMT & SP: Sets the Bluetooth headset and the transceiver's speaker as the AF Output devices.

Bluetooth info

Displays the installed Bluetooth unit name, address, supported profile, and its version information.

Device List

Displays the paired Bluetooth devices.

To find other Bluetooth device, select "Find Device."

① See pages 10-4 ~10-5 for details.

Key Bp (VS3)

Sets the beep sound when the optional VS-3 Bluetooth® HEADSET Custom Key ([PLAY]/[FWD]/[RWD]) is pushed.

- OFF: No beep sounds.
- ON: A beep sounds.

PWR Sv (VS3)

Selects whether to operate in the Bluetooth headset's Battery Saving mode when the optional VS-3 Bluetooth® HEADSET is connected. When the Power Save is activated, the user cannot use the VOX function.

NOTE: When a third-party headset or a data device is connected, this function is automatically set to OFF, even if this item has been set to ON.

- OFF: Turns OFF the function.
- ON: The Power Save mode is enabled when no communication or operation is performed for 120 seconds.

PTT Bp (VS3)

Sets the beep sound when [PTT] is pushed on the optional VS-3 Bluetooth® HEADSET.

- OFF: No beep sounds.
- ON: A beep sounds.

1 Touch PTT

Sets the One-Touch PTT function when the Bluetooth headset is connected. The function enables a user to transmit without continuously holding down [PTT].

NOTE: When a third-party headset is connected, this function may automatically be set to ON, even if this item has been set to OFF.

- OFF: Push [PTT] to transmit, release to receive.
- ON: Push [PTT] to transmit, push again to receive.

Wait to Pair

Enters the pairing request wait mode. The transceiver waits for a pairing request from a Bluetooth device.

Vibration

OP Vibration

Selects whether or not to vibrate the transceiver when it is turned ON.

- ① To use this function, the Vibration function must be turned ON, in advance.
- OFF: Turns OFF the vibration.
- Pattern 01: The transceiver vibrates for 5 seconds.
- Pattern 02: The transceiver vibrates for 1 second three times.
- Pattern 03: The transceiver vibrates for 0.5 seconds five times.
- Pattern 04: The transceiver vibrates for 0.3 seconds eight times.
- Pattern 05 to 16: The transceiver vibrates, according to the customized pattern.

NOTE: You can customize the Vibration pattern, Vibration Repeat, and Interval time using the programming software.

Vibration

Turns the Vibration function ON or OFF.

- ① To vibrate the transceiver, set each Vibration setting to ON using the programming software.

Depending on the Vibration setting, the transceiver may vibrate:

- When a call that includes a matching 2-Tone code is received.
- When a call that includes a matching 5-Tone code is received.
- When a Message is received.
- When a Status call that includes a matching status number is received.
- When a DTMF code is received.
- When a user pushes a key.
- While in the Low Battery 1 state.
- While in the Low Battery 2 state.
- While in the Surveillance mode.

Key Vibration

Selects whether or not to vibrate the transceiver when a user pushes a key.

- ① To use this function, the Vibration function must first be turned ON.

Sensor

Man Dwn Ang

Sets the Emergency mode detection angle for the Man Down function. If the transceiver leans past the set angle for the ON Timer time period, the transceiver enters the Emergency mode, and then a countdown starts.

- Options: 45, 60, or 75 degrees

Motion Sense

Sets the acceleration sensor sensitivity to detect whether the user is moving or not, for the Motion Detection function. This setting is for the Motion Detection function, and it determines the acceleration threshold level to activate the Motion Detection Timer.

- Range: 1 (high sensitivity) ~ 10 (low sensitivity).
- ① If you set a lower level, the transceiver will enter the Emergency mode sooner.

Stat Sense

Sets the acceleration sensor sensitivity to detect if the user is stationary or not for the Stationary Detection function. This setting is used for the Stationary Detection function, and it determines the acceleration threshold level to activate the Stationary Detection's ON Timer (Sec).

- Range: 1 (high sensitivity) ~ 10 (low sensitivity).
- ① If you set at a higher level, the transceiver will enter the Emergency mode sooner.

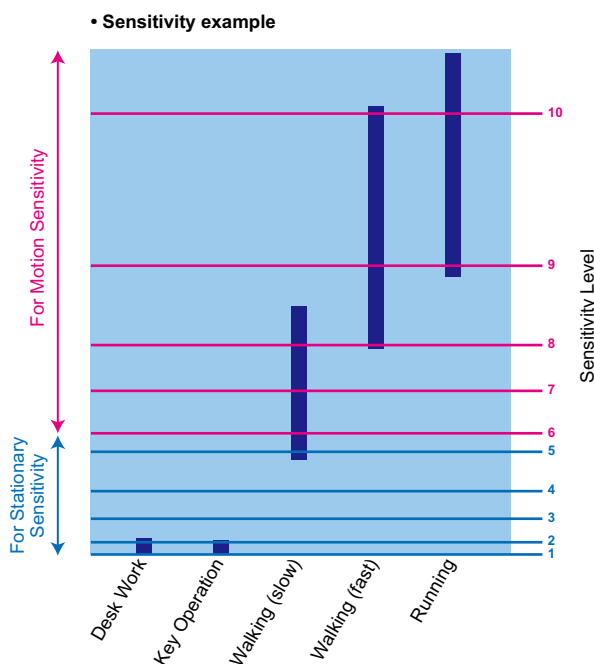

Display

Backlight

Sets the Key Backlight status.

- OFF: Turns the display backlight OFF.
- Auto: When any key except [PTT] is pushed, the backlight lights for 5 seconds.
- ON: Turns the backlight continuously ON.

Contrast

Sets the LCD contrast level.

- Range: 0 (the lowest) ~ 50 (the highest)

LCD Test

Checks whether or not the LCD displays correctly.

Utility

Sys Beep Lv

Sets the System Beep output level.
The beep sounds when connecting to or is locked out of the System. When a Linked option is selected, the beep level is adjustable with [VOL].
• Range: 1 ~ 5, 1 (Linked) ~ 5 (Linked), or OFF

NOTE: The lockout timer and TOT beeps cannot be turned OFF.

Emr Beep Lv

Sets the Beep output level when in the Emergency mode.
When a Linked option is selected, the beep level is adjustable with [VOL].
• Range: 1 ~ 5, 1 (Linked) ~ 5 (Linked), or OFF

Key Beep Lv

Sets the Key-touch Beep output level.
When a Linked option is selected, the beep level is adjustable with [VOL].
• Range: 1 ~ 5, 1 (Linked) ~ 5 (Linked), or OFF

Side Tone Lv

Set the Side Tone Beep output level.
2-Tone, 5-Tone or DTMF code signals are output as the Side Tone Beeps. When a Linked option is selected, the beep level can be adjusted with [VOL].
• Range: 1 ~ 5, 1 (Linked) ~ 5 (Linked), or OFF

OP Beep Lv

Sets the Opening Beep output level.
When a Linked option is selected, the beep level is adjustable with [VOL].
• Range: 1 ~ 5, 1 (Linked) ~ 5 (Linked), or OFF

Ringer Lv

Sets the Ringer output level.
When a Linked option is selected, the Ringer level is adjustable with [VOL].
• Range: 1 ~ 5, 1 (Linked) ~ 5 (Linked), or OFF

SQL Level

Sets the squelch level.
• Range: 0 (open) ~ 9 (tight)

Warning Beep Lv

Sets the Warning Beep output level.
The Warning Beep sounds when:
• the battery is exhausted.
• the Encryption key fails.

When a Linked option is selected, the beep level is adjustable with [VOL].
• Range: 1 ~ 5, 1 (Linked) ~ 5 (Linked), or OFF

Announce Lv

Sets the Beep output level for the Channel Announce function.
The transceiver announces the selected channel number.
When a Linked option is selected, the beep level is adjustable with [VOL].
• Range: 1 ~ 5, 1 (Linked) ~ 5 (Linked), or OFF

Information

Battery Info

Displays the battery voltage (Voltage), the remaining charge (Charge), the number of times charged (Cycle Count), the battery health (Health), and the battery model (Model).

Comment

Displays the transceiver's comment. Comment 1 is displayed on the upper line, and the Comment 2 is on the lower line.

Firmware Info

Displays the transceiver's firmware information. When an optional unit is installed, you can also check the unit information. Depending on the installed unit, only the name may be displayed.

Own ID

Displays the transceiver's unit ID.

RSSI/VER/MER

Displays the transceiver's RSSI (Received Signal Strength Indication) level, VER (Vocoder Error Rate), and MER (Message Error Rate).

dPMR™ operation.....	7-2
Transmitting a call	7-2
◇ General	7-2
◇ Transmitting an Individual call.....	7-3
◇ Transmitting a Talkgroup call	7-4
◇ Transmitting a Status message	7-5
◇ Transmitting a Message.....	7-6
◇ Directly entering message	7-7
◇ Transmitting an Ambience Listening call.....	7-8
◇ Transmitting a Stun command	7-9
◇ Transmitting a Revive command	7-9
◇ Transmitting a Kill command.....	7-10
◇ Transmitting a Broadcast call.....	7-10
◇ Transmitting an Emergency call	7-11
◇ Transmitting Position data	7-11
Receiving a call	7-12
◇ Receiving an Individual call	7-12
◇ Receiving a Group call.....	7-12
◇ Receiving a Status message	7-12
◇ Receiving a Message	7-12
◇ Receiving an Ambience Listening call	7-13
◇ Receiving a Stun, Kill or Revive.....	7-13
◇ Receiving a Broadcast call	7-13
◇ Receiving an Emergency call	7-13
Selecting the Acquisition Parameter (For the Trunking operation)	7-14
Selecting the Retention Parameter (For the Trunking operation).....	7-15
Roaming function (For the Trunking operation).....	7-16
◇ Roaming Request function	7-16
Site Lock function (For the Trunking operation).....	7-17
Site Select function (For the Trunking operation).....	7-18
Call Back function (For the Trunking operation).....	7-19
Incoming list.....	7-20
◇ Displaying the Incoming list	7-20
◇ Deleting the Incoming list.....	7-21
Outgoing list.....	7-22
◇ Displaying the Outgoing list	7-22
◇ Deleting the Outgoing list.....	7-22
Encryption function.....	7-23
Analog Talk Back function (For the Conventional operation).....	7-23

dPMR™ operation

The transceiver provides digital Private Mobile Radio (dPMR™) operation that meets the 6.25 kHz bandwidth requirements for narrow band operation. This increases the efficiency of channel allocation and use of the spectrum.

NOTE: In the dPMR™ mode, BIIS 1200 operation is disabled.

Transmitting a call

dPMR™ operation enables you to make a call to a specific station (Individual call) or to a particular group (Talkgroup call). Other digital mode transceivers on the channel will not receive a call whose ID or code does not match their Individual or Talkgroup ID and/or CC*.

◇ General

The target ID (Individual ID or Talkgroup ID) and TX CC* are preset to a channel. To make a call, you should select the desired channel that your target station is set to.

After making an Individual call, the transceiver waits for an acknowledgement for a preset period of time. If no acknowledgement is received, the transceiver automatically repeats the call 4 times (default). However, when no acknowledgement is received after the fourth call, an error beep sounds and the transceiver automatically returns to the Standby mode.

NOTE: When the “Called Party Check” item is set to OFF using the CS-F52D PROGRAMMING SOFTWARE, the communication is established even if no acknowledgement is received on the Conventional channel.
(dPMR > Subscriber Configuration > dPMR Common > Call Option > **Call Setting (Conventional)**)

*You can select the desired CC on only the Conventional channel.

Transmitting a call

◇ **Transmitting an Individual call**

(Menu > Signaling/Call > **Call List Select**)

1. Push [Menu] to display the Menu screen.
2. Push [P2 (Up)] or [P1 (Down)] to select “Signaling/Call,” then push [OK].

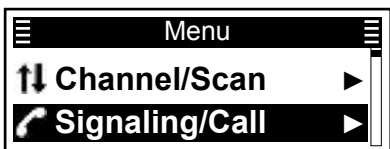

3. Push [P2 (Up)] or [P1 (Down)] to select “Call List Select,” then push [OK].



4. Push [P2 (Up)] or [P1 (Down)] to select an Individual station.



5. Push [PTT] to transmit an Individual call.
 6. Hold down [PTT] to transmit.
 7. Release [PTT] to receive.
 8. After the communication is finished, push [Back].
 - The transceiver sends a Disconnect signal to terminate the call.
- ① Either station can send a Disconnect signal.

TIP:

- You can also select an Individual station in the “Individual Select” screen.
(Menu > Signaling/Call > **INDIV Select**)
- You can also transmit an Individual call through the Call Menu.
(Menu > Signaling/Call > **Call menu**)
- When an Individual ID is set in the Memory CH, you can transmit an Individual call by pushing [PTT] on the channel.
- Push [Call List Select] to directly display the “Call List Select” screen in step 4 to the left.

Transmitting a call

◇ Transmitting a Talkgroup call

You can call a specific Talkgroup station.

(Menu > Signaling/Call > **Call List Select**)

1. Push [Menu] to display the Menu screen.
2. Push [P2 (Up)] or [P1 (Down)] to select “Signaling/Call,” then push [OK].

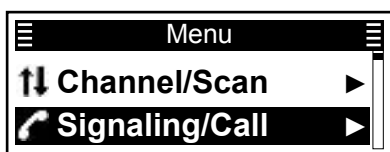

3. Push [P2 (Up)] or [P1 (Down)] to select “Call List Select,” then push [OK].

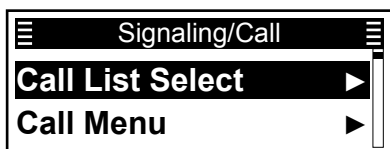

4. Push [P2 (Up)] or [P1 (Down)] to select a Talkgroup ID.

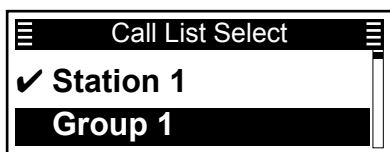

5. Push [PTT] to transmit a Talkgroup call.
 6. Hold down [PTT] to speak.
 7. Release [PTT] to receive.
 8. After the communication is finished, push [Back].
 - The transceiver sends a Disconnect signal to terminate the call.
- ① Either station can send a Disconnect signal.

TIP:

- You can also select a Talkgroup in the “Group Select” screen.
(Menu > Signaling/Call > **Group Select**)
- You can also transmit a Talkgroup call through the Call Menu.
(Menu > Signaling/Call > **Call menu**)
- When a Talkgroup ID is set in the Memory CH, you can transmit the Talkgroup call by pushing [PTT] on the channel.
- Push [Call List Select] to directly display the “Call List Select” screen in step 4 to the left.

Transmitting a call

◇ **Transmitting a Status message**

You can transmit a preset simple message. You cannot transmit a voice signal at the same time.

(Menu > Signaling/Call > **Call Menu**)

1. Push [Menu] to display the Menu screen.
2. Push [P2 (Up)] or [P1 (Down)] to select “Signaling/Call,” then push [OK].

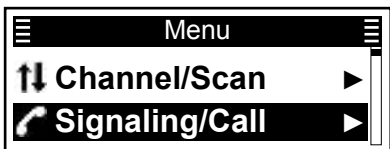

3. Push [P2 (Up)] or [P1 (Down)] to select “Call Menu,” then push [OK].

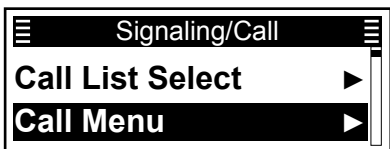

4. Push [P2 (Up)] or [P1 (Down)] to select an Individual or Talkgroup ID, then push [OK].

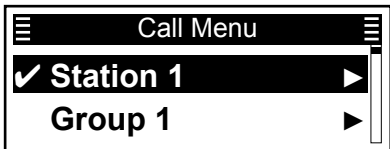

5. Push [P2 (Up)] or [P1 (Down)] to select “Status,” then push [OK].

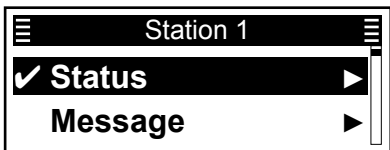

6. Push [P2 (Up)] or [P1 (Down)] to select a Status message, then push [PTT] to transmit it.

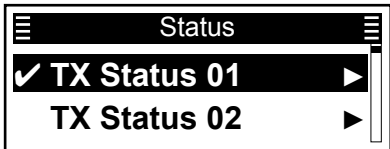

- “Success” is displayed when an acknowledgment is received from the targeted station.
- “Failed” is displayed if an acknowledgment is not received from the targeted station.

NOTE: If the following settings are configured using the CS-F52D PROGRAMMING SOFTWARE, the Status message can be automatically transmitted when:

- The transceiver is turned ON or OFF
- ① Set the Status message to be transmitted in **Power ON Status** or **Power OFF Status**.
- ① Set the target station ID in **Power Status ID**.
(dPMR > Subscriber Configuration > dPMR Common > Status > **Status Setting**)
- [PTT] is released
- ① Set the “**Send with Log-off**” item to “ON.”
(dPMR > Subscriber Configuration > dPMR Common > Status > **Status Setting**)
- ① Set the Status message to be transmitted.

TIP:

- You can also transmit a Status message through **Status**.
(Menu > Signaling/Call > **Status**)
- Push [Status] to directly display the “Status” screen in step 6 to the left.
- Hold down [Status] for 1 second to transmit the preset Status message that is set in the “Status” screen.

Transmitting a call

◇ **Transmitting a Message**

You can transmit a message of up to 100 characters.

(Menu > Signaling/Call > **Call Menu**)

1. Push [Menu] to display the Menu screen.
2. Push [P2 (Up)] or [P1 (Down)] to select “Signaling/Call,” then push [OK].

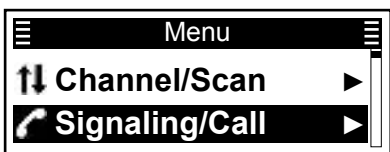

3. Push [P2 (Up)] or [P1 (Down)] to select “Call Menu,” then push [OK].

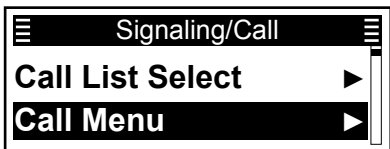

4. Push [P2 (Up)] or [P1 (Down)] to select an Individual or Talkgroup ID, then push [OK].

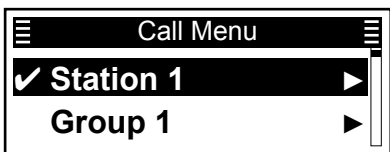

5. Push [Up] or [Down] to select “Message,” then push [OK].

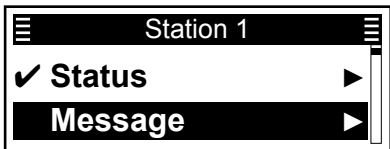

6. Push [Up] or [Down] to select a Message, then push [PTT] to transmit it.

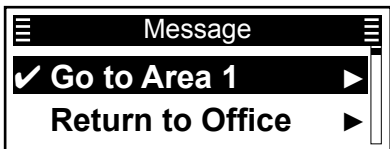

- “Success” is displayed when an acknowledgment is received from the targeted station.
 - “Failed” is displayed if an acknowledgment is not received from the targeted station.
- ① After selecting a Message, push [OK] to display the “Message Display” screen to see the whole message. The Message can be up to 100 characters.

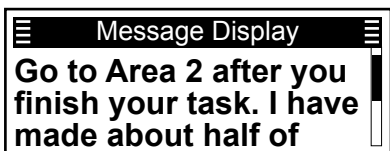

TIP:

- You can also transmit a Status message through **Message**.
(Menu > Signaling/Call > **Message**)
- Push [Message] to directly display the “Message” screen in step 6 to the left.
- Hold down [Message] for 1 second to transmit the preset Status message that is set in the “Message” screen.

Transmitting a call

◇ **Directly entering message**

You can directly enter a message and send it to the target station or group.

(Menu > Signaling/Call > **Write Message**)

1. Push [Menu] to display the Menu screen.
2. Push [P2 (Up)] or [P1 (Down)] to select “Signaling/Call,” then push [OK].

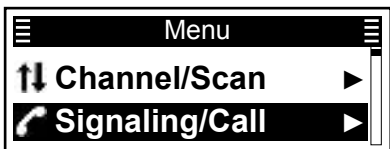

3. Push [P2 (Up)] or [P1 (Down)] to select “Write Message,” then push [OK].

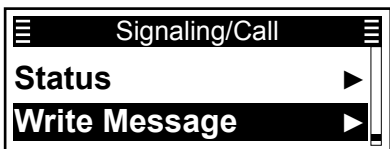

4. Enter a message of up to 100 characters.

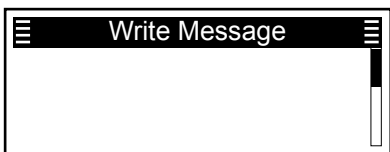

① **Information**

- To enter the character, rotate [Rotary Encoder] and push [P2 (Up)].
Usable characters: a ~ z, A ~ Z, 0 ~ 9,
/ + - = \ . ! ? ' , * # "
- To move the cursor, push [P2 (Up)] or [P1 (Down)].
- To insert a space, push [P2 (Up)] twice.
- To delete, push [Back].

5. After entering, push [PTT] to send it.

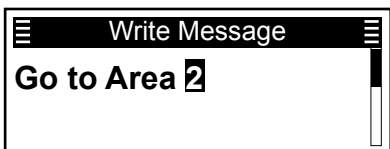

- “Success” is displayed when an acknowledgment is received from the targeted station.
- “Failed” is displayed if an acknowledgment is not received from the targeted station.

TIP:

- The entered message can be temporary saved. After entering a Message in step 5, push [OK] to display “Save Msg?.” Push [P2 (Up)] or [P1 (Down)] to select “Yes,” then push [OK] to save. However, once the transceiver is turned OFF, the saved message is deleted.



- Push [Write Message] to directly display the “Write Message” screen in step 4 to the left.

Transmitting a call

◇ **Transmitting an Ambience Listening call**

An Ambience Listening call enables you to send a command that will require the target station to transmit its microphone audio.

NOTE: This function is enabled only when the same status number is set between stations.

(Menu > Signaling/Call > **Call Menu**)

1. Push [Menu] to display the Menu screen.
2. Push [P2 (Up)] or [P1 (Down)] to select “Signaling/Call,” then push [OK].

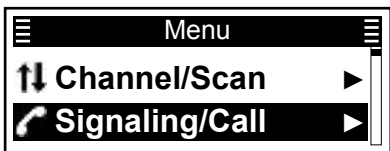

3. Push [P2 (Up)] or [P1 (Down)] to select “Call Menu,” then push [OK].

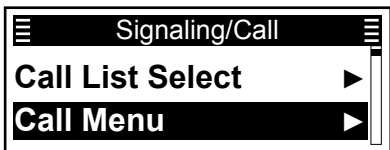

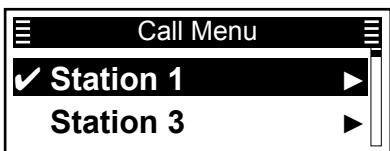

4. Push [P2 (Up)] or [P1 (Down)] to select the Individual ID, then push [OK].



5. Push [P2 (Up)] or [P1 (Down)] to select “Ambience Listening,” then push [PTT] to transmit the Ambience Listening call.



- The target station transmits the microphone audio.
- “” is displayed and the target station’s microphone audio is heard for the preset period of time.
- “” may be displayed or blink, depending on the presetting.
- ① “Success” is displayed after receiving an acknowledgement from the target station.
- ① “Failed” is displayed if the target station does not send back an acknowledgement and the microphone audio.

TIP: Hold down [Ambience Listening] for 1 second to transmit an Ambience Listening call.

Transmitting a call

◇ Transmitting a Stun command

A Stun command enables you to send a signal that will stun the target station. If a Stun command is received, the target station cannot operate the transceiver until a Revive command is received, or the password is input.

NOTE: This function is enabled only when the same status number is set between stations.

(Menu > Signaling/Call > **Call Menu**)

1. Push [Menu] to display the Menu screen.
2. Push [P2 (Up)] or [P1 (Down)] to select “Signaling/Call,” then push [OK].

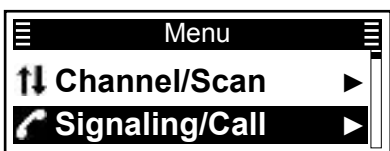

3. Push [P2 (Up)] or [P1 (Down)] to select “Call Menu,” then push [OK].

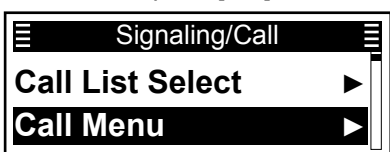

4. Push [P2 (Up)] or [P1 (Down)] to select the Individual ID, then push [OK].

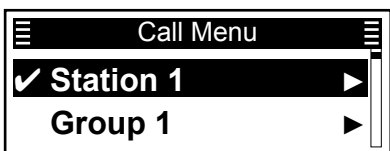

5. Push [P2 (Up)] or [P1 (Down)] to select “Stun,” then push [PTT] to transmit the Stun command.

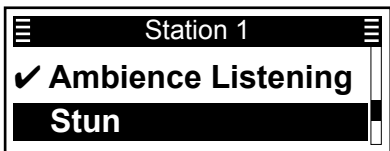

- “Success” is displayed when an acknowledgment is received from the targeted station. The target station is stunned.
- “Failed” is displayed if an acknowledgment is not received from the targeted station.

◇ Transmitting a Revive command

A Revive command enables you to send a signal that will revive a stunned station.

NOTE: This function is enabled only when the same status number is set between stations.

(Menu > Signaling/Call > **Call Menu**)

1. Push [Menu] to display the Menu screen.
2. Push [P2 (Up)] or [P1 (Down)] to select “Signaling/Call,” then push [OK].



3. Push [P2 (Up)] or [P1 (Down)] to select “Call Menu,” then push [OK].

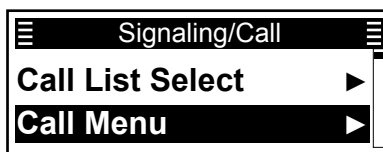

4. Push [P2 (Up)] or [P1 (Down)] to select an Individual ID, then push [OK].

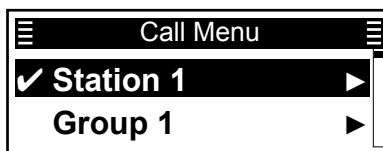

5. Push [P2 (Up)] or [P1 (Down)] to select “Revive,” then push [PTT] to transmit the Revive command.

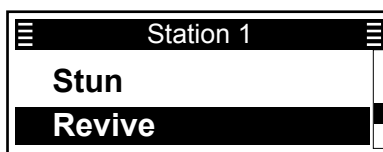

- The stunned station is revived.
- “Success” is displayed when an acknowledgment is received from the targeted station.
- “Failed” is displayed if an acknowledgment is not received from the targeted station.

Transmitting a call

◇ Transmitting a Kill command

A Kill command enables you to send a signal that will disable the target station. If a Kill command is received, the target station cannot operate the transceiver until it is reprogrammed.

NOTE: This function is enabled only when the same status number is set between stations.

(Menu > Signaling/Call > **Call Menu**)

1. Push [Menu] to display the Menu screen.
2. Push [P2 (Up)] or [P1 (Down)] to select “Signaling/Call,” then push [OK].

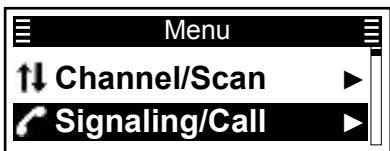

3. Push [P2 (Up)] or [P1 (Down)] to select “Call Menu,” then push [OK].

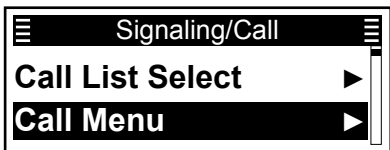

4. Push [P2 (Up)] or [P1 (Down)] to select the Individual ID, then push [OK].

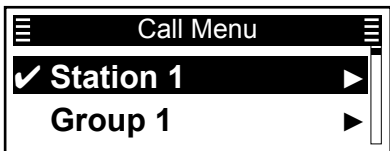

5. Push [P2 (Up)] or [P1 (Down)] to select “Kill,” then push [PTT] to transmit the Kill command.

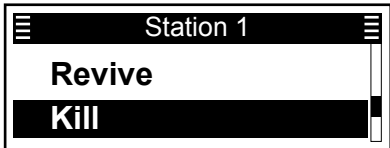

- The target station is disabled.
- “Success” is displayed when an acknowledgment is received from the targeted station.
- “Failed” is displayed if an acknowledgment is not received from the targeted station.

◇ Transmitting a Broadcast call

A Broadcast call enables you to announce a voice message to transceivers that have the same Talkgroup ID.

(Menu > Signaling/Call > **Call Menu**)

1. Push [Menu] to display the Menu screen.
2. Push [P2 (Up)] or [P1 (Down)] to select “Signaling/Call,” then push [OK].

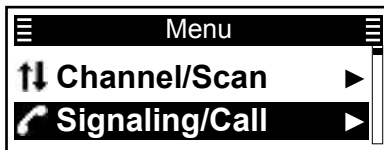

3. Push [P2 (Up)] or [P1 (Down)] to select “Call Menu,” then push [OK].

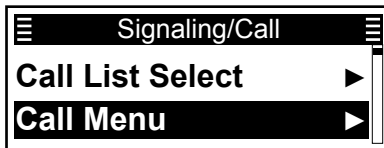

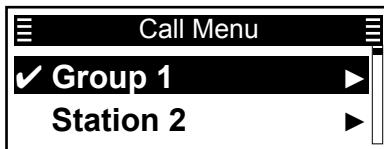

4. Push [P2 (Up)] or [P1 (Down)] to select the Talkgroup ID, then push [OK].



5. Push [P2 (Up)] or [P1 (Down)] to select “Broadcast,” then push [PTT] to transmit the Revive command.



- “” and “” are displayed.
6. Hold down [PTT] to transmit.
 7. After the announcement is finished, push [Back].
 - The transceiver sends a Disconnect signal to terminate the call.
- ① Only the caller station can send a Disconnect signal.

Transmitting a call

◇ **Transmitting an Emergency call**

A dPMR Emergency call can be transmitted in the same way as the 2-Tone, 5-Tone, or BIIS 1200 signaling operation. See “Emergency call” for details. (pp. 4-3 ~ 4-6)

◇ **Transmitting Position data**

When the GPS function is ON, and the optional HM-233GP GPS SPEAKER MICROPHONE receives Position data, the longitude and latitude data can be automatically transmitted:

- When a GPS request status message is received.
- After releasing [PTT].
(Only for the Conventional operation)
 - ① Set the **Send with Log-off** to “Enable.”
- After sending a Status Message.
 - ① Set the **Send with Status Call** to “Enable.”
- After sending a Message.
 - ① Set the **Send with Message Call** to “Enable.”
- After sending an Emergency call.
 - ① Set the **Send with Emergency** to “Enable.”
- At the preset interval.
 - ① Set the **Auto** to “Enable.”
 - ① Set the **Interval Timer [mm:ss]**.



NOTE: To transmit position data, the settings above are required using the CS-F52D PROGRAMMING SOFTWARE.

- (GPS > **Digital**)
- (GPS > Common > **Auto-Timed GPS Send**)

Receiving a call

◇ Receiving an Individual call

When an Individual call is received:

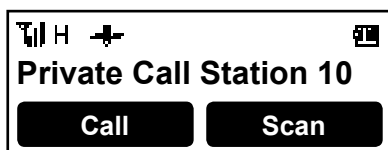

- Beeps sound.
- “” is displayed and Mute is released.
- “” may be displayed or blink, depending on the presetting.
- The Status indicator lights green.
- “Private Call” and the calling station name (or ID) is displayed while receiving the signal.



1. Hold down [PTT] to transmit.
 2. Release [PTT] to receive.
 3. After the communication is finished, push [Back].
- The transceiver sends a Disconnect signal to terminate the call.
 - “” disappears, and “Clear Down” is displayed for approximately 2 seconds.
- ① Either station can send a Disconnect signal.
 ② The transceiver returns to the Standby mode.

◇ Receiving a Group call

When a Group call is received:

- Beeps sound.
 - “” is displayed and Mute is released.
 - “” may be displayed or blink, depending on the presetting.
 - The Status indicator lights green.
 - The Group name and the calling station name (or ID) are alternately displayed while receiving the signal.
- ① When an All Call is received, “All Call” is displayed. In that case, you cannot reply to it.

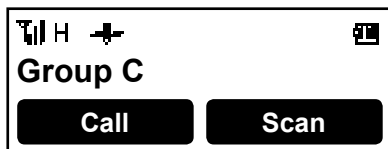

1. Hold down [PTT] to transmit.
2. Release [PTT] to receive.



NOTE: Only 1 station can speak at the same time.

3. After the communication is finished, push [Back].
 - The transceiver sends a Disconnect signal to terminate the call.
 - “” disappears, and “Clear Down” is displayed for approximately 2 seconds, then the transceiver returns to the Standby mode.

① Only the caller station can send a Disconnect signal.

◇ Receiving a Status message

When a Status message is received:

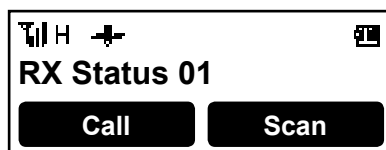

- Beeps sound.
- The Status message and the calling station or Group name (or ID) are alternately displayed.
- “” blinks.*
- “” may be displayed or blink, depending on the presetting.*
- May vibrate, depending on the presetting.



Push [Back] to stop the display indication.

◇ Receiving a Message

When a Message is received:

- Beeps sound.
- The Message and the calling station or Group name (or ID) are alternately displayed.
- “” blinks.*
- “” may be displayed or blink, depending on the presetting.
- May vibrate, depending on the presetting.

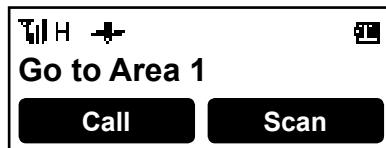

Push [Back] to stop the display indication.

Receiving a call

◇ Receiving an Ambience Listening call

When an Ambience Listening call is received from a specified station, the transceiver will automatically transmit its microphone audio.

NOTE: If the transceiver receives an Ambience Listening command from a station other than the specified one, the call will be ignored, and the transceiver will not transmit its microphone audio.

◇ Receiving a Stun, Kill or Revive

If a Stun or Kill command is received, the transceiver will display “Deactivated” and you cannot receive or transmit.*



If a Stun command is received, you cannot operate the transceiver until a Revive command is received, or the password is input.

If a Kill command is received, you cannot operate the transceiver until it is reprogrammed.

NOTE: Depending on the presetting, the transceiver can ignore the Stun, Revive and Kill commands that are from a non-specified station.

* Depending on the presetting, reception may be enabled.

◇ Receiving a Broadcast call

When an Emergency call is received:

- Beeps sound.
- “RX Broadcast” and the calling station name (or ID) are alternately displayed.
- “✉” blinks.



NOTE: Until receiving a Disconnect signal, the transmission is disabled.

◇ Receiving an Emergency call

When an Emergency call is received:

- Beeps sound.
- “RX Emergency” and the calling station name (or ID) are alternately displayed.
- “📞” is displayed and Mute is released.
- “🔄” may be displayed or blink, depending on the presettings.
- The transceiver automatically transmits an acknowledgement to the calling station.

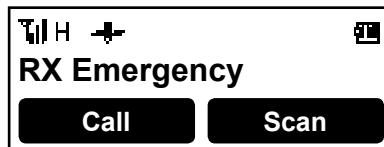

1. Hold down [PTT] to transmit.
2. After the communication is finished, push [Back].
 - The transceiver sends a Disconnect signal to terminate the call.
 - “📞” disappears, and “Clear Down” is displayed for approximately 2 seconds, then the transceiver returns to the Standby mode.

① Either station can send a Disconnect signal.

Selecting the Acquisition Parameter (For the Trunking operation)

You can manually select a number for the Control CH Acquisition Parameter. The Acquisition Parameter determines whether a site is out of the service range or not.

TIP: The Control CH Acquisition Parameter is programmed using the programming software. See the software's Help file for details.

(Menu > Trunking > **Acquisition**)

1. Push [Menu] to display the Menu screen.
2. Push [P2 (Up)] or [P1 (Down)] to select "Trunking," then push [OK].



3. Push [P2 (Up)] or [P1 (Down)] to select "Acquisition," then push [OK].

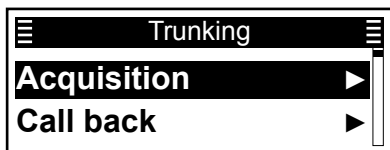

4. Push [P2 (Up)] or [P1 (Down)] to select the desired Acquisition Parameter number, then push [OK].

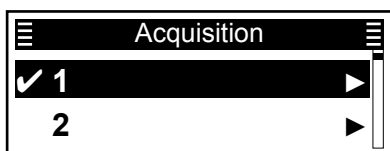

5. Hold down [Back] for 1 second to return to the standby screen.

Selecting the Retention Parameter (For the Trunking operation)

You can manually select a number for the Control CH Retention Parameter. The Retention Parameter determines whether a site is within the service range or not.

TIP: The Control CH Retention Parameter is programmed using the programming software. See the software's Help file for details.

(Menu > Trunking > **Retention**)

1. Push [Menu] to display the Menu screen.
2. Push [P2 (Up)] or [P1 (Down)] to select "Trunking," then push [OK].

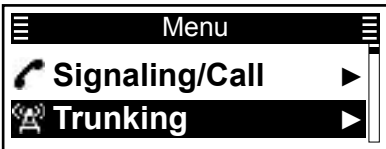

3. Push [P2 (Up)] or [P1 (Down)] to select "Retention," then push [OK].

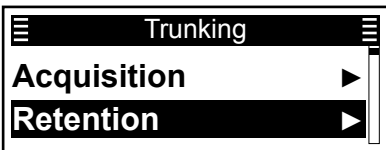

4. Push [P2 (Up)] or [P1 (Down)] to select the desired Retention Parameter number between 1 and 5, then push [OK].

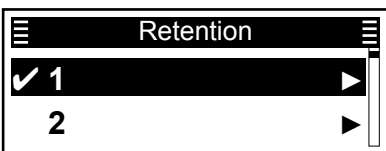

5. Hold down [Back] for 1 second to return to the standby screen.

Roaming function (For the Trunking operation)

The Trunking mode enables the transceiver to move to another site, according to the preset Short Hunt list*, in order to find a site that has a higher quality signal, or provides better services.

The Roaming function is automatically activated when the transceiver goes out of the range, and does not receive the downlink signal from the repeater in the currently registered site.

Depending on the presettings, the transceiver tries to register to the repeater that has the strongest RSSI level in the last registered site or an adjacent site. This roaming type takes more time than other roaming types.

The transceiver displays the channel text after the registration is complete.



The transceiver displays "Out of Range" when the transceiver cannot register to any site after searching.

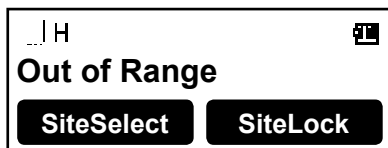

* The valid roaming areas (up to 100) are listed on the Site list.

◇ Roaming Request function

The Roaming Request function enables the transceiver to start or resume a Roaming scan, regardless of the error rate.

① Even if the Site Lock function is ON, and the transceiver is locked to the currently registered site, pushing [Roaming Request] resumes a Roaming scan.

(Menu > Trunking > **Roaming Reqst**)

1. Push [Menu] to display the Menu screen.
2. Push [P2 (Up)] or [P1 (Down)] to select "Trunking," then push [OK].

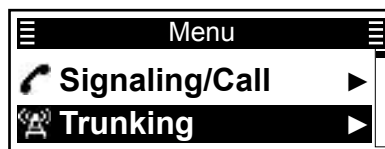

3. Push [P2 (Up)] or [P1 (Down)] to select "Roaming Reqst," then push [OK] to start or resume the Roaming scan.



4. Hold down [Back] for 1 second to return to the standby screen.

TIP: Push [Roaming Request] to start or resume the Roaming scan.

Site Lock function (For the Trunking operation)

You can lock the transceiver to the currently registered Site. When this function is ON, the transceiver cancels resuming a Roaming scan, and stays on the current Site, regardless of the error rate.

① “” is displayed when this function is turned ON.

(Menu > Trunking > **Site Lock**)

1. Push [Menu] to display the Menu screen.
2. Push [P2 (Up)] or [P1 (Down)] to select “Trunking,” then push [OK].

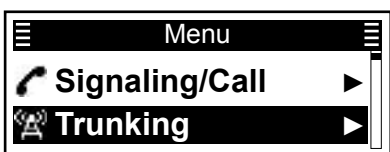

3. Push [P2 (Up)] or [P1 (Down)] to select “Site Lock,” then push [OK].



4. Push [P2 (Up)] or [P1 (Down)] to select “ON,” then push [OK] to turn on the Site Lock function.

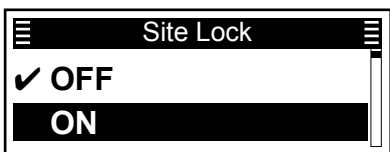

5. Hold down [Back] for 1 second to return to the standby screen.

TIP: Hold down [Site Lock] for 1 second to turn the Site Lock function ON or OFF.



Site Select function (For the Trunking operation)

You can manually select a site without a Roaming scan.

(Menu > Trunking > **Site Select**)

1. Push [Menu] to display the Menu screen.
2. Push [P2 (Up)] or [P1 (Down)] to select “Trunking,” then push [OK].

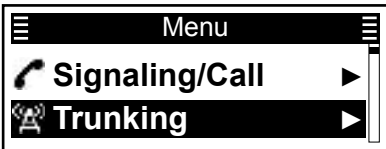

3. Push [P2 (Up)] or [P1 (Down)] to select “Site Select,” then push [OK].

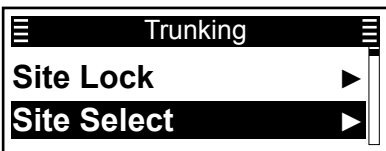

TIP: Push [Site Select] to directly display the “Site Select” screen in step 4 to the left.

4. Push [P2 (Up)] or [P1 (Down)] to select a site.

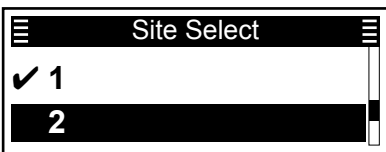

5. Push [OK] to set the selected site.
 - The transceiver tries to register to the selected site.

Call Back function (For the Trunking operation)

The Call Back function automatically sends back an acknowledgement (Call Back) to the caller station after receiving an Individual call.

- ① “Call Back” is displayed on the caller station’s display.
- ② The called station saves a log in the Incoming list.

(Menu > Trunking > **Call Back**)

1. Push [Menu] to display the Menu screen.
2. Push [P2 (Up)] or [P1 (Down)] to select “Trunking,” then push [OK].

TIP: Push [Call Back] to turn the Call Back function ON or OFF.



3. Push [Up] or [Down] to select “Call Back,” then push [OK].

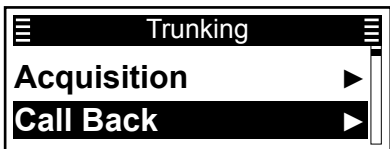

4. Push [Up] or [Down] to select “ON,” then push [OK] to turn ON the Call Back function.

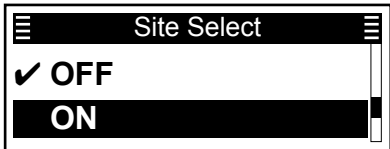

Incoming list

The transceiver can save a log of the received Individual calls, Call Back calls, Status Messages, and Messages in memory, depending on the presetting. Up to 10 Message/Status or 5 Voice calls can be saved in the log, and the oldest call record is deleted when an 11th (Message/Status) or 6th (Voice) call is received. However, once the transceiver is turned OFF, the all records are deleted.

◇ Displaying the Incoming list

(Menu > Signaling/Call > Incoming)

1. Push [Menu] to display the Menu screen.
2. Push [P2 (Up)] or [P1 (Down)] to select "Signaling/Call," then push [OK].

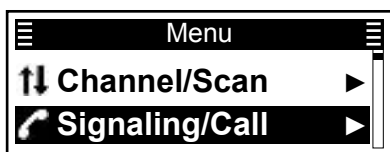

3. Push [P2 (Up)] or [P1 (Down)] to select "Incoming," then push [OK].

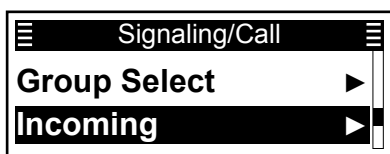

4. Push [P2 (Up)] or [P1 (Down)] to select "Voice" or "Message/Status," then push [OK].

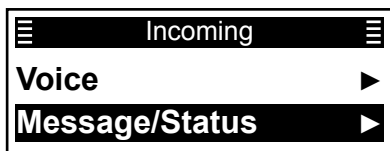

- Voice: The received Individual call logs are saved.
- Message/Status: The received Status message and Message logs are saved.

When "Voice" is selected in step 4:

The "Voice" screen is displayed.

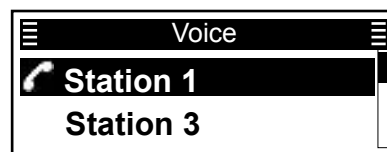

① "📞" is for Individual calls.

TIP: Skip step 5 and go to step 6.

When "Message/Status" is selected in step 4:

The "Message/Status" screen is displayed.

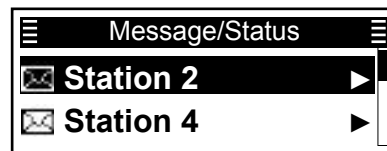

① "✉" is for Status message or Message.

5. Push [P2 (Up)] or [P1 (Down)] to select the log, then push [OK].
 - The message content is displayed.

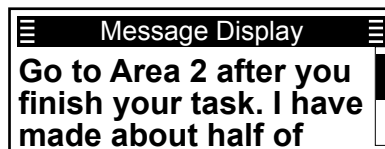

6. Hold down [Back] for 1 second to return to the standby screen.

Incoming list

◇ **Deleting the Incoming list**

The receive call log can be deleted from the Incoming list.

(Menu > Signaling/Call > **Clear Incoming**)

1. Push [Menu] to display the Menu screen.
2. Push [P2 (Up)] or [P1 (Down)] to select “Signaling/Call,” then push [OK].

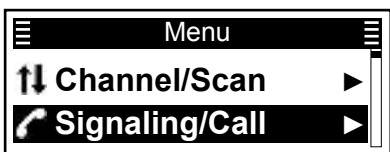

3. Push [P2 (Up)] or [P1 (Down)] to select “Clear Incoming,” then push [OK].

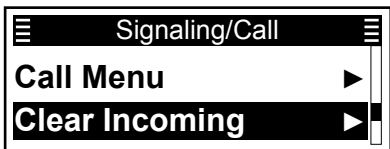

4. Push [P2 (Up)] or [P1 (Down)] to select “Voice” or “Message/Status” to be deleted, then push [OK].

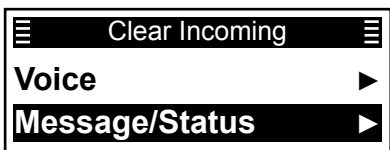

- Voice: The received Individual calls are in the log.
- Message/Status: The received Status messages and Messages are in the log.

5. After a dialog is displayed as shown below, push [P2 (Up)] or [P1 (Down)] to select <OK> on the screen and push [OK].



- The selected call log is deleted from the Incoming list.

6. Hold down [Back] for 1 second to return to the standby screen.

Outgoing list

The transceiver can save a log of the transmitted Individual calls in the memory, depending on the presetting.

Up to 5 calls can be saved in the log, and the oldest call record is deleted when a 6th call is received.

However, once the transceiver is turned OFF, the all records are deleted.

◇ Displaying the Outgoing list

(Menu > Signaling/Call > **Outgoing**)

1. Push [Menu] to display the Menu screen.
2. Push [P2 (Up)] or [P1 (Down)] to select "Signaling/Call," then push [OK].

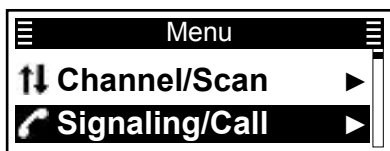

3. Push [P2 (Up)] or [P1 (Down)] to select "Outgoing," then push [OK].

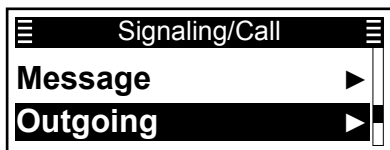

- The calling station name (or ID) is displayed in the "Outgoing" screen.

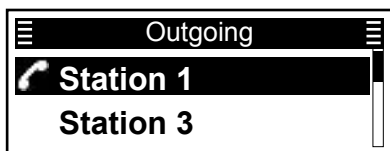

- ① "📞" is for Individual calls.

4. Hold down [Back] for 1 second to return to the standby screen.

◇ Deleting the Outgoing list

The transmit call log can be deleted from the Outgoing list.

(Menu > Signaling/Call > **Clear Outgoing**)

1. Push [Menu] to display the Menu screen.
2. Push [P2 (Up)] or [P1 (Down)] to select "Signaling/Call," then push [OK].

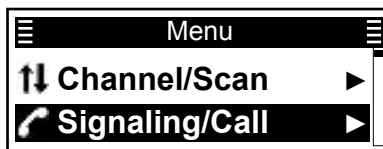

3. Push [P2 (Up)] or [P1 (Down)] to select "Clear Outgoing," then push [OK].



4. After a dialog is displayed as shown below, push [P2 (Up)] or [P1 (Down)] to select <OK> on the screen and push [OK].

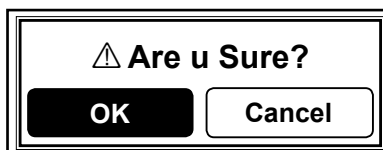

- The selected call log is deleted from the Outgoing list.

5. Hold down [Back] for 1 second to return to the standby screen.

Encryption function

The Encryption function enables voice scrambling, which provides private digital communication between stations.

When an encrypted call is received, the squelch will open only when the call contains a matching Key ID*. If a call containing a different Key ID* is made on the same channel, the squelch will not open, and the user will not hear the call.

* Depending on the presetting, opening the squelch may also require that a matching RAN is included in the call.

Push [Scrambler/Encryption] to toggle the Encryption function ON or OFF.

• “” is displayed when the Encryption function is ON.

① When the Encryption function is ON, push [PTT] to make an encrypted call.

Analog Talk Back function (For the Conventional operation)

When receiving an Analog signal on a "Mixed-Digi" channel, the Talk Back function enables transmitting an Analog signal during the Analog Talk Back timer period.

① After receiving an Analog signal on the "Mixed-Digi" channel, "ANALOG" is displayed during the Talk Back timer period. (Depending on the presetting)

NOTE: When this function is OFF, the transceiver always transmits Digital signals on the "Mixed-Digital" channels.

① On the "Mixed-Digital" channels, the transceiver can receive both Analog and Digital signals, regardless of this function setting.

BIIS 1200 system operation	8-2
Transmitting a call	8-3
◇ Transmitting an Individual call.....	8-3
◇ Transmitting a Group call.....	8-3
◇ Transmitting a Status Message	8-4
◇ Transmitting a Message.....	8-5
◇ Directly entering Message	8-6
◇ Transmitting an Emergency call.....	8-7
◇ Transmitting Position data	8-7
Receiving a call	8-8
◇ Receiving an Individual call	8-8
◇ Receiving a Group call.....	8-8
◇ Receiving a Status Message	8-8
◇ Receiving a Message	8-8
◇ Receiving an Emergency call	8-8
Incoming list.....	8-9
◇ Displaying the Incoming list	8-9
◇ Deleting the Incoming list.....	8-10

BIIS 1200 system operation

This function is usable in only the Analog mode.

The Binary Interchange of Information and Signalling (BIIS) 1200 standard is one of the best choices to add a data service to an existing system. It enables digital communications, signalling and message exchanges with analog transceivers. You can receive or transmit Individual calls, Group calls, Emergency calls, Status Messages, and Messages.

Set one of the assignable software key functions for the BIIS 1200 system operations. (pp. 2-9 ~ 2-13)

NOTE:

Set the related settings using the CS-F52D PROGRAMMING SOFTWARE when using the BIIS 1200 system. See its Help file for details.

Transmitting a call

◇ Transmitting an Individual call

(Menu > Signaling/Call > **Call List Select**)

1. Push [Menu] to display the Menu screen.
2. Push [P2 (Up)] or [P1 (Down)] to select “Signaling/Call,” then push [OK].

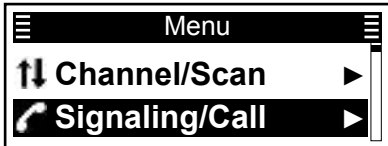

3. Push [P2 (Up)] or [P1 (Down)] to select “Call List Select,” then push [OK].

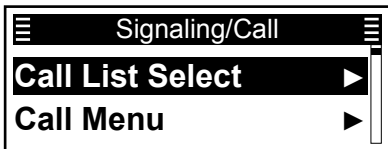

4. Push [P2 (Up)] or [P1 (Down)] to select an Individual ID.



5. Push [PTT] to transmit the Individual call.
 - “Connect” is displayed when an acknowledgment is received from the targeted station.
 - “Failed” is displayed if an acknowledgment is not received from the targeted station.
6. After “Connect” is displayed, hold down [PTT] to speak.
7. Release [PTT] to receive.
8. After the communication is finished, push [Back] to send a Clear down signal to terminate the connection.

TIP:

- Push [Call List Select] to directly display the “Call List Select” screen in step 4 above.
- You can also select the Individual ID in the “Individual Select” screen.
(Menu > Signaling/Call > **INDIV Select**)
- Push [Individual] to directly display the “Individual Select” screen.

◇ Transmitting a Group call

(Menu > Signaling/Call > **Call List Select**)

1. Push [Menu] to display the Menu screen.
2. Push [P2 (Up)] or [P1 (Down)] to select “Signaling/Call,” then push [OK].

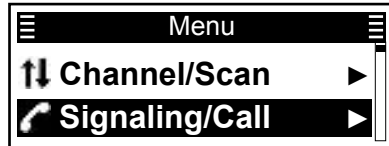

3. Push [P2 (Up)] or [P1 (Down)] to select “Call List Select,” then push [OK].

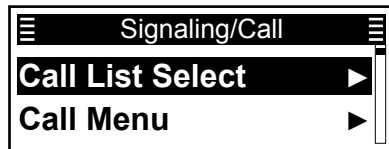

4. Push [P2 (Up)] or [P1 (Down)] to select a Group ID.

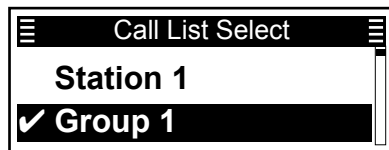

5. Push [PTT] to transmit the Group call.
6. Release [PTT] to receive.
7. After the communication is finished, push [Back] to send a Clear down signal to terminate the connection.

TIP:

- Push [Call List Select] to directly display the “Call List Select” screen in step 4 above.
- You can also select the Group ID in the “Group Select” screen.
(Menu > Signaling/Call > **Group Select**)
- Push [Group] to directly display the “Group Select” screen.

Transmitting a call

◇ **Transmitting a Status Message**

You can transmit a preset Status Message. You cannot transmit a voice call at the same time.

NOTE: Depending on the presetting, the Priority A channel is always used to send Status Messages.

(Menu > Signaling/Call > **Call Menu**)

1. Push [Menu] to display the Menu screen.
2. Push [P2 (Up)] or [P1 (Down)] to select “Signaling/Call,” then push [OK].

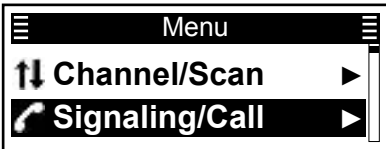

3. Push [P2 (Up)] or [P1 (Down)] to select “Call Menu,” then push [OK].

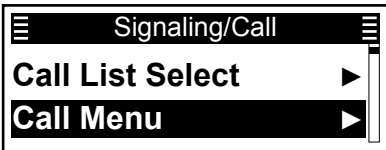

4. Push [P2 (Up)] or [P1 (Down)] to select an Individual or Group ID, then push [OK].

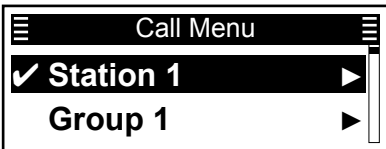

5. Push [P2 (Up)] or [P1 (Down)] to select “Status,” then push [OK].

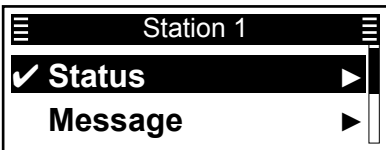

6. Push [P2 (Up)] or [P1 (Down)] to select a Status Message, then push [PTT] to transmit it.

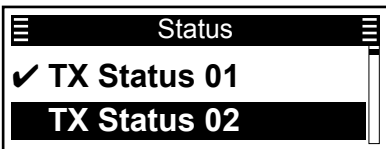

- “Success” is displayed when an acknowledgment is received from the targeted station.
- “Failed” is displayed if an acknowledgment is not received from the targeted station.

NOTE:

If the following settings are configured using the CS-F52D PROGRAMMING SOFTWARE, the Status Message can be automatically transmitted when:

- The transceiver is turned ON.
 - ① Set **Power ON Status 23** to “Enable.”
 - The transceiver is turned OFF.
 - ① Set **Power OFF Status 19** to “Enable.”
- (Analog > BIIS > Config > Status Setting)

TIP:

- You can also transmit a Status Message through **Status**.
(Menu > Signaling/Call > **Status**)
- Push [Status] to directly display the “Status” screen in step 4 to the left.
- Hold down [Status] for 1 second to transmit the preset Status Message that is set in the “Status” screen.

Transmitting a call

◇ **Transmitting a Message**

You can transmit a message of up to 14 characters.

(Menu > Signaling/Call > **Call Menu**)

1. Push [Menu] to display the Menu screen.
2. Push [P2 (Up)] or [P1 (Down)] to select “Signaling/Call,” then push [OK].

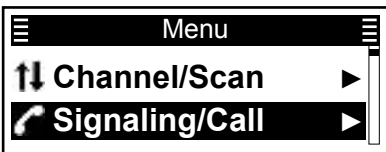

3. Push [P2 (Up)] or [P1 (Down)] to select “Call Menu,” then push [OK].

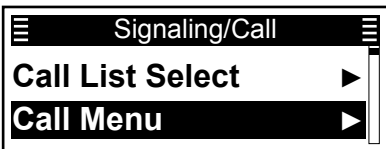

4. Push [P2 (Up)] or [P1 (Down)] to select an Individual or Group ID, then push [OK].

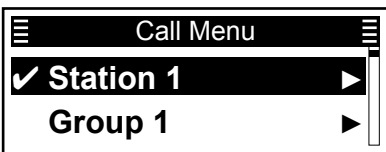

5. Push [P2 (Up)] or [P1 (Down)] to select “Message,” then push [OK].

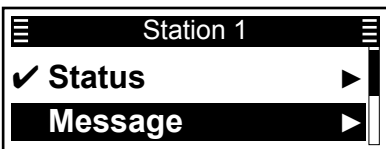

6. Push [P2 (Up)] or [P1 (Down)] to select a Message, then push [PTT] to transmit it.

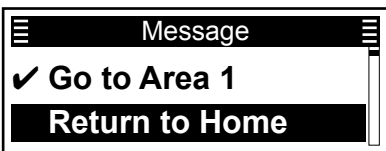

- “Success” is displayed when an acknowledgment is received from the targeted station.
- “Failed” is displayed if an acknowledgment is not received from the targeted station.

TIP:

- You can also transmit a Status Message through **Message**.
(Menu > Signaling/Call > **Message**)
- Push [Message] to directly display the “Message” screen in step 6 to the left.
- Hold down [Message] for 1 second to transmit the preset Status Message that is set in the “Message” screen.

Transmitting a call

◇ **Directly entering Message**

You can directly enter a Message, then send it to the target station or group.

(Menu > Signaling/Call > **Write Message**)

1. Push [Menu] to display the Menu screen.
2. Push [P2 (Up)] or [P1 (Down)] to select “Signaling/Call,” then push [OK].

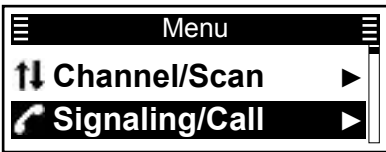

3. Push [P2 (Up)] or [P1 (Down)] to select “Write Message,” then push [OK].

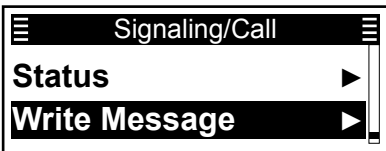

4. Enter a Message of up to 14 characters.

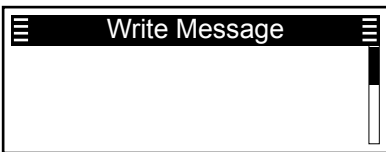

① **Information**

- To enter the character, rotate [Rotary Encoder] and push [P2 (Up)].
Usable characters: a ~ z, A ~ Z, 0 ~ 9,
/ + - = \ . ! ? ' , * # "
 - To move the cursor, push [P2 (Up)] or [P1 (Down)].
 - To insert a space, push [P2 (Up)] twice.
 - To delete, push [Back].
5. After entering, push [PTT] to send it.

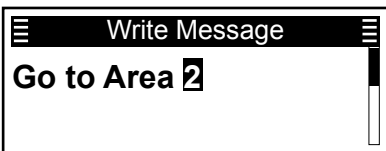

- “Success” is displayed when an acknowledgment is received from the targeted station.
- “Failed” is displayed if an acknowledgment is not received from the targeted station.

TIP:

- The entered Message can be temporary saved. After entering a Message in step 5, push [OK] to display “Save Msg?.” Push [P2 (Up)] or [P1 (Down)] to select “Yes,” then push [OK] to save. However, once the transceiver is turned OFF, the saved Message is deleted.



- Push [Write Message] to directly display the “Write Message” screen in step 4 to the left.

Transmitting a call

◇ **Transmitting an Emergency call**

When a BIIS channel is used as the Emergency channel, a BIIS Emergency call can be transmitted in the same way as in 2-Tone, 5-Tone, or dPMR™ signaling. See “Emergency call” for details. (pp. 4-3 ~ 4-6)

If your transceiver is configured for Silent operation, you can transmit Emergency calls without the beep sounding or the display changing.

The transceiver can also be set to keep the microphone open in the Emergency mode to monitor the situation, depending on the presetting.

◇ **Transmitting Position data**

When the GPS function is ON, and the optional HM-233GP GPS SPEAKER MICROPHONE receives Position data, the longitude and latitude data can be automatically transmitted:



- After sending a voice message.
 - ① Set **Send with Logoff** to “Enable.”
- After sending a Status Message.
 - ① Set **Send with Status Call** to “Enable.”
- After sending a Message.
 - ① Set **Send with Message Call** to “Enable.”
- After sending an Emergency call.
 - ① Set **Send with Emergency** to “Enable.”

NOTE: The settings above are required using the CS-F52D PROGRAMMING SOFTWARE.
(GPS > BIIS)

Receiving a call

◇ Receiving an Individual call

When an Individual call is received:

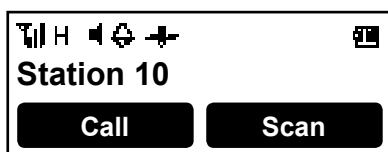

- The Status indicator lights green.
- “” may be displayed or blink, depending on the presetting.
- “” is displayed and the mute is released.
- The calling station name (or ID) is displayed while receiving the signal.



1. Hold down [PTT] to speak.
 2. Release [PTT] to receive.
 3. After the communication is finished, push [Back] to send a Clear Down signal to terminate the connection.
 - “CLR DOWN” is displayed.
 - “” disappears.
- ① Either station can send a Clear Down signal.

◇ Receiving a Group call

When a Group call is received:

- The Status indicator lights green.
- “” may be displayed or blink, depending on the presetting.
- “” is displayed and the mute is released.
- The Group name (or ID) is displayed while receiving the signal.

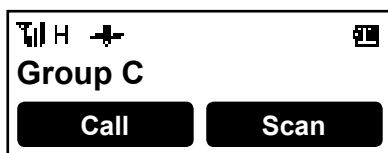

1. Hold down [PTT] to speak.

NOTE: Only one station can speak at a time.
 2. Release [PTT] to receive.
 3. After the communication is finished, push [Back] to send a Clear Down signal to terminate the connection.
 - “CLR DOWN” is displayed.
 - “” disappears.
- ① Any station can send a Clear Down signal.

◇ Receiving a Status Message

When a Status Message is received:

- Beeps sound.
- “” blinks.
- May vibrate, depending on the presetting.
- The Status Message and the calling station or Group name (or ID) are alternately displayed.

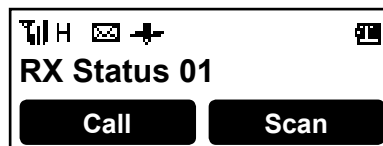

Push [Back] to stop the display indication.

◇ Receiving a Message

When a Message is received:

- Beeps sound.
- The Message and the calling station or Group name (or ID) are alternately displayed.
- “” blinks.
- May vibrate, depending on the presetting.

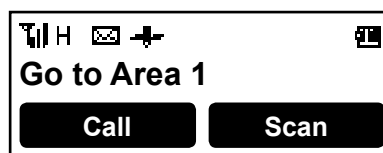

Push [Back] to stop the display indication.

◇ Receiving an Emergency call

When an Emergency call is received:

- Beeps sound.
- The Emergency text and the calling station name (or ID) are alternately displayed.
- “” blinks.
- May vibrate, depending on the presetting.

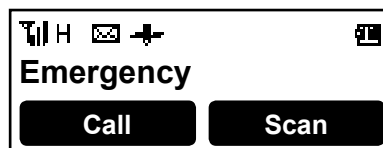

1. Hold down [PTT] to speak.
2. To stop the beep and display indication, turn OFF the transceiver, change the channel, or push [PTT] or a key.

Incoming list

The transceiver saves a log of the received Individual calls, Group calls, Status Messages, Messages and Emergency calls in the memory, depending on the presetting.

Up to 6 Status/Message/Emergency or 3 Voice calls can be saved in the log, and the oldest call record is deleted when an 7th (Status/Message) or 4th (Voice) call is received. However, once the transceiver is turned OFF, the all records are deleted.

◇ Displaying the Incoming list

(Menu > Signaling/Call > Incoming)

1. Push [Menu] to display the Menu screen.
2. Push [P2 (Up)] or [P1 (Down)] to select "Signaling/Call," then push [OK].

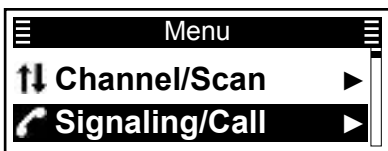

3. Push [P2 (Up)] or [P1 (Down)] to select "Incoming," then push [OK].

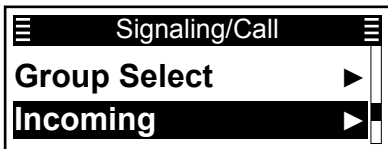

4. Push [P2 (Up)] or [P1 (Down)] to select "Voice" or "Message/Status," then push [OK].

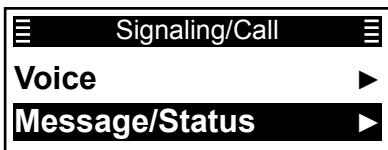

- Voice: The received Individual or Group call entries are saved in the log.
- Message/Status: The received Status Message and Message entries are saved in the log.

When "Voice" is selected in step 4:
The "Voice" screen is displayed.

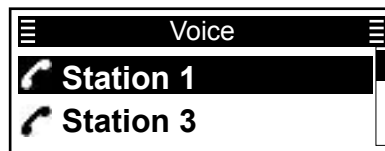

TIP: Skip step 5 and go to step 6.

When "Message/Status" is selected in step 4:
The "Message/Status" screen is displayed.

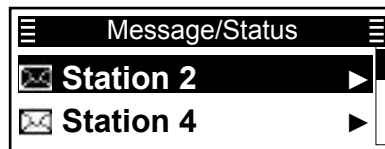

5. Push [P2 (Up)] or [P1 (Down)] to select the log, then push [OK].
 - The Message content is displayed.

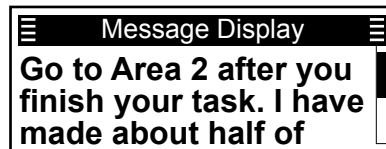

6. Hold down [Back] for 1 second to return to the standby screen.

Incoming list

◇ **Deleting the Incoming list**

The receive call log can be deleted from the Incoming list.

(Menu > Signaling/Call > **Clear Incoming**)

1. Push [Menu] to display the Menu screen.
2. Push [P2 (Up)] or [P1 (Down)] to select “Signaling/Call,” then push [OK].

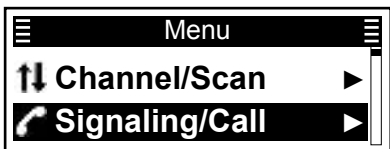

3. Push [P2 (Up)] or [P1 (Down)] to select “Clear Incoming,” then push [OK].

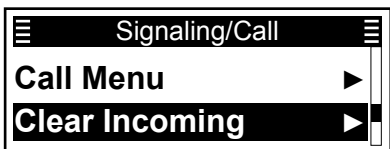

4. Push [P2 (Up)] or [P1 (Down)] to select “Voice” or “Message/Status” to be deleted, then push [OK].

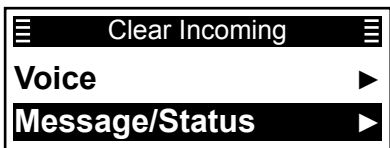

- Voice: The received Individual or Group call entries are saved in the entries.
- Message/Status: The received Status Message and Message entries are saved in the entries.

5. After a dialog is displayed as shown below, push [P2 (Up)] or [P1 (Down)] to select <OK> on the screen and push [OK].



- The selected call log is deleted from the Incoming list.

6. Hold down [Back] for 1 second to return to the standby screen.

Section 9

VOICE RECORDER FUNCTIONS

Recording a communication audio	9-2
Playing back a recorded audio	9-3

Recording a communication audio

This transceiver is equipped with a recorder not only for the receive audio, but also for transmit audio. This function is useful to make a communication record.

NOTE:

- The recording will continue until you turn OFF the function, or there is no more free space on the transceiver recording memory.
- When the recording time exceeds 8 minutes, the transceiver continues to record, but it records to a new file.

(Menu > Voice Rec > **Call Recorder**)

1. Push [Menu] to display the Menu screen.
2. Push [P2 (Up)] or [P1 (Down)] to select "Voice Rec," then push [OK].

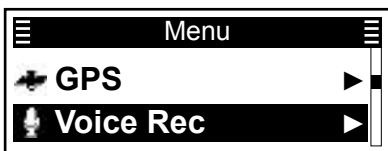

3. Push [P2 (Up)] or [P1 (Down)] to select "Call Recorder," then push [OK].



4. Push [P2 (Up)] or [P1 (Down)] to select "ON," then push [OK].

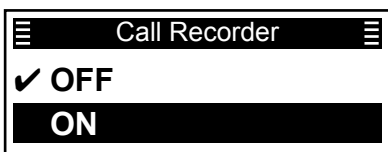

• The Call Record function is turned ON.

5. Hold down [Back] for 1 second to return to the standby screen.
 - "📞" is displayed.
6. Push [PTT] to start recording both RX and TX communication audio.
 - "📞" blinks while recording.
 - Records when the mute is released.

7. Do steps 1 ~ 3 to display the "Call Recorder" screen.
8. Push [P2 (Up)] or [P1 (Down)] to select "OFF," then push [OK].

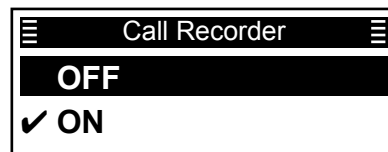

• The Call Record function is turned OFF.

9. Hold down [Back] for 1 second to return to the standby screen.
 - "📞" disappears.

TIP: Push [Call Recorder] to turn the Call Record function ON or OFF.

Playing back a recorded audio

(Menu > Voice Rec > **Play Call Rec**)

1. Push [Menu] to display the Menu screen.
2. Push [P2 (Up)] or [P1 (Down)] to select “Voice Rec,” then push [OK].

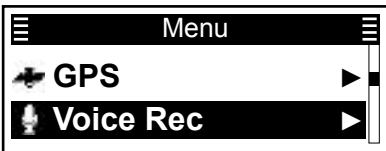

3. Push [P2 (Up)] or [P1 (Down)] to select “Play Call Rec,” then push [OK].



4. Push [P2 (Up)] or [P1 (Down)] to select a file, then push [OK].

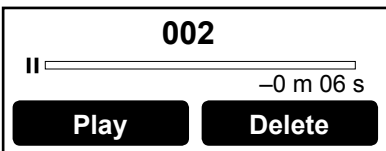
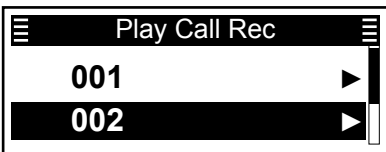

• The player screen is displayed.

5. Push [Play] to start a playback.

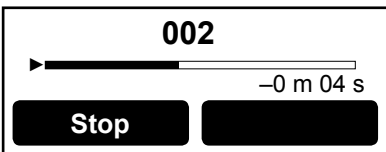

6. Hold down [Back] for 1 second to return to the standby screen.

TIP:

- Push [Stop] to stop a playback.
- Push [Delete] to delete the recorded file.
- Push [Play Call Record] to directly display the “Play Call Rec” screen.
- Push [Last Call Play] to play back a last recorded audio.

Section 10 Bluetooth® OPERATION

Bluetooth® Wireless Technology operation.....	10-2
◇ Electromagnetic Interference	10-2
Turning ON the Bluetooth® function	10-3
Pairing with a headset or a data device.....	10-4
Headset settings.....	10-6
◇ AF Output	10-6
◇ About the VS-3 headset.....	10-6
Accepting a pairing request from a Bluetooth® device	10-7
Disconnecting from a Bluetooth® device	10-9
Deleting a Bluetooth® device from the pairing list.....	10-10
Resetting the installed Bluetooth® unit	10-11
The maximum number of paired devices	10-12

Bluetooth® Wireless Technology operation

You can connect to other Bluetooth wireless technology enabled devices (Headset or Data) with the installed Bluetooth unit.

• Icom Headset

When you connect the optional VS-3 Bluetooth® HEADSET to the transceiver, you can wirelessly transmit and receive the headset audio.

The VS-3 has a [PTT] switch, so you can transmit in the same way as using the transceiver's [PTT] switch. The VOX function can also be used, so you can toggle transmit and receive by your voice through the headset microphone.

You can assign a desired key function to the keys on the side panel of the VS-3 to remotely operate the transceiver.

• Third party Headset

When you connect a third party's Bluetooth headset to the transceiver, you can wirelessly transmit and receive the audio.

• PC with Bluetooth

When you connect a PC with Bluetooth to a transceiver, you can use PC commands or Transparent data communication.

The communication range of Bluetooth is approximately 10 meters (33 feet).

NOTE: The Bluetooth communication range may vary, depending on the environment where you operate the device.

◇ Electromagnetic Interference

When you use a Bluetooth device, pay attention to the following:

Bluetooth devices operate in the 2.4 GHz band. The 2.4 GHz band is also used by other devices, such as Wireless LAN products, microwave ovens, RFID systems, amateur radio stations, and so on.

When using this device near such devices, interference may occur, causing a decrease in communication speed, and an unstable connection. In such cases, use this device away from the other devices, or stop using those devices.

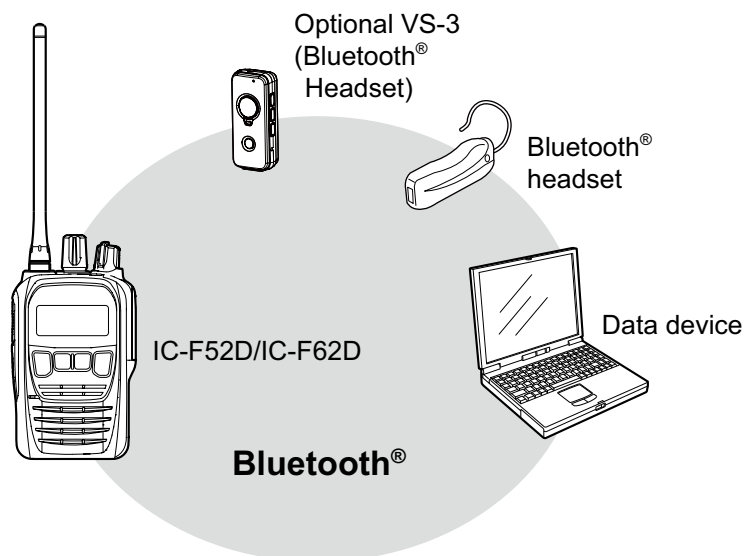

Turning ON the Bluetooth® function

(Menu > Bluetooth > **Bluetooth**)

1. Push [Menu] to display the “Menu” screen.
2. Push [P2 (Up)] or [P1 (Down)] to select “Bluetooth,” then push [OK].

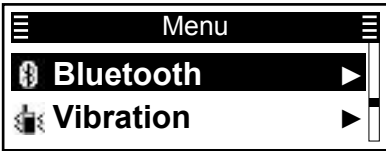

3. Push [P2 (Up)] or [P1 (Down)] to select “Bluetooth,” then push [OK].

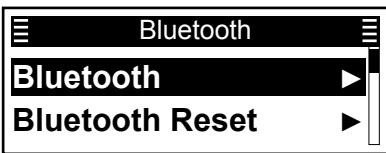

4. Push [P2 (Up)] or [P1 (Down)] to select “ON,” then push [OK].

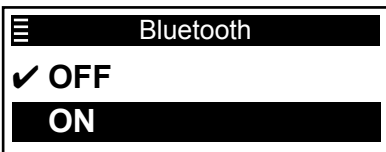

• The Bluetooth function is turned ON.

5. Hold down [Back] for 1 second to return to the standby screen.

TIP: You can also turn the Bluetooth function ON or OFF by pushing [Bluetooth].

Pairing with a headset or a data device

Step 1: Enter the Pairing mode (Device)

- See the Bluetooth device's instruction manual for details.

Step 2: Turn ON the Bluetooth function (Transceiver)

- See page 10-3 for details.

Step 3: Search for the device (Transceiver)

- Push [Menu] to display the "Menu" screen.
- Push [P2 (Up)] or [P1 (Down)] to select "Bluetooth," then push [OK].

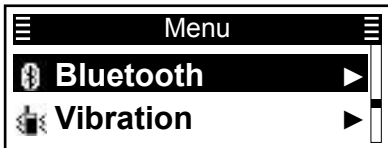

- Push [P2 (Up)] or [P1 (Down)] to select "Device List," then push [OK].



- Push [P2 (Up)] or [P1 (Down)] to select "Find Device," then push [OK].



TIP: If the transceiver has been connected to the Bluetooth device before, its name may be displayed in this step. In that case, push [P2 (Up)] or [P1 (Down)] to select it, then push [OK] to connect.

- Push [P2 (Up)] or [P1 (Down)] to select "Headset" or "Data Device," then push [OK] to start searching.

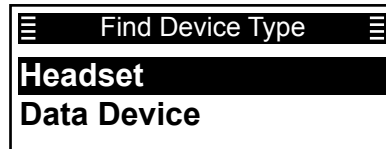

- When pairable devices are found, their names are displayed on the screen.

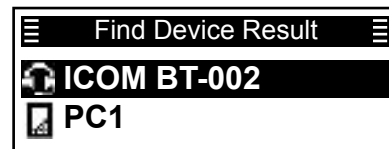

TIP: If the transceiver cannot find any pairable devices, the following screen is displayed. In that case, do step 4 to search for a device again.

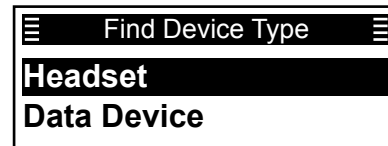

Pairing with a headset or a data device

Step 4: Connect to the device (Transceiver)

- 1. Push [P2 (Up)] or [P1 (Down)] to select the headset to connect, then push [OK].
 - Connects to the headset.

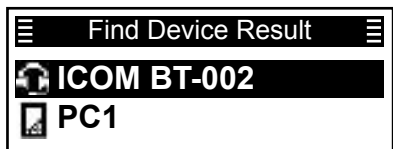

- ① If the Serial Port Access Authorization screen is displayed when using a PC, accept it. See the device's instruction manual for details.
- After the transceiver and the device connection has succeeded, "✓" is displayed beside the device's icon.



- 2. Hold down [Back] for 1 second to return to the standby screen.
 - While connected to a Bluetooth device, "Ⓜ" is displayed instead of "✱."

NOTE: The transceiver connects to the last connected device, if the connecting operation is performed on the device side, even if **Auto Connect** is set to "OFF."
(Menu > Bluetooth > **Auto Connect**)

TIP: When **Auto Connect** is set to "ON," the transceiver automatically connects to the last paired device after you turn ON the transceiver. After connecting, "Ⓜ" is displayed instead of "✱."

Headset settings

◇ AF Output

(Menu > Bluetooth > **Audio Select**)

You can set the audio output device when a Bluetooth headset is connected.

If **Audio Select** is set to “RMT & SP,” you can hear audio from both a connected Bluetooth headset and the transceiver’s speaker.

See page 6-13 for details.

◇ About the VS-3 headset

You can set the detailed settings of the optional VS-3 Bluetooth® HEADSET.

- **Key Beep** (p. 6-13)

(Menu > Bluetooth > **Key Bp (VS3)**)

Set a beep to sound when you push [PLAY], [FWD] or [RWD] on the VS-3. This setting is different from the transceiver’s beep setting. When both settings are set to “ON,” the beeps sound on the transceiver and the headset.

- **Power Save** (p. 6-13)

(Menu > Bluetooth > **PWR Sv (VS3)**)

The Power Save function temporarily disconnects the Bluetooth connection if no communication or operation is performed for 120 seconds, to prolong the VS-3’s battery life.

- **PTT Beep** (p. 6-13)

(Menu > Bluetooth > **PTT Bp (VS3)**)

Set a beep to sound when you push [PTT] on the VS-3. This setting is different from the transceiver’s beep setting. When both settings are set to “ON,” the beeps sound on the transceiver and on the headset.

- **One-touch PTT** (p. 6-13)

(Menu > Bluetooth > **1 Touch PTT**)

The One-Touch PTT function enables you to switch between transmit and receive by pushing [PTT] once.

Accepting a pairing request from a Bluetooth® device

Step 1: Prepare the Bluetooth device

Step 2: Turn ON the Bluetooth function (Transceiver)

① See page 10-3 for details.

Step 3: Enter the Waiting Pairing mode (Transceiver)

1. Push [Menu] to display the "Menu" screen.
2. Push [P2 (Up)] or [P1 (Down)] to select "Bluetooth," then push [OK].

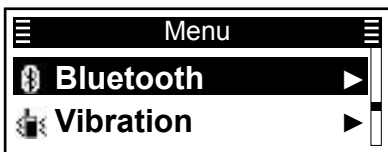

3. Push [P2 (Up)] or [P1 (Down)] to select "Wait to Pair," then push [OK].
 - Enters the Wait to Pair mode.

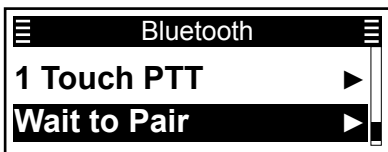

TIP: You can enter the Wait to Pair mode by pushing [Waiting Pairing].

Step 4: Enter the Pairing mode (Bluetooth device)

① See the device's instruction manual for details.

Step 5: Send a Pairing request to the transceiver (Bluetooth device)

Select the transceiver's Bluetooth unit name to send a pairing request.

- The Bluetooth device sends a pairing request.
- ① See the device's instruction manual for details.
- ② You can confirm the transceiver's Bluetooth unit name on the "Bluetooth info" screen. (p. 6-13)

Step 6: Receive a Pairing Request (Transceiver)

1. Confirm the displayed passkey is the same as yours.
2. Push [P2 (Up)] or [P1 (Down)] to select <Accept>, then push [OK].

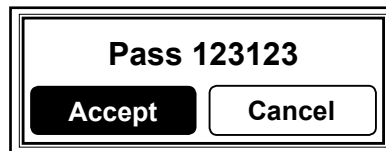

- Pairing starts.
- After the pairing is complete, the device's name is displayed in the "Device List" screen.

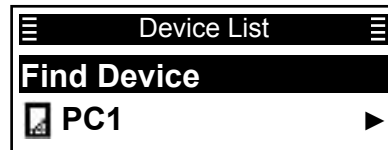

3. Push [P2 (Up)] or [P1 (Down)] to select the Bluetooth device to connect, then push [OK].



► Continued on the next page.

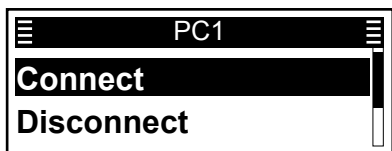

Accepting a pairing request from a Bluetooth® device

4. Push [P2 (Up)] or [P1 (Down)] to select “Connect,” then push [OK].

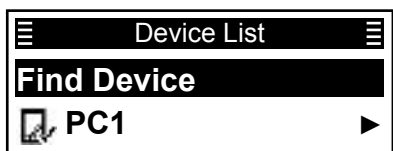

- ① If the Serial Port Access Authorization screen is displayed when using a PC, accept it. See the device's instruction manual for details.
- After the transceiver and device connection has succeeded, “✓” is displayed beside the device icon.



5. Hold down [Back] for 1 second to return to the standby screen.
- While connected to a Bluetooth headset, “” is displayed instead of “.

NOTE: When you pair with the third party's headset, entering a PIN code or passkey may be required. See the headset's instruction manual for details.

Disconnecting from a Bluetooth® device

You can disconnect from a Bluetooth device without cancelling the pairing.

(Menu > Bluetooth > **Device List**)

1. Push [Menu] to display the “Menu” screen.
2. Push [P2 (Up)] or [P1 (Down)] to select “Bluetooth,” then push [OK].

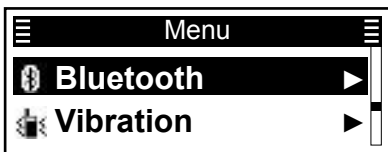

3. Push [P2 (Up)] or [P1 (Down)] to select “Device List,” then push [OK].



4. Push [P2 (Up)] or [P1 (Down)] to select the Bluetooth device that is currently connected, then push [OK].



5. Push [P2 (Up)] or [P1 (Down)] to select “Disconnect,” then push [OK].

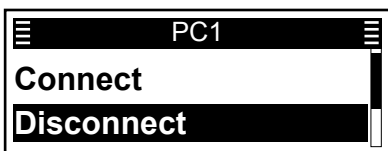

- The transceiver disconnects from the Bluetooth device, and “✓” disappears beside the device’s icon.



- ① The transceiver is still paired with the Bluetooth device.

6. Hold down [Back] for 1 second to return to the standby screen.

TIP: You can reconnect to the Bluetooth device displayed on the screen again by doing the following steps.

1. Push [P2 (Up)] or [P1 (Down)] to select the Bluetooth device to connect, then push [OK].



2. Push [P2 (Up)] or [P1 (Down)] to select “Connect,” then push [OK].

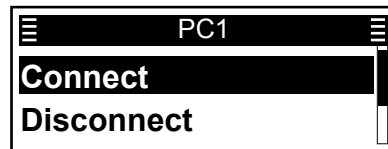

Deleting a Bluetooth® device from the pairing list

You can delete a Bluetooth device from the “Device List” screen. Before deleting a connected Bluetooth device, disconnect it. (p. 10-9)

(Menu > Bluetooth > **Device List**)

1. Push [Menu] to display the “Menu” screen.
2. Push [P2 (Up)] or [P1 (Down)] to select “Bluetooth,” then push [OK].

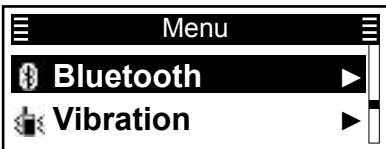

3. Push [P2 (Up)] or [P1 (Down)] to select “Device List,” then push [OK].



4. Push [P2 (Up)] or [P1 (Down)] to select the Bluetooth device that is currently unconnected, then push [OK].



5. Push [P2 (Up)] or [P1 (Down)] to select “Delete,” then push [OK].

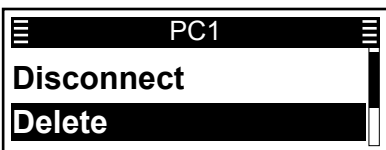

• The Bluetooth device is deleted from the list.

NOTE: If you want to connect the deleted device, you must first pair with it again. (p. 10-4)

Resetting the installed Bluetooth® unit

You can reset the installed Bluetooth unit. You should reset the unit if you have some troubles during Bluetooth operation.

NOTE: Before resetting, the Bluetooth function must be turned OFF. Otherwise, resetting cannot be done.

(Menu > Bluetooth > **Bluetooth Reset**)

1. Push [Menu] to display the “Menu” screen.
2. Push [P2 (Up)] or [P1 (Down)] to select “Bluetooth,” then push [OK].

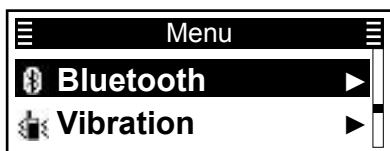

3. Push [P2 (Up)] or [P1 (Down)] to select “Bluetooth Reset,” then push [OK].

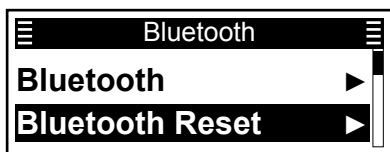

4. Push [P2 (Up)] or [P1 (Down)] to select <OK>, then push [OK].



• Resets the Bluetooth unit's settings to their factory defaults.

5. Hold down [Back] for 1 second to return to the standby screen.

The maximum number of paired devices

You can pair two types of the Bluetooth devices:
Headset and Data devices.

Up to 8 Bluetooth devices can be paired.

Section 11 OTHERS

Displaying the transceiver's firmware information	11-2
LCD Check	11-3
Copying data from a transceiver	11-4
◇ Connecting.....	11-4
◇ Copying data.....	11-4

Displaying the transceiver's firmware information

You can display the transceiver firmware's information.

(Menu > Information > **Firmware Info**)

1. Push [Menu] to display the Menu screen.
2. Push [P2 (Up)] or [P1 (Down)] to select "Information," then push [OK].

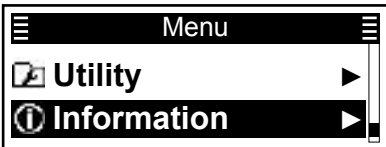

3. Push [P2 (Up)] or [P1 (Down)] to select "Firmware Info," then push [OK].

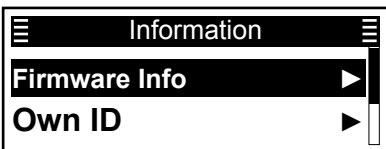

4. Push [P2 (Up)] or [P1 (Down)] to display the transceiver's firmware information. (The content below is an example.)

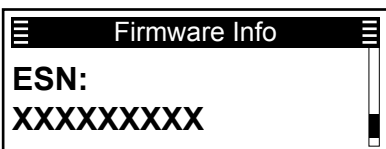
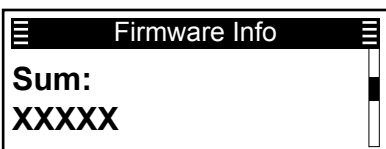
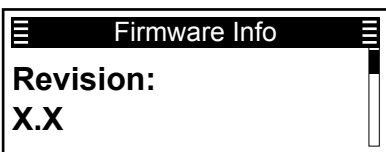

5. Hold down [Back] for 1 second to return to the standby screen.

LCD Check

You can check whether or not the LCD displays correctly.

(Menu > Display > **LCD Test**)

1. Push [Menu] to display the Menu screen.
2. Push [P2 (Up)] or [P1 (Down)] to select “Display,” then push [OK].

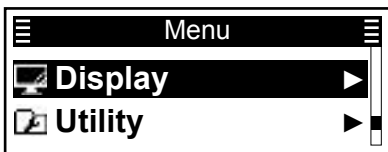

3. Push [P2 (Up)] or [P1 (Down)] to select “LCD Test,” then push [OK].



- The transceiver displays the Test screen.
- ① If the LCD displays correctly, the screen is all black, as shown below.



4. Hold down [Back] for 1 second to return to the standby screen.

Copying data from a transceiver

This section describes how to copy data from a Master transceiver to a Sub transceiver using the optional OPC-1870 ZONE COPY CABLE.

NOTE: Before copying, set **Transceiver Data Out** to "ON" using the CS-F52D PROGRAMMING SOFTWARE. (Common > Security Setting > Security)

◇ Connecting

Before copying, connect the Master and Sub transceivers using the optional OPC-1870.

1. Turn OFF the Master and Sub transceivers.
2. Connect the two transceivers with the cable.

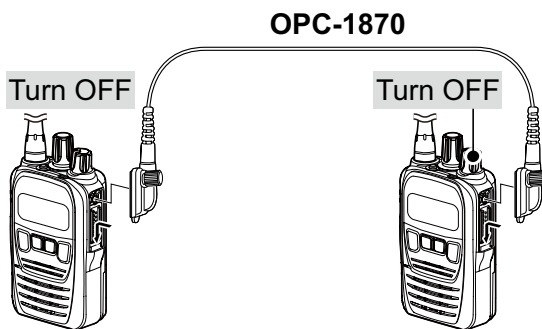

◇ Copying data

Step 1: Entering the Programming mode (Master)

While holding down [P1] and [F2], turn ON the transceiver. Continue holding down [P1] and [F2] for about 3 seconds.

- "Programming" is displayed and the transceiver enters the Programming mode.

Step 2: Turning ON the transceiver (Sub)

Step 3: Copying data (Master)

Push [PTT] on the Master transceiver to start copying data to the Sub transceiver.

Step 4: Complete (Master/Sub)

After copying is completed, the Master and Sub transceivers automatically restart.

- The user can operate the Sub transceiver with the loaded data.

Section 12 OPTIONS

HM-222 SPEAKER MICROPHONE	12-2
◇ Attaching	12-2
MB-136 BELT CLIP	12-3
◇ MB-136 contents	12-3
◇ Attaching	12-3
◇ Detaching	12-4

HM-222 SPEAKER MICROPHONE

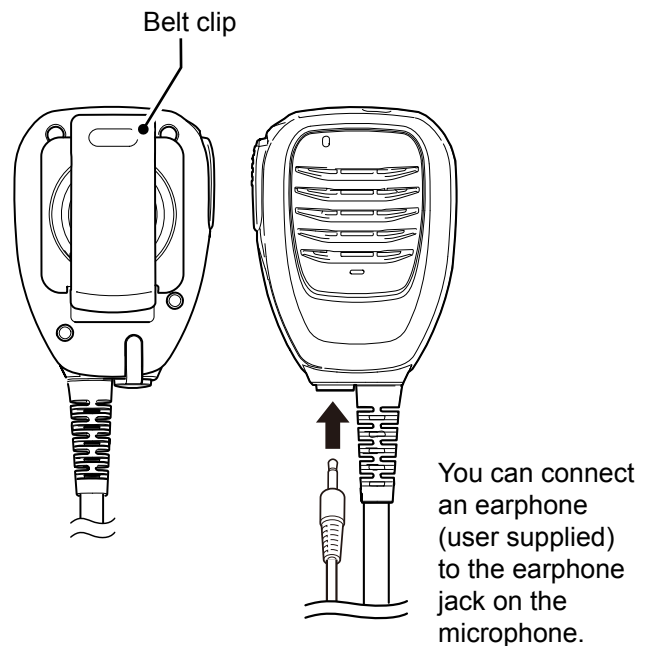
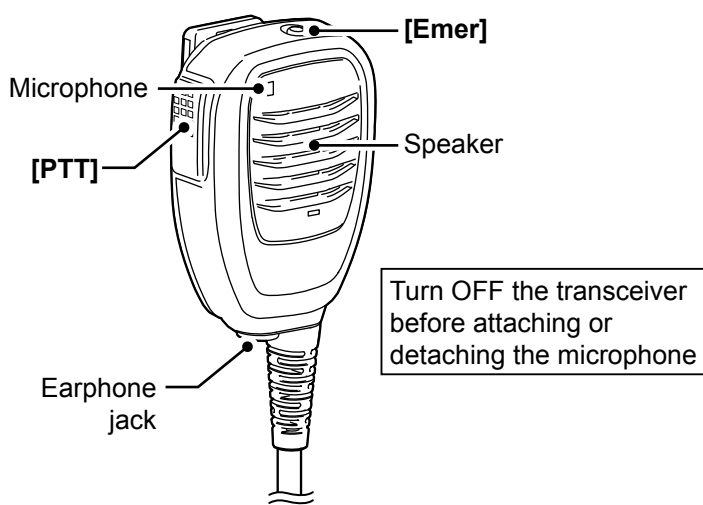

NOTE:

- **NEVER** immerse the connector in water. If the connector becomes wet, **BE SURE** to dry it before attaching to the transceiver.
- The microphone element is located at the top left of the speaker microphone, as shown in the illustration above. To maximize the readability of your transmitted audio, hold the microphone approximately 5 to 10 cm (2 to 4 inches) from your mouth, and then speak at your normal voice level.

◆ Attaching

Attach the connector of the speaker microphone to the multi connector on the transceiver and tighten the screw.

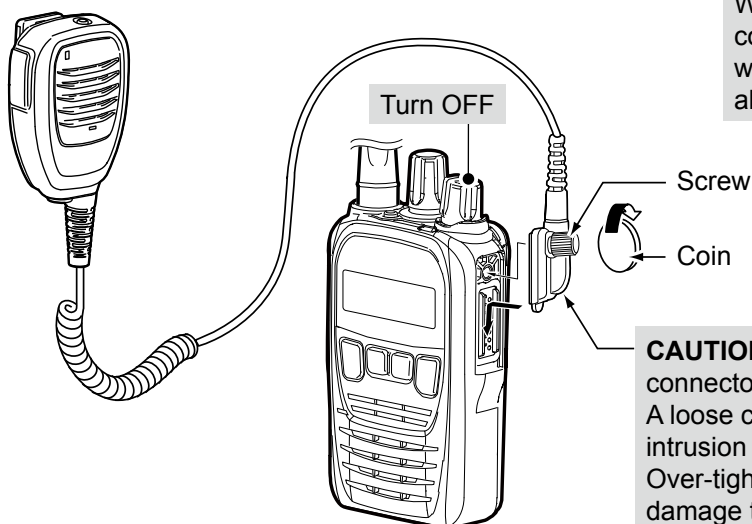

NOTE: KEEP the connector cover attached to the transceiver when the speaker microphone is not in use.

Water will not get into the transceiver, even if the cover is not attached. However, the terminals (pins) will become rusty, or the transceiver will function abnormally if the connector becomes wet.

MB-136 BELT CLIP

◇ MB-136 contents

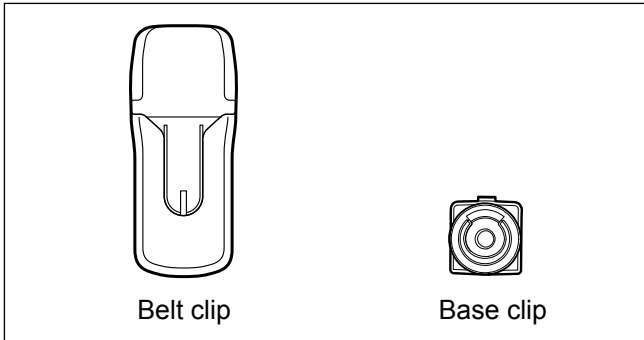

◇ Attaching

1. Detach the battery pack, if attached. (p. 1-3)
2. Slide the base clip in the direction of the arrow until the clip locks and makes a "click" sound.
3. Attach the battery pack to the transceiver. (p. 1-3)

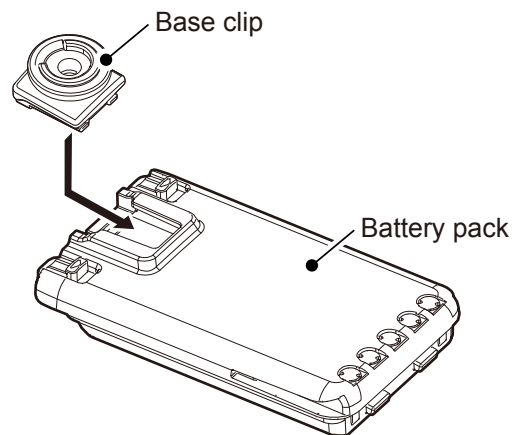

4. Clip the belt clip on your belt.
5. Insert the transceiver upsidedown into the belt clip until the base clip is fully inserted in the groove.

NOTE: Hold the transceiver firmly when inserting the transceiver into the belt clip.

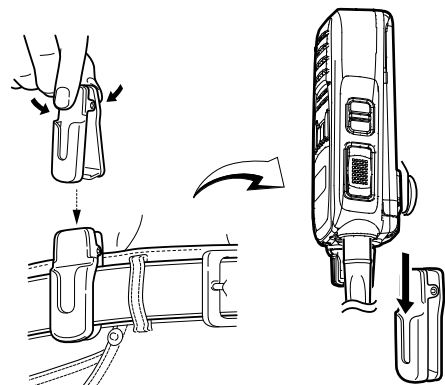

6. Once the transceiver is locked in place, it swivels, as shown to the right.

NOTE: If the transceiver has been accidentally dropped and the base clip is scratched or damaged, the transceiver may not be properly attached to the holder or swivel.

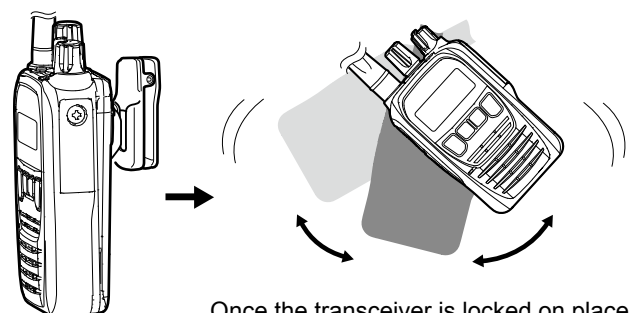

Once the transceiver is locked on place, it swivels 360 degrees.

MB-136 BELT CLIP

◇ Detaching

1. Turn the transceiver upsidedown in the direction of the arrow and pull it out of the belt clip.

NOTE: Hold the transceiver firmly when removing the transceiver from the belt clip.

2. Detach the battery pack. (p. 1-3)

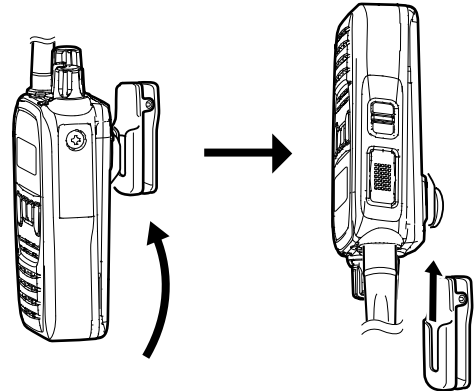

3. Lift up the tab on the base clip (❶), and then slide the clip in the direction of the arrow (❷).

BE CAREFUL! Do not break your fingernail.

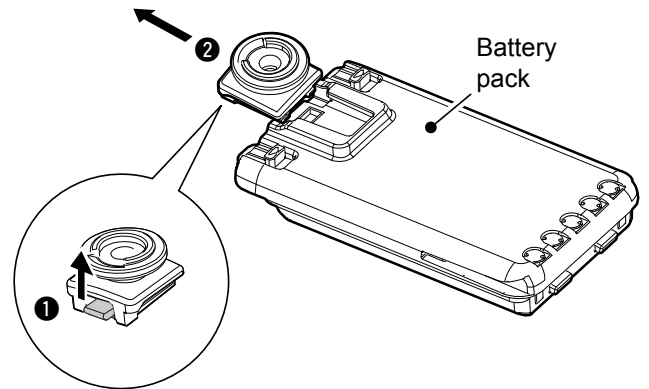

Count on us!

