



INSTRUCTION MANUAL

HF/50 MHz ALL BAND 1 kW LINEAR AMPLIFIER **IC-PW2**



This device complies with part 15 of the FCC rules. Operation is subject to the following two conditions: (1) This device may not cause harmful interference, and (2) this device must accept any interference received, including interference that may cause undesired operation.

Thank you for choosing this Icom product. The IC-PW2 is an HF/50 MHz all band linear amplifier that achieves 1 kW full power and full duty specifications by employing LDMOS power transistors in the RF power amplifier circuit, which is known for its reliability in high-temperature environments due to continuous transmission. With proper care, this product should provide you with years of trouble-free operation.

IMPORTANT

READ ALL INSTRUCTIONS carefully and completely before using the linear amplifier.

SAVE THIS INSTRUCTION MANUAL— This instruction manual contains important operating instructions for the IC-PW2.

FEATURES

- **1 kW full power and full duty cycle operation**
LDMOS power transistors are used in the RF power amplifier circuit
- **A high-efficiency power supply unit**
- **Detachable controller with a 4.3 inch touch screen color display**
- **A relay-type automatic antenna tuner that covers the same matching range from the HF band to the 50 MHz band**
- **An auto antenna selector that can switch between 6 antennas in synchronization with the frequency band of 2 excitors**
- **Connectors for external units, such as a preamplifier and a band-pass filter**
- **Supports simultaneous output of band signal on 2 systems**
- **The Display function during protection operation**
- **Operation with excitors of up to 200 W output power**
- **Supports the Single Operator Two Radios (SO2R) operation**
- **Transmitter Lockout function to prevent simultaneous transmission from 2 excitors**
- **An SD card slot for saving settings and updating firmware**
- **REMOTE AUX jack used for antenna control, and so on**
- **The Digital Pre-Distortion (DPD) function for increased linearity and clean transmission**
- **A LAN port for remote control operation from a PC (Future function, as of January 2025)**

SUPPLIED ACCESSORIES

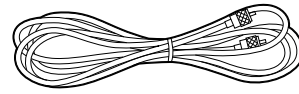

OPC-125B COAXIAL CABLE
(Approximately 3 m,
9.8 feet)

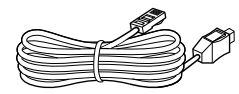

Controller cable
(Approximately 3 m,
9.8 feet)

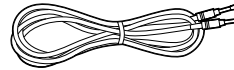

OPC-718
REMOTE CONTROL CABLE
(Approximately 3 m,
9.8 feet)

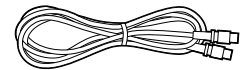

OPC-104B
ACCESSORY CABLE
(Approximately 3 m,
9.8 feet)

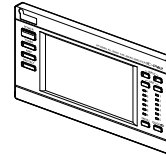

Controller



Dummy panel



Grounding lug

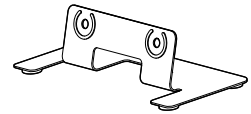

Mounting bracket stand

Information

- Some accessories are not supplied, or the shape is different, depending on the linear amplifier version.
- Use an AC power plug that matches the shape of the outlet to be used, because the plug is not included.
- To connect a second Icom exciter, use the optional OPK-5 (p. 11-1).
- Icom does not provide support for non-Icom excitors, PC, network equipment, or network settings connected to the amplifier.

EXPLICIT DEFINITIONS

WORD	DEFINITION
⚠ DANGER!	Personal death, serious injury or an explosion may occur.
⚠ WARNING!	Personal injury, fire hazard or electric shock may occur.
CAUTION	Equipment damage may occur.
NOTE	Recommended for optimum use. No risk of personal injury, fire or electric shock.

ABOUT CE AND DOC

CE Hereby, Icom Inc. declares that the versions of IC-PW2 which have the “CE” symbol on the product, comply with the essential requirements of the Radio Equipment Directive, 2014/53/EU, and the restriction of the use of certain hazardous substances in electrical and electronic equipment Directive, 2011/65/EU. The full text of the EU declaration of conformity is available at the following internet address:
<https://www.icomjapan.com/support/>

These versions also comply with the essential requirements of the Battery Regulation, (EU) 2023/1542.

DISPOSAL



The crossed-out wheeled-bin symbol on your product, literature, or packaging reminds you that in the European Union, all electrical and electronic products, batteries, and accumulators (rechargeable batteries)

must be taken to designated collection locations at the end of their working life. Do not dispose of these products as unsorted municipal waste. Dispose of them according to the laws in your area.

ABOUT UKCA DOC

To obtain the UKCA Declaration of Conformity, please contact Icom UK Limited by email at info@icomuk.co.uk or alternatively call + 44(0) 1227 741741.

ABOUT SPURIOUS SIGNALS

Spurious signals may be received in some frequencies. These are made in the internal circuit and do not indicate a linear amplifier malfunction.

FCC INFORMATION

This equipment has been tested and found to comply with the limits for a Class B digital device, pursuant to part 15 of the FCC Rules. These limits are designed to provide reasonable protection against harmful interference in a residential installation. This equipment generates, uses, and can radiate radio frequency energy and, if not installed and used in accordance with the instructions, may cause harmful interference to radio communications. However, there is no guarantee that interference will not occur in a particular installation. If this equipment does cause harmful interference to radio or television reception, which can be determined by turning the equipment off and on, the user is encouraged to try to correct the interference by one or more of the following measures:

- Reorient or relocate the receiving antenna.
- Increase the separation between the equipment and receiver.
- Connect the equipment into an outlet on a circuit different from that to which the receiver is connected.
- Consult the dealer or an experienced radio/TV technician for help.

CAUTION: Changes or modifications to this device, not expressly approved by Icom Inc., could void your authority to operate this device under FCC regulations.

◇ FCC SDoC

This device complies with part 15 of the FCC Rules. Operation is subject to the condition that this device does not cause harmful interference

Responsible Party

Company Name: Icom America Inc.
Address: 12421 Willows Road NE Kirkland, WA 98034

U.S. Contact Information

800-USA-ICOM (800-872-4266)
Monday – Friday 7 AM to 5 PM PST

Icom is not responsible for the destruction, damage to, or performance of any Icom or non-Icom equipment, if the malfunction is because of:

- Force majeure, including, but not limited to, fires, earthquakes, storms, floods, lightning, or other natural disasters, disturbances, riots, war, or radioactive contamination.
- The use of Icom linear amplifiers with any equipment that is not manufactured or approved by Icom.

ABOUT THE TOUCH SCREEN

◇ Touch operation

In this instruction manual, the touch operation is described as shown below, with the beep tone ON.



Touch

If the display is touched briefly, one short beep sounds.



Touch for 1 second

If the display is touched for 1 second, one short and one long beep sound.

◇ Touch screen precautions

- The touch screen may not properly work when the LCD protection film or sheet is attached.
- Touching the screen with your fingernails, sharp-tipped objects, and so on, or touching the screen hard may damage it.
- Tablet PC operations such as flick, pinch in, and pinch out cannot be performed on this touch screen.

◇ Touch screen maintenance

- If the touch screen becomes dusty or dirty, wipe it clean with a soft, dry cloth.
- When you wipe the touch screen, be careful not to push it too hard or scratch it with your fingernails. Otherwise, you may damage the screen.

ABOUT THE MANUALS

The following manuals or Guide for this linear amplifier are published at the following Internet address:
<https://www.icomjapan.com/support/>

• **Instruction Manual**

Instructions for full operations, the same as this manual.

• **CI-V Reference Guide (English)**

Describes the control commands used in remote control operation (serial communication with CI-V).

For Reference

• **HAM Radio Terms (English)**

A glossary of HAM radio terms in English.

To read the manuals or Guide, Adobe® Acrobat® Reader® is required. If you have not installed it, please download the Adobe® Acrobat® Reader® and install it to your PC. You can download it from Adobe Systems Incorporated's website.

TRADEMARKS

Icom and the Icom logo are registered trademarks of Icom Incorporated (Japan) in Japan, the United States, the United Kingdom, Germany, France, Spain, Russia, Australia, New Zealand and/or other countries. All other products or brands are registered trademarks or trademarks of their respective holders.

This product includes RTOS "RTX" software, and is licensed according to the software license.

This product includes "zlib" open source software, and is licensed according to the open source software license.

This product includes "libpng" open source software, and is licensed according to the open source software license.

Refer to the "ABOUT THE LICENSES" page at the end of this manual for information on the open source software being used in this product.

ABOUT THE INSTRUCTIONS

The instruction manual uses the following indicators.

“ ” (Quotation marks):

Used to indicate icons, setting items, and screen titles displayed on the screen.

The screen titles are also written in uppercase letters. (Example: FUNCTION screen)

[] (brackets):

Used to indicate keys.

Routes to the Set modes and Setting screens:

Routes to the Set mode, Setting screens, and the setting items are in the following manner.

MENU » SET > Time Set > **Date/Time**

Instruction example:

◇ **Setting the date**

1. Display the DATE/TIME screen.
MENU » SET > Time Set > **Date/Time**
2. Touch “Date.”
 - Displays the date editing screen.
3. Touch [+] or [-] to set the date.
4. Touch [SET] to set the date.

Detailed instruction:

1. Push [MENU].

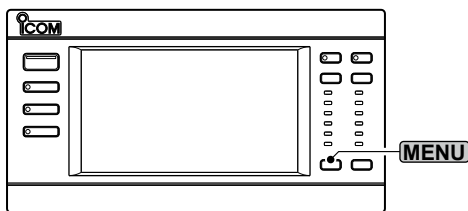

- Opens the MENU screen.

2. Touch [SET].



- Opens the SET screen.

3. Touch “Time Set.”

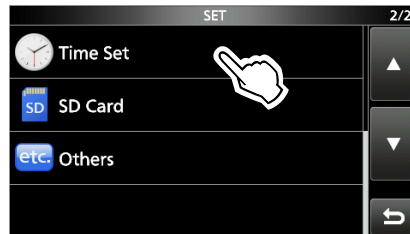

- Opens the TIME SET screen.

- ① Push [▲] or [▼] to scroll through the items.

4. Touch “Date/Time.”

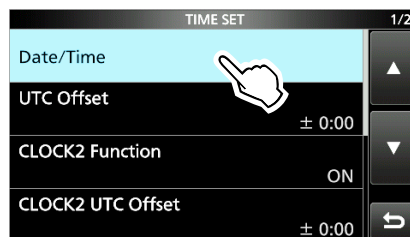

- Opens the DATE/TIME screen.

5. Touch “Date.”

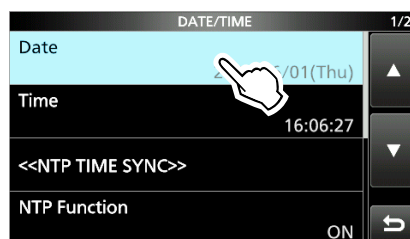

- Opens the Date screen.

6. Touch [+] or [-] to set the date.

7. Touch [SET] to set the date.

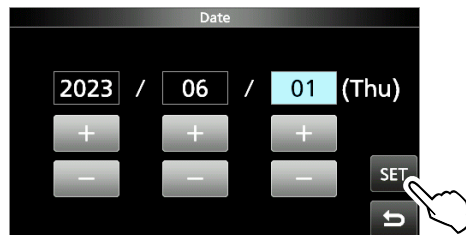

INSTALLATION NOTES

For amateur base station installations it is recommended that the forwards clearance in front of the antenna array is calculated relative to the EIRP (Effective Isotropic Radiated Power). The clearance height below the antenna array can be determined in most cases from the RF power at the antenna input terminals.

As different exposure limits have been recommended for different frequencies, a relative table shows a guideline for installation considerations.

Below 30 MHz, the recommended limits are specified in terms of V/m or A/m fields as they are likely to fall within the near-field region. Similarly, the antennas may be physically short in terms of electrical length and that the installation will require some antenna matching device which can create local, high intensity magnetic fields. Analysis of such MF installations is best considered in association with published guidance notes such as the FCC OET Bulletin 65 Edition 97-01 and its annexes relative to amateur transmitter installations.

The EC recommended limits are almost identical to the FCC specified 'uncontrolled' limits and tables exist that show pre-calculated safe distances for different antenna types for different frequency bands. Further information can be found at <https://www.arrl.org/>.

• Typical amateur radio installation

Exposure distance assumes that the predominant radiation pattern is forwards and that radiation vertically downwards is at unity gain (sidelobe suppression is equal to main lobe gain). This is true of almost every gain antenna today. Exposed persons are assumed to be beneath the antenna array and have a typical height of 1.8 m.

The figures assume the worst case emission of constant carrier.

For the bands 10 MHz and higher the following power density limits have been recommended:

10–144 MHz 2 W/sq m

EIRP clearance heights by frequency band:

1 Watts	2.1 m
10 Watts	2.8 m
25 Watts	3.4 m
100 Watts	5 m
1000 Watts	12 m

Forward clearance, EIRP by frequency band:

100 Watts	2 m
1000 Watts	6.5 m
10,000 Watts	20 m
100,000 Watts	65 m

In all cases any possible risk depends on the transmitter being activated for long periods. (actual recommendation limits are specified as an average during 6 minutes) Normally the transmitter is not active for long periods of time. Some radio licenses will require that a timer circuit automatically cuts the transmitter after 1–2 minutes etc.

Similarly some types of emission, i.e., SSB, CW, AM etc. have a lower 'average' output power and the assessed risk is even lower.

PRECAUTIONS

⚠ **DANGER HIGH RF VOLTAGE! NEVER** touch an antenna or antenna connector while transmitting or tuning. This could cause an electrical shock or burn.

⚠ **DANGER! NEVER** operate the linear amplifier near unshielded electrical blasting caps or in an explosive atmosphere. This could cause an explosion and death.

⚠ **WARNING! NEVER** use the linear amplifier during a lightning storm. It may result in an electric shock, cause a fire or damage the amplifier. Always disconnect the power cable and antenna before a storm.

⚠ **WARNING! NEVER** operate the linear amplifier if you notice an abnormal odor, sound, or smoke.

⚠ Immediately turn OFF the power and remove the power cable. Contact your Icom dealer or distributor for advice.

⚠ **WARNING! NEVER** touch the linear amplifier with wet hands. This may result in an electrical shock or damage the amplifier.

⚠ **WARNING! NEVER** let metal, wire, or other objects contact the linear amplifier inside or make incorrect contact with connectors on the rear panel. This could cause an electric shock or damage the amplifier.

⚠ **WARNING! NEVER** operate the linear amplifier without solid ground. Always connect the ground wire to the ground terminal.

⚠ **WARNING! NEVER** put the linear amplifier on an unstable place where it may suddenly move or fall. This could cause an injury or damage the amplifier.

CAUTION: The linear amplifier weighs approximately 21.6 kg (47.6 lb). Always have 2 people carry, lift or turn over the amplifier.

CAUTION: DO NOT expose the linear amplifier to rain, snow, or any liquids. They could damage the amplifier.

CAUTION: DO NOT use or leave the linear amplifier in excessively dusty environments. This could damage the amplifier.

CAUTION: DO NOT install or place the linear amplifier in a place without adequate ventilation or block any cooling vents on the top, rear, sides, or bottom of the amplifier. Heat dissipation may be reduced and damage the amplifier.

CAUTION: DO NOT use harsh solvents such as Benzine or alcohol to clean the linear amplifier, as they can damage the amplifier's surfaces. If the amplifier becomes dusty or dirty, wipe it clean with a dry, soft cloth.

CAUTION: DO NOT set the connected exciter's (transceiver's) RF output power to more than the linear amplifier's maximum input level (200 W). Otherwise, the amplifier will be damaged.

CAUTION: DO NOT change the internal settings of the amplifier. This may reduce its performance and/or cause extensive and expensive damage to the amplifier. The amplifier warranty does not cover any problems caused by unauthorized internal adjustments.

NEVER place the linear amplifier in an insecure place to avoid inadvertent use by unauthorized persons.

BE CAREFUL! The linear amplifier may become hot after continuously transmitting for a long period of time.

NOTE: DO NOT use or leave the linear amplifier in areas with temperatures below -10°C ($+14^{\circ}\text{F}$) or above $+40^{\circ}\text{C}$ ($+104^{\circ}\text{F}$).

NOTE: During maritime mobile operation, keep the linear amplifier as far away as possible from the magnetic navigation compass to prevent erroneous indications.

Turn OFF the linear amplifier's power and disconnect the power cable when you will not use the amplifier for a long period of time.

The LCD display may have cosmetic imperfections that appear as small dark or light spots. This is not a malfunction or defect, but a normal characteristic of LCD displays.

◇ Coin cell battery cautions

⚠ **DANGER!** The linear amplifier contains a coin cell battery. **NEVER** swallow the battery.

This could cause severe internal burns in just 2 hours, and could lead to death.

Keep new and used batteries away from children.

Also, **DO NOT** use or leave the linear amplifier open. It must be away from children.

If the battery might have been swallowed or placed inside any part of the body, immediately go to the doctor.

⚠ **WARNING! NEVER** charge, short-circuit, disassemble, deform, heat, or incinerate the coin cell battery. The internal flammable materials may cause them to overheat, explode, or catch fire.

⚠ **WARNING! NEVER** solder the coin cell battery terminals. This may cause them to overheat, explode, or catch fire.

⚠ **WARNING!** When disposing of batteries, wrap the terminals in tape to insulate them. Shorting may occur if the terminals touch metal objects. This could cause them to overheat, explode, or catch fire.

Dispose of used batteries in accordance with local regulations.

⚠ **WARNING! NEVER** reverse the coin cell battery polarity. This could cause a fire or damage the linear amplifier.

⚠ **WARNING! NEVER** leave the coin cell battery in places with direct sunlight, high temperature, or high humidity. This could cause a fire.

Coin cell battery manufacturer:

Name: Panasonic Energy Co., Ltd

Address: 1-1 Matsushita-cho, Moriguchi City, Osaka
570-8511, Japan

TABLE OF CONTENTS

IMPORTANT	i	Connecting to exciters	2-4
FEATURES	i	◇ Connecting 2 Icom exciters to [INPUT 1] and [INPUT 2]	2-5
SUPPLIED ACCESSORIES	i	◇ Connecting 1 Icom exciter to [INPUT 1]	2-5
EXPLICIT DEFINITIONS	ii	◇ Connecting 1 Icom exciter to [INPUT 2]	2-6
ABOUT CE AND DOC	ii	◇ Connecting 1 Icom exciter to [INPUT 1] and [INPUT 2]	2-6
DISPOSAL	ii	◇ Connecting 1 Icom and 1 non-Icom exciter to [INPUT 1] and [INPUT 2]	2-7
ABOUT UKCA DOC	ii	◇ Connecting 1 non-Icom exciter to [INPUT 1] ..	2-7
ABOUT SPURIOUS SIGNALS	ii	◇ Connecting 2 non-Icom exciters to [INPUT 1] and [INPUT 2]	2-8
FCC INFORMATION	ii		
◇ FCC SDoC	ii	3 INITIAL SETUP	3-1
ABOUT THE TOUCH SCREEN	iii	Before initial setup	3-1
◇ Touch operation	iii	CI-V settings	3-1
◇ Touch screen precautions	iii	◇ CI-V address	3-1
◇ Touch screen maintenance	iii	◇ CI-V baud rate	3-1
ABOUT THE MANUALS	iii	◇ CI-V Transceive function	3-1
TRADEMARKS	iii	Turning power ON or OFF	3-1
ABOUT THE INSTRUCTIONS	iv	Connection mode	3-1
INSTALLATION NOTES	v	◇ Setting the exciter connection	3-1
PRECAUTIONS	vi	◇ Switching the display layout of [INPUT 1] and [INPUT 2]	3-2
◇ Coin cell battery cautions	vi	◇ The CI-V settings of [INPUT 1] and [INPUT 2] ..	3-2
		◇ Synchronization with the exciter	3-3
1 PANEL DESCRIPTION	1-1	ALC adjustment	3-3
Front panel	1-1	4 BASIC OPERATION	4-1
Rear panel	1-2	Operation modes	4-1
Touch screen display	1-4	◇ Antenna Selector mode	4-1
◇ MENU screen	1-6	◇ Antenna Tuner mode	4-1
◇ QUICK MENU screen	1-6	◇ Linear Amplifier mode	4-1
Keyboard entering and editing	1-6	Changing the status of [INPUT 1] and [INPUT 2] ..	4-2
◇ Entering and editing characters	1-6	◇ Using the RF input selector	4-2
◇ Keyboard types	1-7	◇ Using the touch screen display	4-2
◇ Entering and editing	1-7	Switching the maximum output power	4-2
◇ Entering and editing example	1-8	Selecting the frequency band	4-2
2 INSTALLATION AND CONNECTIONS	2-1	Selecting the antenna connector	4-3
Attaching the controller	2-1	◇ Using the antenna selector	4-3
Using the controller separately from the main unit	2-1	◇ Using the touch screen display	4-3
◇ Detaching from the main unit	2-1	ANT key display settings	4-4
◇ Connecting the controller cable	2-2	Antenna memory	4-4
◇ Attaching the mounting bracket stand	2-2	RX-I/O setting	4-5
◇ Attaching to a flat surface	2-2	Meter display	4-6
Select a location	2-2	◇ Displaying the Multi-function meter	4-6
Heat dissipation	2-2	◇ About the HOT zone of the TEMP meter	4-6
Grounding	2-2	Confirmation before transmitting	4-6
Connecting the AC power cable	2-3	5 ANTENNA TUNER OPERATION	5-1
◇ About the power supply voltage	2-3	About the internal antenna tuner	5-1
◇ About an AC power plug	2-3	About manual tuning	5-1
Exciter	2-3		
Antenna	2-4		
◇ Impedance	2-4		
◇ About the maximum input power	2-4		

6	SD CARD	6-1	10	UPDATING THE FIRMWARE	10-1
	About the SD cards	6-1		General.....	10-1
	Saving data	6-1		◇ About updating the firmware	10-1
	Inserting.....	6-1		◇ Checking the firmware version.....	10-1
	Formatting	6-1		◇ Preparation.....	10-2
	Unmounting	6-2		◇ Unzipping the firmware folder.....	10-2
	Saving the setting data.....	6-2		Updating the firmware	10-3
	Loading the saved data.....	6-3	11	SPECIFICATIONS AND OPTIONS	11-1
	Deleting a data file.....	6-4		Specifications	11-1
	Displaying the SD card information	6-4		◇ General.....	11-1
	About the SD card's folders.....	6-5		◇ Antenna tuner.....	11-1
7	SET MODE	7-1		Options	11-1
	Set mode description.....	7-1	12	CONNECTOR INFORMATION	12-1
	Function.....	7-2		[INPUT 1]/[INPUT 2].....	12-1
	Connectors	7-2		[RX-ANT IN]/[RX-ANT OUT].....	12-1
	Network	7-4		[INPUT 1/2].....	12-1
	Display.....	7-4		[LAN]	12-1
	Time Set	7-6		[REMOTE AUX].....	12-1
	SD Card.....	7-6		[ANT 1] to [ANT 6].....	12-1
	Others.....	7-7		[ACC 1]/[ACC 2]	12-2
8	OTHER FUNCTIONS	8-1		[REMOTE 1]/[REMOTE 2].....	12-2
	Protection function.....	8-1		[SEND 1]/[SEND 2]	12-2
	◇ About the cooling fan.....	8-1		[ALC 1]/[ALC 2]	12-2
	◇ Types of the Protection function	8-1		[BAND 1]/[BAND 2]	12-2
	Clock and timers.....	8-2		ABOUT THE LICENSES	I
	◇ Setting the date	8-2			
	◇ Setting the current time	8-2			
	NTP function.....	8-3			
	◇ Using the NTP Time Synchronize function....	8-3			
	◇ Using the NTP function	8-3			
	Screen Capture function.....	8-3			
	◇ Setting the Screen Capture function	8-3			
	◇ Capturing a screen.....	8-3			
	◇ Viewing the captured screen	8-3			
	Displaying my call sign	8-4			
	Digital Pre-Distortion (DPD) function.....	8-4			
	◇ Connecting with the Icom exciter	8-4			
	◇ The DPD adjustment and operation	8-4			
9	MAINTENANCE	9-1			
	Resetting	9-1			
	◇ Partial reset	9-1			
	◇ All reset	9-1			
	Touch screen calibration function	9-2			
	Cleaning	9-2			
	Clock backup battery replacement.....	9-3			
	Troubleshooting.....	9-4			

Front panel

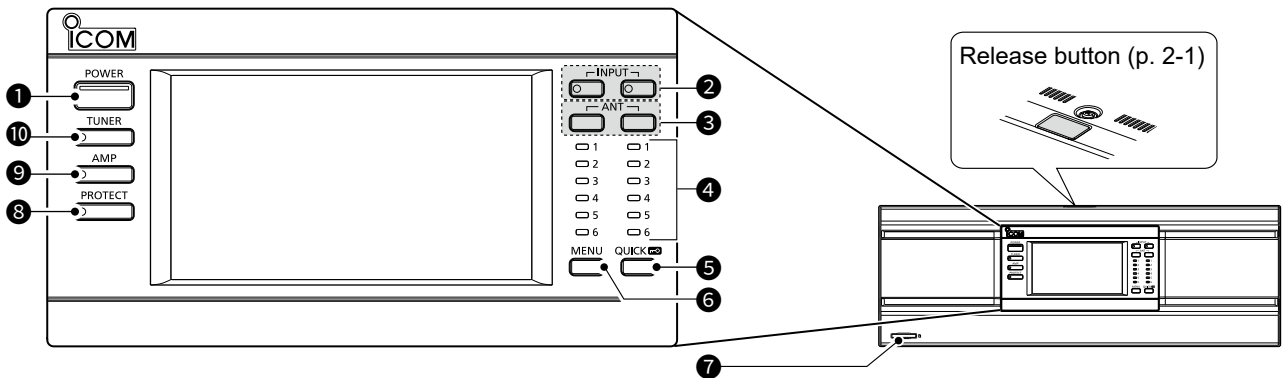

1 POWER KEY **POWER** (pp. 3-1, 4-1)

Push to turn the linear amplifier ON or OFF.

- ① When the amplifier is turned ON, the indicator lights blue.
- ① When the amplifier is turned OFF, and the Icom exciter is turned ON, the amplifier operates in the Antenna Selector mode (The LCD display, the linear amplifier circuit, and the internal antenna tuner are OFF).

2 RF INPUT SELECTOR **INPUT** (pp. 3-1, 4-2)

When "Connect Two Exciters to INPUT1 & 2" is selected in the "Exciter Connection" setting (p. 3-1), push either key to change the status of [INPUT 1] and [INPUT 2], as shown below.

INPUT 1/2 indicator	Status
OFF	OFF (No operation is performed)
Lights Orange	TX/RX side (TX and RX)
Lights Green	RX side (RX only)

① Information

- The status of [INPUT 1] and [INPUT 2] can be changed, even in the Antenna Selector mode.
- When another option is selected in the "Exciter Connection" setting, this key cannot be used.
- When "Connect an Exciter to INPUT1 & 2" is selected in the "Exciter Connection" setting, the indicator status differs, depending on the Icom exciter's Split function setting.

The Split function is turned ON:

The [INPUT 1] indicator will be OFF.

The Split function is turned OFF:

The [INPUT 2] indicator will be OFF.

3 ANTENNA SELECTOR **ANT** (p. 4-3)

When the linear amplifier is turned OFF:

- Push to change the antenna connector alternately between ANT 1 and ANT 6.

When the linear amplifier is turned ON:

- Push to display the ANTENNA SELECT (INPUT 1/INPUT 2) screen.
- Hold down for 1 second to change to the antenna connector selected in the [ANT] Switch (Hold Down) setting. (p. 4-3)
 - ① The antenna connector set to "OFF" in the ANT1 to ANT6 Settings cannot be selected.
 - ① The RX side RF input connector cannot be selected with the same antenna connector as the TX/RX side RF input connector.

4 ANTENNA INDICATOR (ANT 1 ~ ANT 6)

When the INPUT indicator is lit, the indicator of the selected antenna connector number lights white.

- ① When selecting the antenna connector by holding down **ANT** for 1 second, the indicator blinks white.

5 QUICK/LOCK KEY **QUICK**

- On the MENU screen item or its character and alphanumeric editing screen, push the key to display the QUICK MENU screen. (p. 1-6)
- Hold down for 1 second to turn the Lock function ON or OFF.
 - ① When the function is turned ON, all keys except for **POWER**, **QUICK**, and **PROTECT** are disabled.

6 MENU KEY **MENU** (p. 1-6)

Push to display the MENU screen.

7 SD CARD SLOT [SD CARD] (pp. 6-1, 6-2)

Insert an SD card (User supplied).

Front panel

- 8 PROTECT SWITCH [PROTECT] (p. 8-1)**
 When the protection circuit is activated, stop transmission from the exciter and push the switch to stop the beeps and the red lighting of the indicator.
- ① The protection circuit cannot be deactivated while transmitting.
 - ① Even if the Lock function is turned ON, the protection circuit can be deactivated by pushing [PROTECT] when the exciter is not transmitting.
 - ① The function remains active until all problems are solved, even if the beeps are stopped.

- 9 LINEAR AMPLIFIER SWITCH [AMP] (p. 4-1)**
 Push to turn the linear amplifier circuit ON or OFF.
- ① When the circuit is turned ON, the indicator on [AMP] lights white.
 - ① When the circuit is turned OFF, the exciter's output power is directly output to the antenna tuner or connector.

NOTE: For only the USA version, the IC-PW2 cannot turn ON the amplifier circuit on 25.900001 ~ 27.999999 MHz.
 Due to the frequency error of the built-in frequency counter, it may not be able to turn ON even outside the above frequency range.

- 10 ANTENNA TUNER SWITCH [TUNER]**
- Push to turn the internal antenna tuner ON or OFF. (p. 4-1)
 - ① When the internal antenna tuner is ON, the indicator lights white.
 - Hold down for 1 second to start tuning. (p. 5-1)
 - ① The indicator on [TUNER] and [TUNE] blink red.

Rear panel

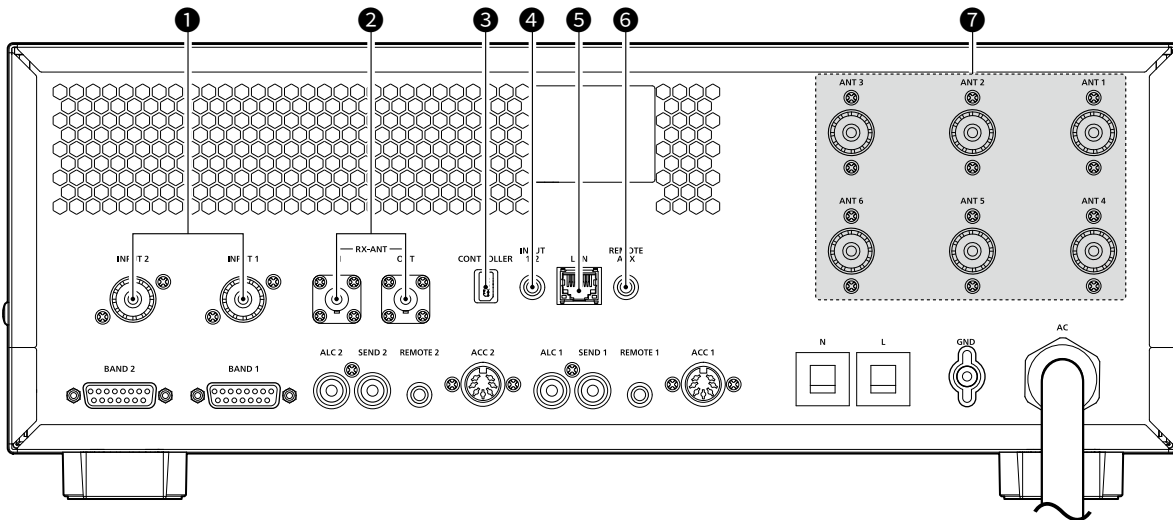

- 1 RF INPUT CONNECTORS [INPUT 1]/[INPUT 2] (p. 12-1)**
 Input an RF signal from an exciter.
- ① Connect to an antenna connector of an exciter.
 - ① To connect the second exciter, use the coaxial cable same as the supplied one.
- 2 RECEIVE ANTENNA CONNECTORS [RX-ANT IN]/[RX-ANT OUT] (p. 12-1)**
 Connect to an external unit, such as a preamplifier, a band-pass filter, or an attenuator, using BNC connectors.
- 3 CONTROLLER CONNECTOR [CONTROLLER] (p. 2-2)**
 When the controller is separated from the main unit, connects them using the supplied controller cable.

- 4 INPUT 1/2 JACK [INPUT 1/2] (p. 12-1)**
 Connects to an external device to control the operations of [INPUT 1] and [INPUT 2].
- 5 ETHERNET CONNECTOR [LAN] (p. 12-1)**
 Connects to a PC network through a LAN.
- 6 REMOTE AUX JACK [REMOTE AUX] (p. 12-1)**
 Connects to control the linear amplifier (Turning the power ON or OFF, and so on) or an external device, such as an antenna rotator controller or a band decoder, using CI-V commands.
- 7 ANTENNA CONNECTORS [ANT 1] ~ [ANT 6] (p. 12-1)**
 Connect to a 50 Ω PL-259 coax connector.

1 PANEL DESCRIPTION

Rear panel

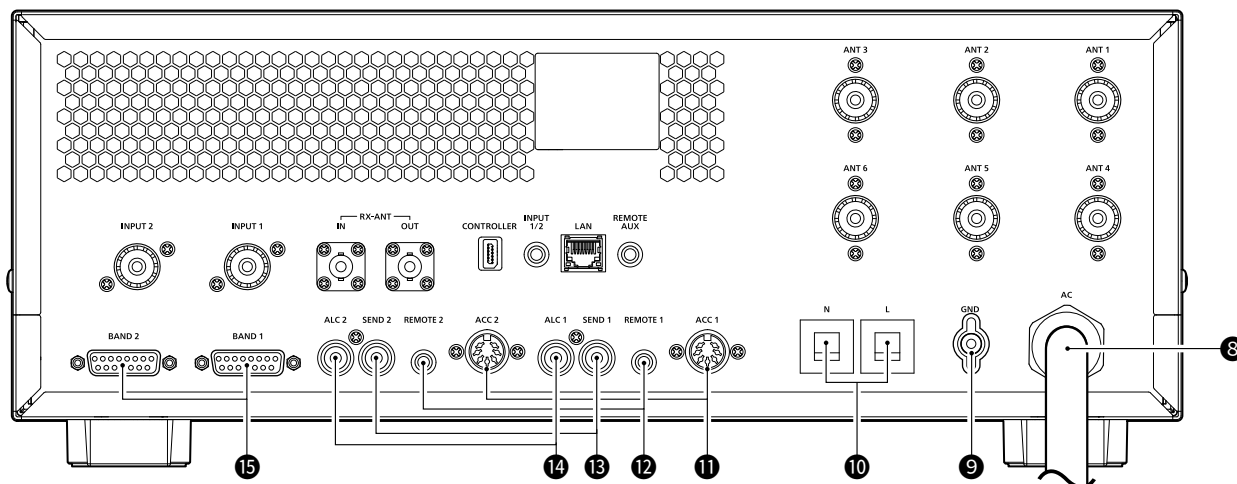

8 AC POWER SOCKET

Connects to a power supply (90 ~ 132 V or 180 ~ 264 V AC).

- ① A suitable AC power plug must be connected to each wire of the AC power cable. (p. 2-3)
- ① The EUR version can only be connected to 180 ~ 264 V AC.

9 GROUND TERMINAL (p. 2-2)

Connects to ground to prevent electrical shocks, TVI, BCI, and other problems.

10 CIRCUIT BREAKERS

Cut off the AC input when over-current occurs.

Circuit breaker capacity:

20 A (USA and EXP versions)

15 A (EUR version)

- ① To return the breaker to its original state after finding and repairing the cause of the problem, push the breakers until it makes a 'click' sound.

11 ACCESSORY SOCKETS [ACC 1]/[ACC 2] (p. 12-2)

Inputs and outputs control signals for the linear amplifier.

- ① Connect to the ACC sockets of the Icom exciter using the supplied accessory cable.
- ① To connect the second exciter, use an optional OPC-104B.

12 CI-V REMOTE CONTROL JACKS [REMOTE 1]/[REMOTE 2] (p. 12-2)

Connects to an Icom exciter to remotely control the linear amplifier using CI-V commands.

- ① To connect to the exciter, use the supplied remote control cable.
- ① To connect the second exciter, use the optional OPC-718.

NOTE: BE SURE to connect one-to-one with an Icom exciter.

The amplifier does not support remote control of multiple units using a CI-V level converter.

13 SEND CONTROL JACKS [SEND 1]/[SEND 2] (p. 12-2)

Connect to a non-Icom exciter to synchronize transmission and reception.

14 ALC OUTPUT JACKS [ALC 1]/[ALC 2] (p. 12-2)

- Connect to output the ALC voltage to a non-Icom exciter.
- When an Icom exciter is connected, and the Digital Pre-Distortion (DPD) function is used, outputs the feedback signal.

15 BAND SIGNAL OUTPUT CONNECTORS [BAND 1]/[BAND 2] (p. 12-2)

Outputs the voltage for band changing.

- ① To connect to an external unit, such as a band-pass filter or a band decoder, use a connection cable (D-sub 15 pin, user supplied).

Touch screen display

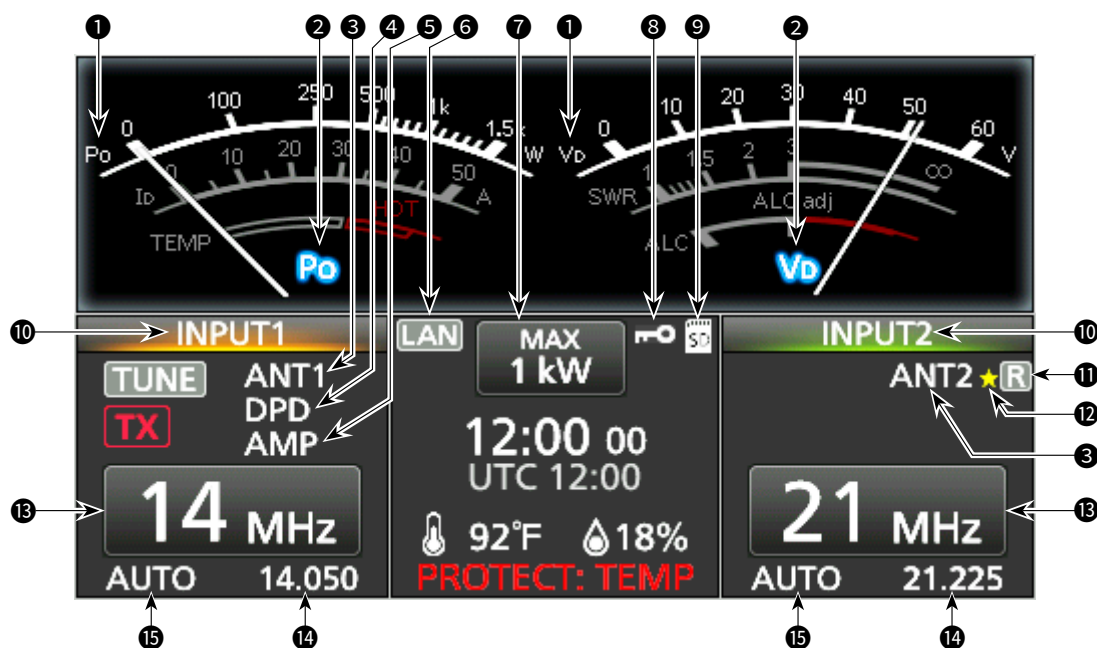

1 METER INDICATOR (p. 4-6)

Displays the meter type.
 Left side: Po, Id, TEMP
 Right side: Vb, SWR, ALC

2 METER NAME INDICATOR **Po** (p. 4-6)

Displays the name of the selected meter.

3 ANTENNA INDICATOR (ANT 1 ~ ANT 6) **ANT1** (p. 4-3)

Displays the selected antenna connector.

4 DPD INDICATOR **DPD** (p. 8-4)

When the Digital Pre-Distortion (DPD) function is turned ON, the indicator is displayed on **INPUT** (Lights orange: TX/RX side).

5 AMPLIFIER INDICATOR **AMP** (p. 4-1)

When the linear amplifier circuit is turned ON, the indicator is displayed on **INPUT** (Lights orange: TX/RX side).

6 LAN INDICATOR **LAN**

Displayed while the linear amplifier and the optional remote control software* are connected through the LAN.

* Future product, as of January 2025.

7 OUTPUT POWER INDICATOR **MAX 1kW** (p. 4-2)

Displays the maximum output power (1 kW or 500 W).

8 LOCK ICON **🔒** (p. 1-1)

Displayed when the Lock function is ON.

9 SD CARD ICON **SD** (p. 6-1)

Displayed when an SD card is inserted.
 ① Blinks while accessing the card.

10 INPUT1/2 READOUT (p. 4-2)

Displays the status of [INPUT 1] and [INPUT 2].

- Orange: TX/RX side (TX and RX)
- Green: RX side (RX only)
- Gray: OFF

11 RX-I/O INDICATOR **R** (p. 4-5)

When an external unit is connected to [RX-ANT IN] and [RX-ANT OUT], the indicator is displayed on **INPUT** (Lights green: RX side).

12 ANTENNA MEMORY INDICATOR **★** (p. 4-4)

Displayed when an antenna connector different from the antenna memory setting is selected.

13 FREQUENCY BAND BUTTON **14 MHz** (p. 4-2)

Displays the operating frequency band.

14 FREQUENCY READOUT **21.225** (p. 3-3)

When the operating frequency of the exciter is synchronized, the frequency is displayed.

15 AUTO ICON **AUTO** (p. 3-3)

Displayed when the linear amplifier is being controlled from the Icom CI-V exciter.

1 PANEL DESCRIPTION

Touch screen display



16 CLOCK/UTC TIME READOUT (p. 7-6)

Displays the current and UTC times on the TIME SET screen.

17 PROTECTION READOUT **PROTECT: TEMP**

(p. 8-1)
Displays the cause of protection circuit operation.

18 TEMPERATURE/HUMIDITY READOUT (p. 7-4)

92°F 18%
Displays intake air temperature and humidity.

19 TX STATUS INDICATOR **TX**

Displayed on **INPUT** (Lights orange: TX/RX side).
① **TX** is displayed while the exciter is transmitting.

20 TUNING INDICATOR **TUNE** (p. 4-1)

When the internal antenna tuner is turned ON, the indicator is displayed on **INPUT** (Lights orange: TX/RX side).
① **TUNE** is displayed while manually tuning.

Touch screen display

◇ MENU screen



- Push **MENU** to open the MENU screen.
 - ① To close the MENU screen, push [↶].

◇ QUICK MENU screen



- You can display the QUICK MENU screen by pushing **QUICK** after selecting the item on the MENU screen.
 - ① To close the QUICK MENU screen, push [↶].

Keyboard entering and editing

◇ Entering and editing characters

You can enter and edit the items in the following table.

MENU	Category	Item	Selectable characters	Maximum characters
SET	Network	Network Name	A to Z, 0 to 9, (space), ! " # \$ % & () + , - . ; = @ [] ^ _ ` { } ~	15
	Display	My Call	A to Z, 0 to 9, (space), / @ - .	10
	Time Set	NTP Server Address	A to Z, a to z, 0 to 9, - .	64
		CLOCK2 Name	A to Z, a to z, 0 to 9, (space), ! " # \$ % & ' () * + , - . / : ; < = > ? @ [\] ^ _ ` { } ~	3
SD Card	Save Setting	A to Z, a to z, 0 to 9, (space), ! # \$ % & ' () * + , - . / : ; < = > @ [\] ^ _ ` { } ~ ① Illegal characters: / : ; * ? " < > \	23	
ANT	ANT1~ANT6 Settings	Name	A to Z, a to z, 0 to 9, (space), ! " # \$ % & ' () * + , - . / : ; < = > ? @ [\] ^ _ ` { } ~	16

1 PANEL DESCRIPTION

Keyboard entering and editing

◆ Keyboard types

You can select the Full Keyboard or Ten-key pad in "Keyboard Type" on the FUNCTION screen. (p. 7-2)

MENU » SET > Function > **Keyboard Type**

① You can also select the Full Keyboard or Ten-key by pushing **QUICK** while displaying an entry mode screen.

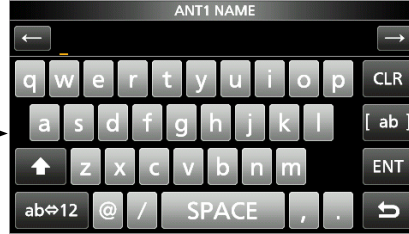
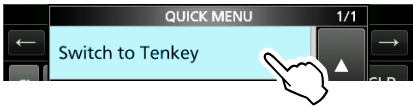

① You can select the full keyboard layout in "Full Keyboard Layout" on the FUNCTION screen. (p. 7-2)

MENU » SET > Function > **Full Keyboard Layout**

◆ Entering and editing

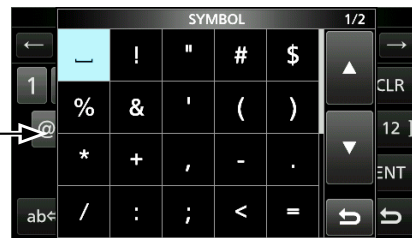
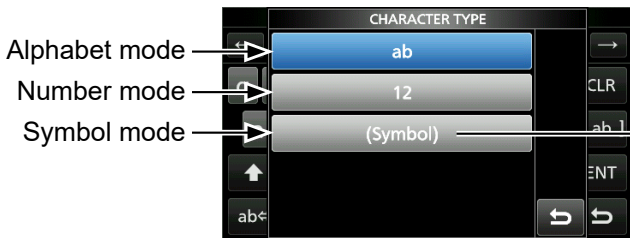
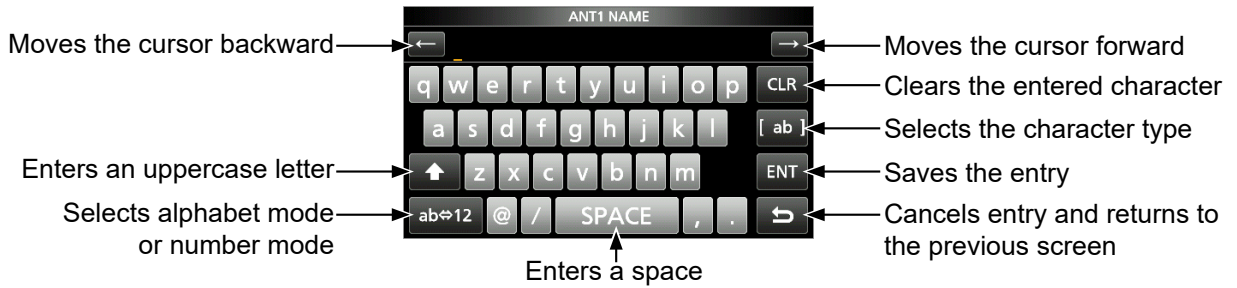

Keyboard entering and editing

◇ Entering and editing example

Entering “Yagi 1” in ANT 1.

1. Open the ANTENNA screen.
 [MENU] » [ANT]
2. Touch “ANT1 Settings.”
 • The ANT1 SETTINGS screen is displayed.

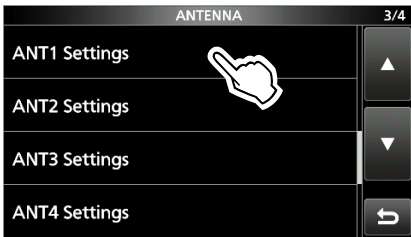

3. Touch “Name.”
 • The ANT1 NAME screen is displayed.

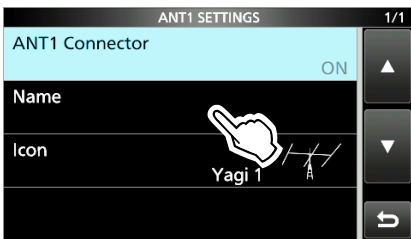

4. Touch [↑], and then touch [Y].
 ⓐ Touching [↑] changes between uppercase and lowercase letters.



5. Touch [a], [g], and then [i].
6. Touch [SPACE] to enter a space.



7. Touch [[ab]].
 • The CHARACTER TYPE screen is displayed.



8. Touch [12].

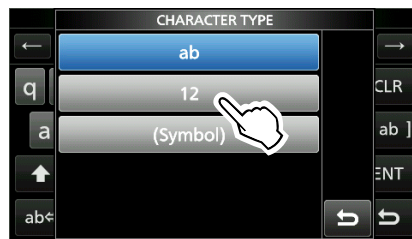

9. Touch [1].
10. Touch [ENT] to save the entry.

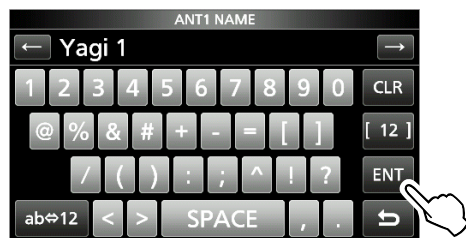

- Returns to the previous screen.

Attaching the controller

1. Insert the bottom of the controller into the projection (❶).

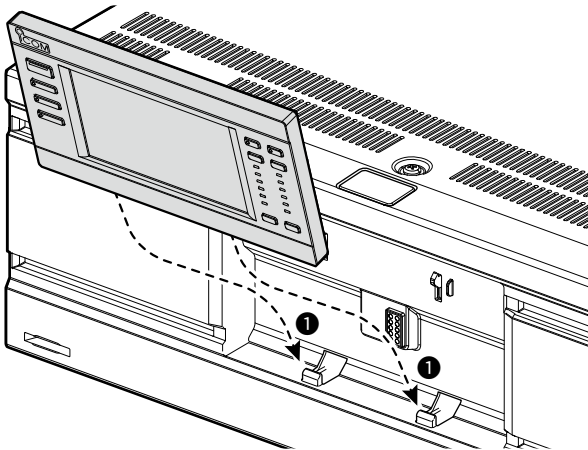

2. Push the controller in the direction of the arrow (❷) until the panel is locked and makes a 'click' sound.

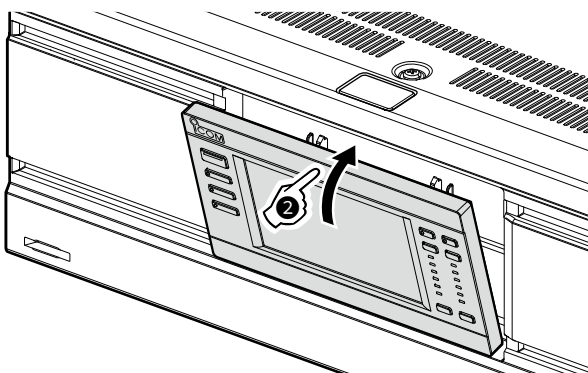

CAUTION: DO NOT push on the LCD display when attaching the controller to the main unit. This could damage the display.

Using the controller separately from the main unit

◇ Detaching from the main unit

1. Push the release button (❶) until the controller tilts forward (❷), and then remove the controller.

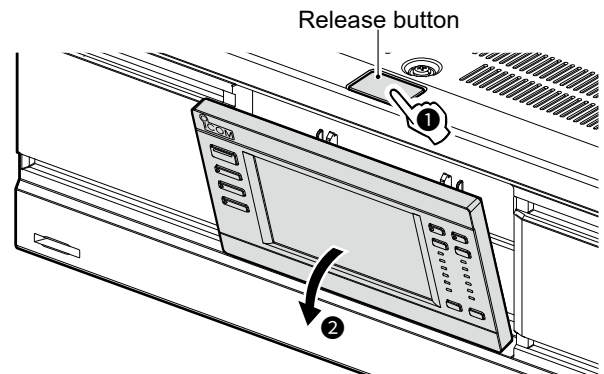

2. Insert the bottom of the dummy panel into the projection (❶).

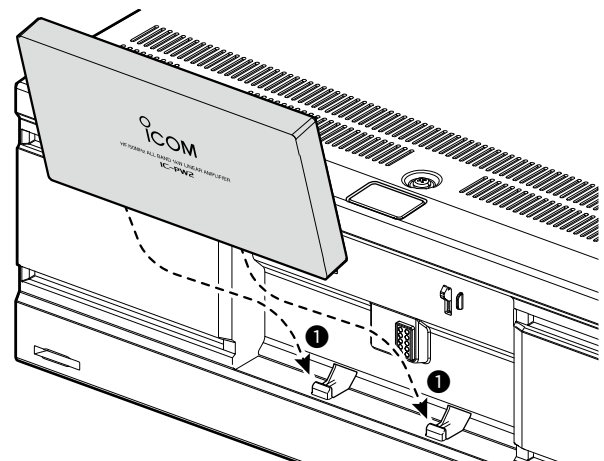

3. Push the panel in the direction of the arrow until the panel is locked and makes a 'click' sound.

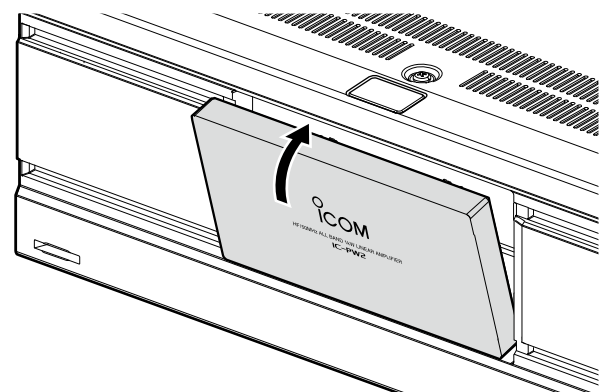

◇ Connecting the controller cable

Insert the controller cable in the direction of the arrow until the cable is locked and makes a 'click' sound.

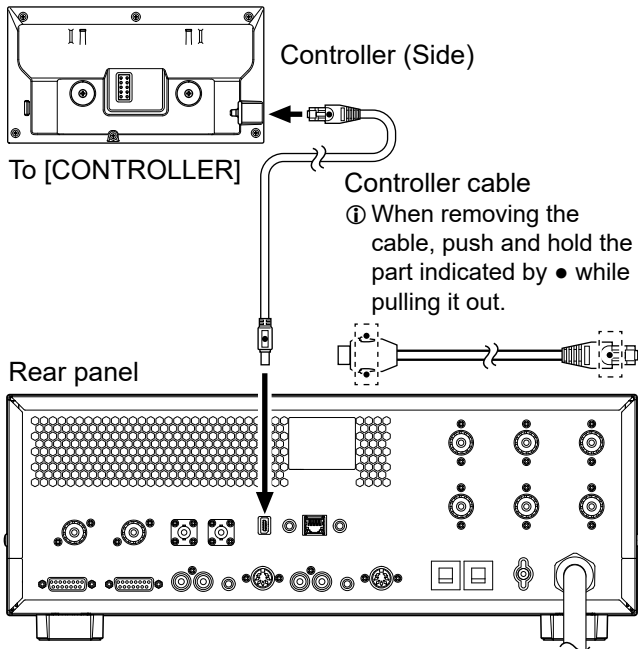

◇ Attaching the mounting bracket stand

Attach the bracket to the rear panel magnets of the controller, as shown below.

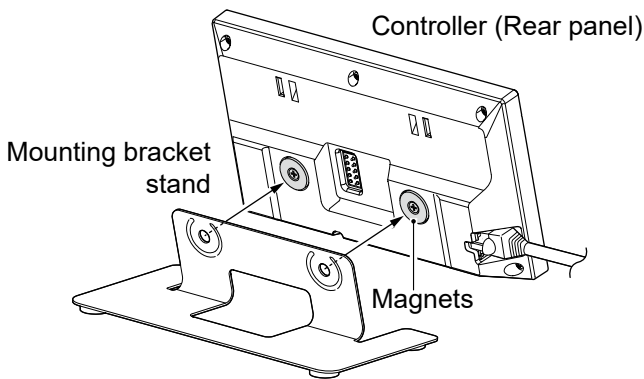

◇ Attaching to a flat surface

The magnets on the rear panel of the controller can be attached to a steel shelf.

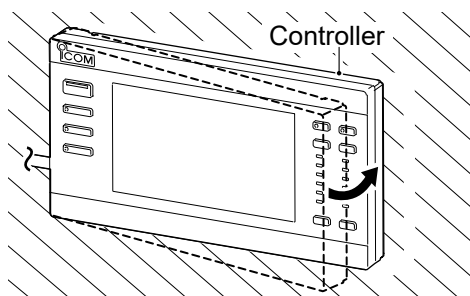

BE CAREFUL! not to pinch your finger when attaching the controller.

Select a location

Select a location for the linear amplifier that enables adequate air circulation, free from extreme heat, cold or vibration, and other electromagnetic sources.

Never place the amplifier in areas such as:

- Temperatures below -10°C ($+14^{\circ}\text{F}$) or above $+40^{\circ}\text{C}$ ($+104^{\circ}\text{F}$).
- An unstable place that slopes or vibrates.
- In direct sunlight.
- High humidity and temperature environments.
- Dusty environments.
- Noisy environments.

CAUTION: Always have 2 people carry, lift, or turn over the amplifier.

Heat dissipation

- **NEVER** install the linear amplifier in a place without adequate ventilation. Heat dissipation may be reduced, and the amplifier may be damaged.
- **DO NOT** place the linear amplifier against walls or put anything on top of the amplifier. This may block airflow and overheat the amplifier.
- **DO NOT** touch the linear amplifier after transmitting continuously for long periods of time. The amplifier may become hot.

Grounding

To prevent electrical shock, television interference (TVI), broadcast interference (BCI), and other problems, ground the linear amplifier using the ground terminal [GND] on the rear panel.

For best results, connect a heavy gauge wire or strap to a long ground rod. Make the distance between the [GND] terminal and the ground rod as short as possible.

① To connect to [GND], use the supplied grounding lug.

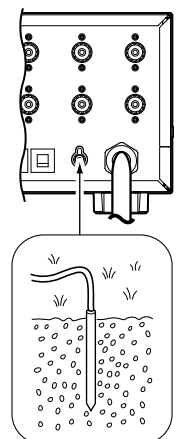

⚠ WARNING! NEVER connect the [GND] terminal to a gas or electric pipe since the connection could cause an explosion or electric shock.

Connecting the AC power cable

◇ About the power supply voltage

The linear amplifier is compatible with a 90 ~ 132 V or 180 ~ 264 V AC (50 Hz/60 Hz) power source. When the amplifier is connected to a 180 ~ 264 V AC power source, the output power can be switched between 1 kW and 500 W. (p. 4-2)

NOTE:

- When the amplifier is connected to a 90 ~ 132 V AC power source, the output power is fixed at 500 W. To improve the power supply efficiency and longer the period of transmission, we recommend using a 180 ~ 264 V AC power source.
 - ① To install a 180 ~ 264 V AC line, ask a qualified licensed electrician.
- Only a 180 ~ 264 V AC power source can be used for the EUR version.

◇ About an AC power plug

For the USA and EXP versions:

Use an AC power plug that matches the shape of the outlet to be used because the plug is not included. Connect each plug terminal to each wire (Blue or White, Brown or Black, and Green/Yellow) of the AC power cable that is connected to the power supply, as shown below.

- ① AC input voltage is automatically recognized.
- ② Each wire color of the AC adapter cable differs, depending on the linear amplifier version.

NOTE:

- The total current consumption is 19 ~ 21 A, including the exciter. Use a line with sufficient current capacity, considering the power consumption of household electrical appliances (electric heaters, air conditioners, microwave ovens, and so on).
- Icom is not responsible for any damage caused by incorrect wiring of the AC power plug or power failure.

Single-phase 3-wire line (180 ~ 264 V AC)

- The blue (or white) and brown (or black) wires can be connected to either the hot or neutral terminal.
 - The green/yellow wire must be connected to the protective earth ground.
- ① Current consumption: Less than 15 A at 1 kW output

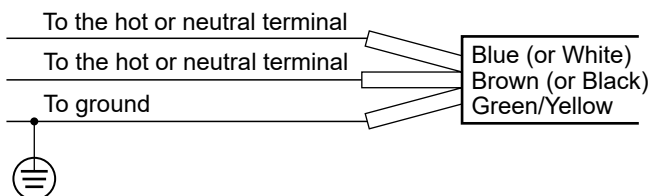

Single-phase 2-wire line (90 ~ 132 V AC)

- The blue wire (or white) must be connected to the neutral terminal.
 - The brown (or black) wire must be connected to the hot terminal.
 - The green/yellow wire must be connected to the protective earth ground.
- ① Current consumption: Less than 15 A at 500 W output

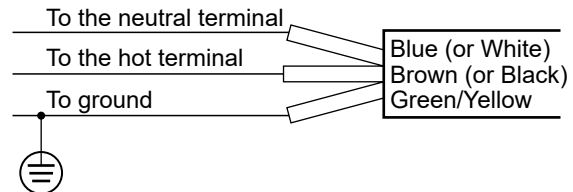

Three-phase 3-wire line (180 ~ 264 V AC)

- The blue (or white) and brown (or black) wires can be connected to any of the 3 hot terminals.
 - The green/yellow wire must be connected to the protective earth ground.
- ① Current consumption: Less than 15 A at 1 kW output

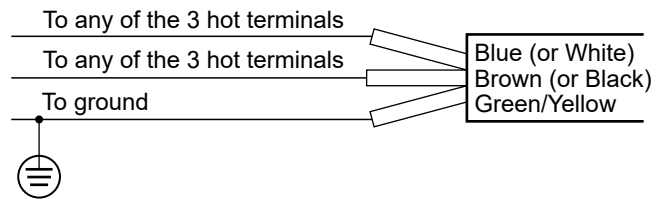

For the EUR version:

BE SURE to connect the AC power plug to an AC power outlet with a protective earth terminal.

AC power outlet with a protective earth terminal AC power plug (Comes with the F type)

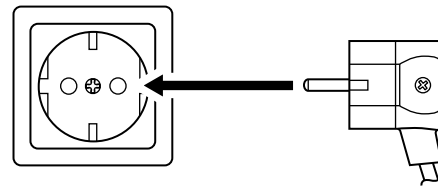

⚠ WARNING! NEVER use the linear amplifier unless the AC power outlet is easily accessible and near the amplifier. If any abnormal condition occurs, disconnect the AC power plug.

Exciter

To operate the linear amplifier at the 1 kW output power, connect a 100 W or 200 W type exciter with an antenna impedance of 50 Ω.

Caution for a non-Icom exciter: DO NOT transmit from the exciter without being connected to the SEND line (transmission/reception switching). (pp. 2-7, 2-8)

- ① Due to internal relay protection, if excessive input is detected, the screen may display that the linear amplifier circuit is turned OFF.

Antenna

◇ Impedance

Before using an antenna, connect it to a 50 Ω coaxial cable and check that the antenna SWR is less than 1.5:1. Otherwise, the linear amplifier will be damaged.
If the antenna SWR is more than 1.5:1, adjust it with the internal or external antenna tuner.

◇ About the maximum input power

Use an antenna with the maximum input power of 2 kW (PEP) and 1 kW (CW) or more.
Exceeding the antenna's maximum input power may damage the antenna.

Connecting to exciters

NOTE:

- Before connecting, confirm that the power plugs of the linear amplifier and an exciter are unplugged.
- See the exciter's instruction manual for operation.

Connecting 2 Icom exciters to [INPUT 1] and [INPUT 2] (p. 2-5)

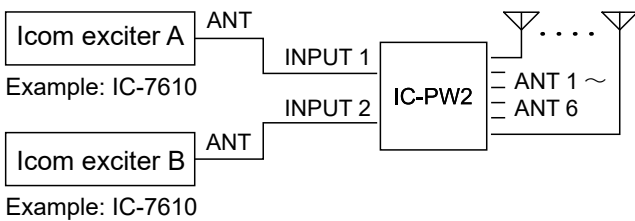

Connecting 1 Icom and 1 non-Icom exciter to [INPUT 1] and [INPUT 2] (p. 2-7)

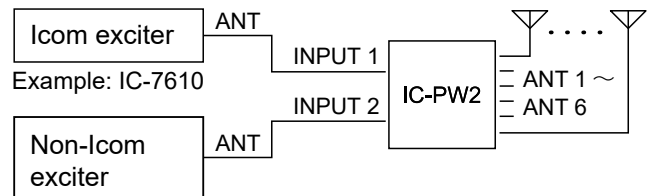

Connecting 1 Icom exciter to [INPUT 1] (p. 2-5)

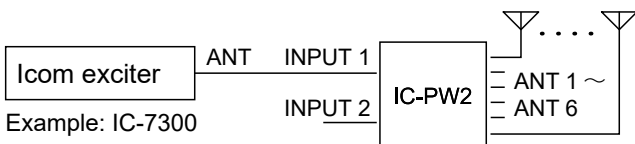

Connecting 1 non-Icom exciter to [INPUT 1] (p. 2-7)

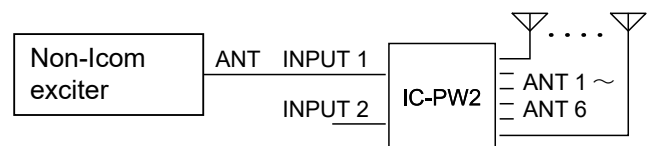

Connecting 1 Icom exciter to [INPUT 2] (p. 2-6)

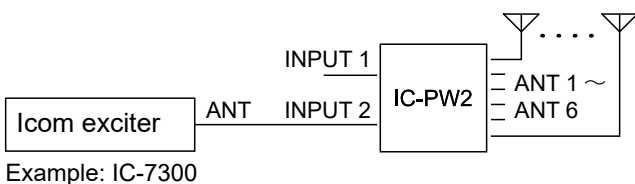

Connecting 2 non-Icom exciters to [INPUT 1] and [INPUT 2] (p. 2-8)

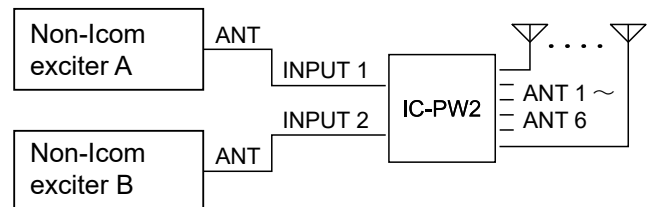

Connecting 1 Icom exciter to [INPUT 1] and [INPUT 2] (p. 2-6)

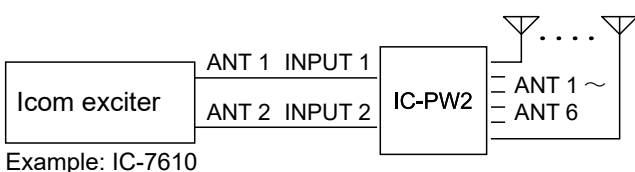

2 INSTALLATION AND CONNECTIONS

Connecting to excitors

◇ Connecting 2 Icom excitors to [INPUT 1] and [INPUT 2]

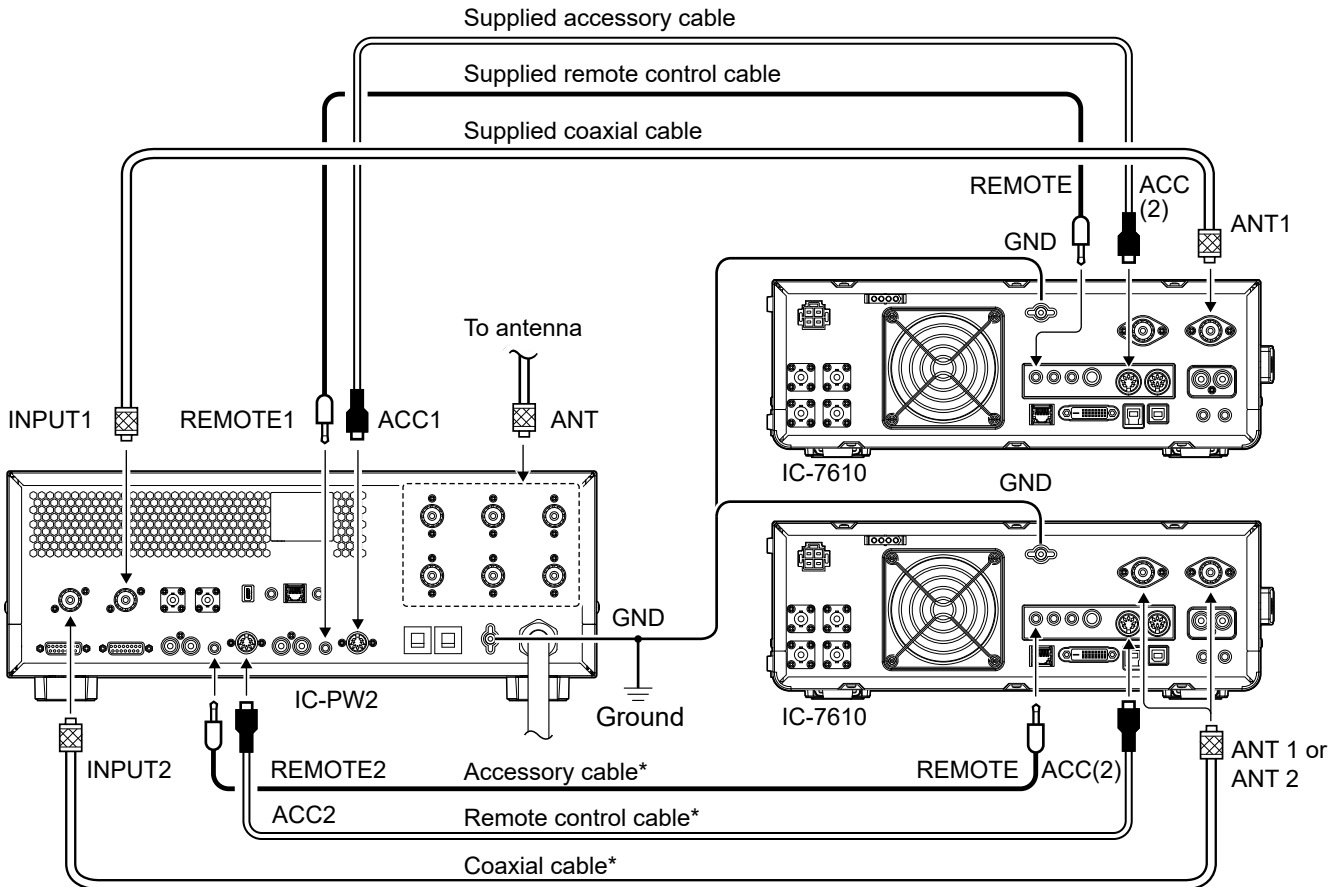

* To connect the second Icom exciter, use the optional OPK-5 (p. 11-1).

◇ Connecting 1 Icom exciter to [INPUT 1]

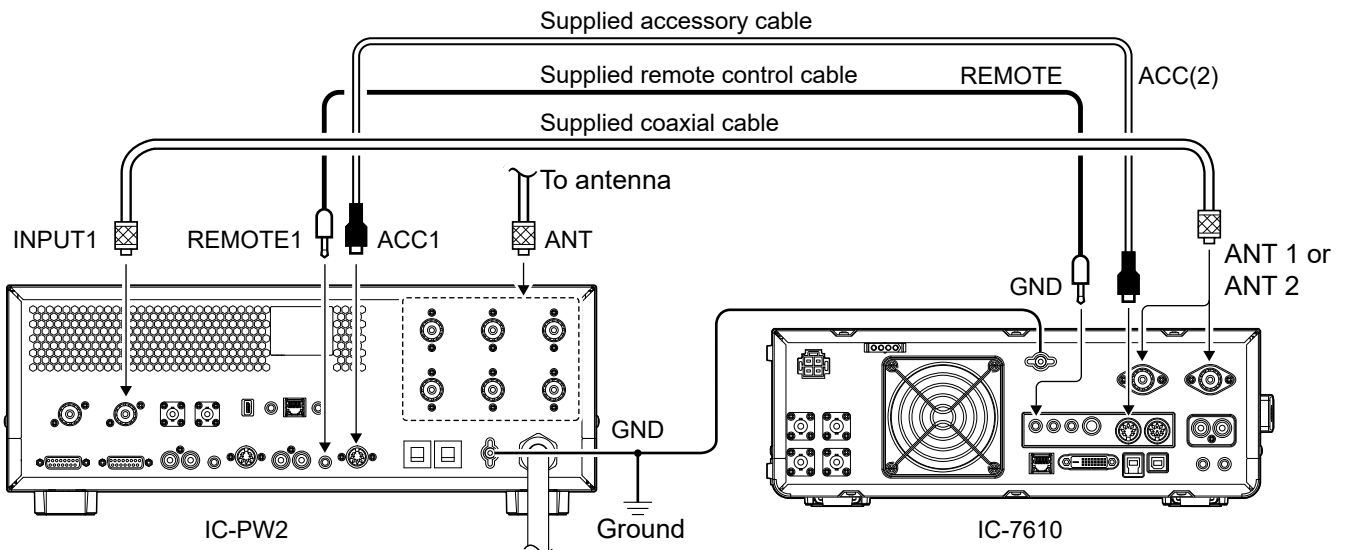

Connecting to exciters

◇ Connecting 1 Icom exciter to [INPUT 2]

2

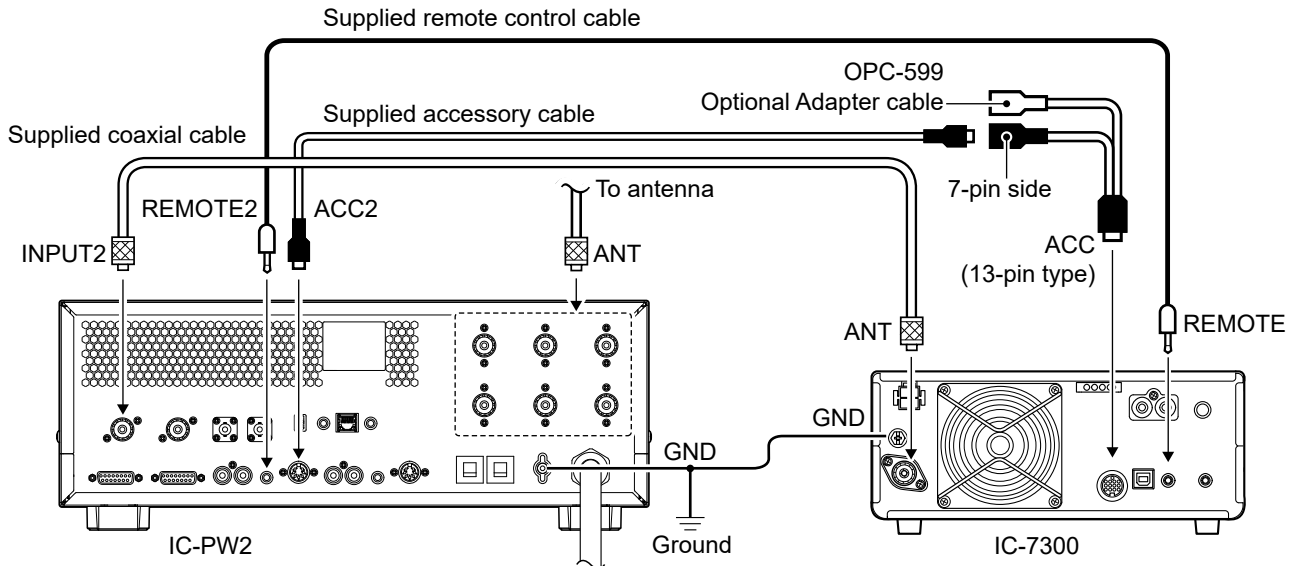

◇ Connecting 1 Icom exciter to [INPUT 1] and [INPUT 2]

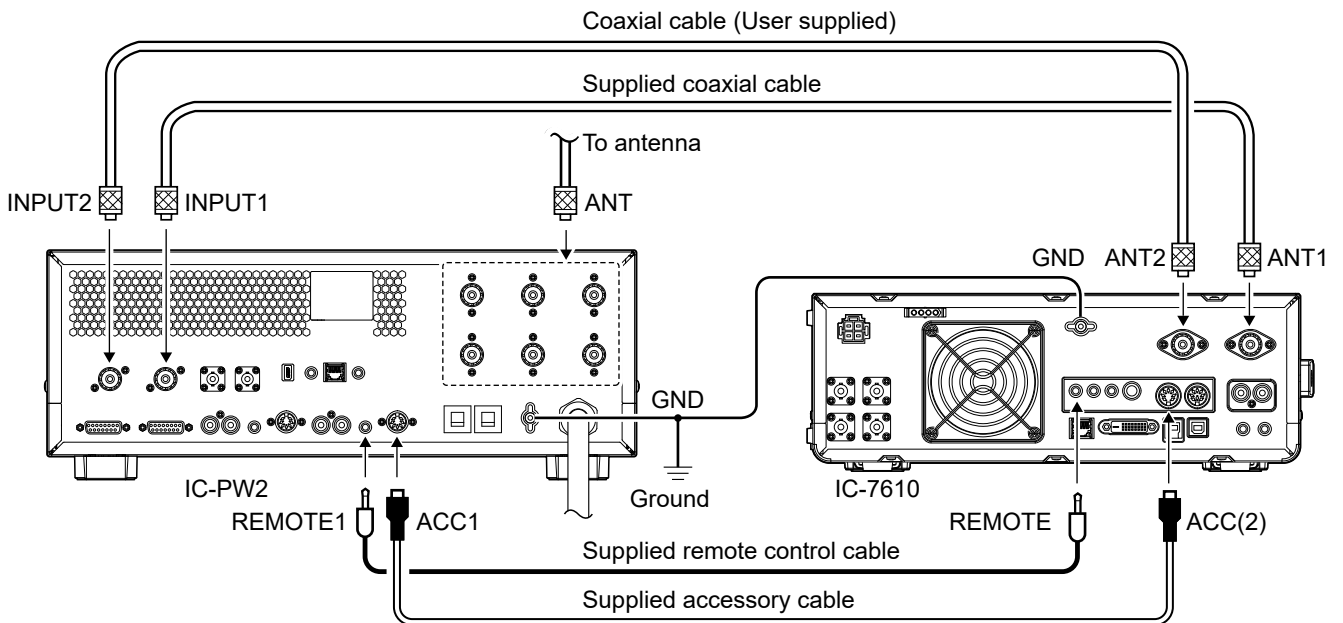

- ① To operate the amplifier in synchronization with the exciter's frequency data:
 - The firmware of the IC-7851, IC-7850 (Discontinued), or IC-7610 must be updated to the latest version.
 - Select "ON" in the "IC-PW2 Dual Connection Mode" setting on the exciter.
- ① When operating in this connection, you cannot switch the antenna, select the receive-only antenna (RX-ANT), and set antenna memory, using the exciter.
- ① When an IC-7851 or IC-7850 is connected, the linear amplifier is designed to work by connecting a coaxial cable to their ANT 1 or ANT 2.

2 INSTALLATION AND CONNECTIONS

Connecting to exciters

◇ Connecting 1 Icom and 1 non-Icom exciter to [INPUT 1] and [INPUT 2]

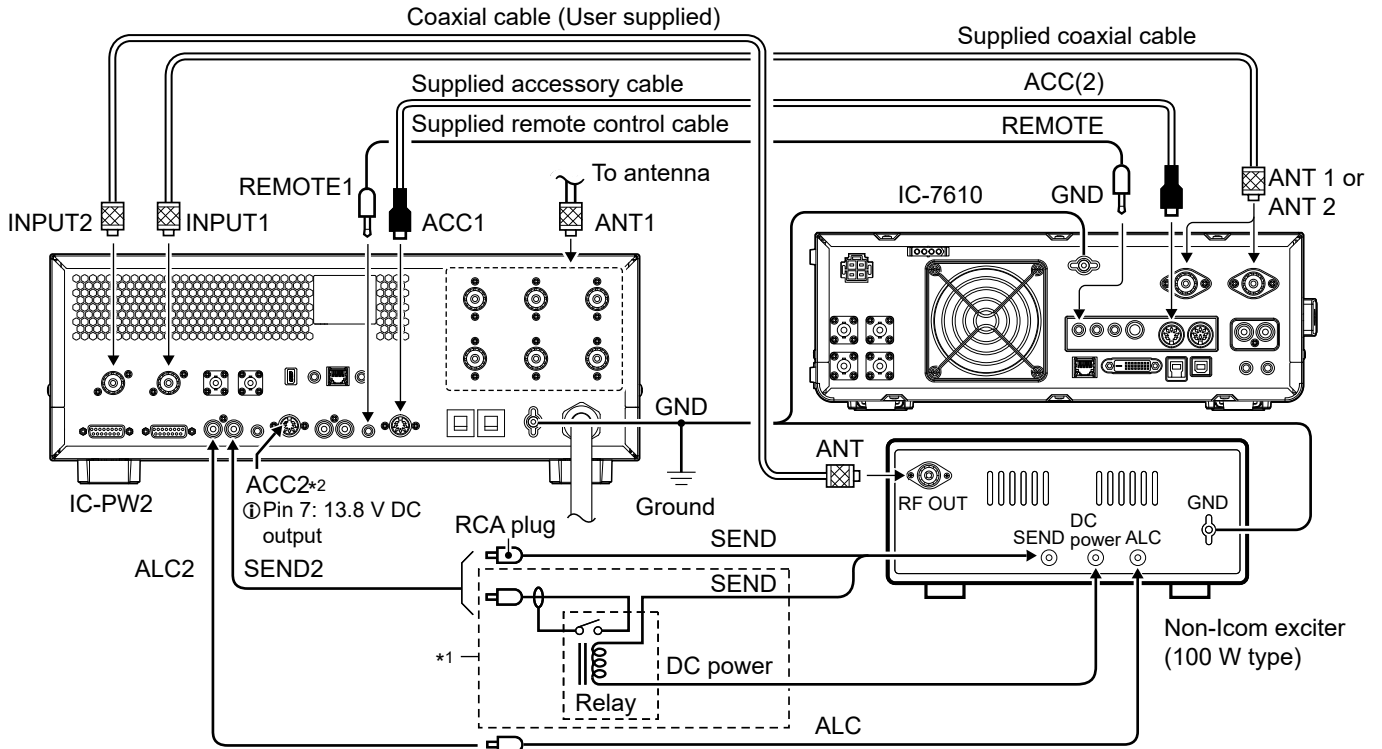

*1 When the relay contact capacity of the SEND line (transmission/reception switching) is less than 5 V DC/20 mA, connect using an external relay.

*2 To operate the linear amplifier in the Antenna Selector mode with a non-Icom exciter, supply 13.8 V DC to [ACC 2] using a DIN connector.

① The antenna connector must be switched to the one used for each frequency band by pushing **ANT**. (p. 4-3)

◇ Connecting 1 non-Icom exciter to [INPUT 1]

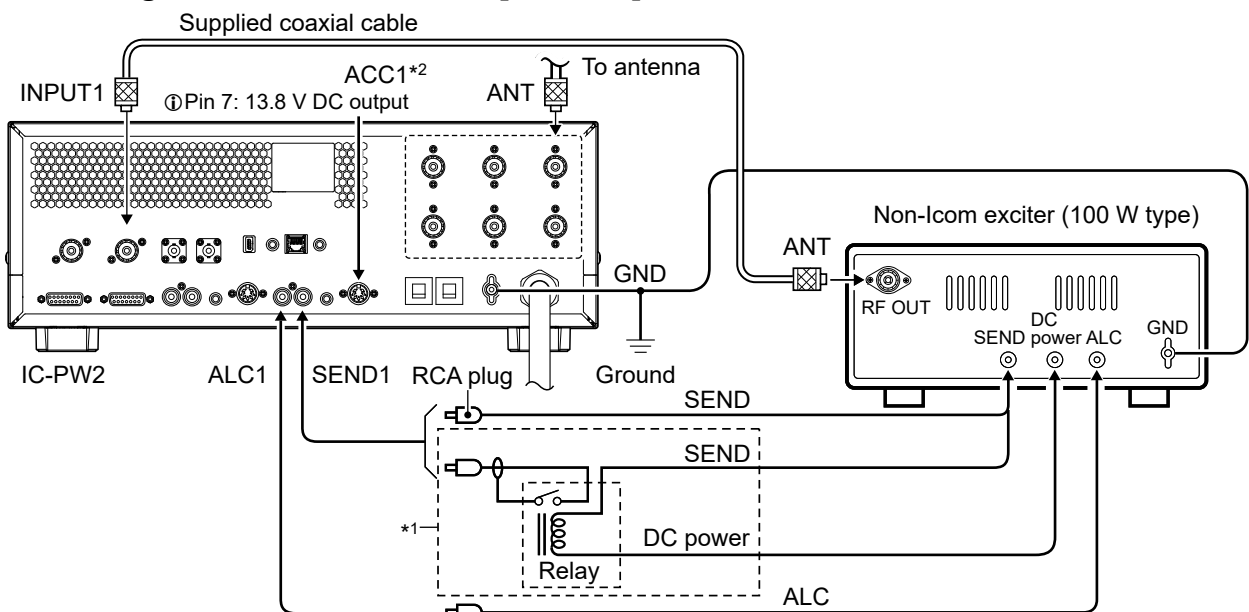

*1 When the relay contact capacity of the SEND line (transmission/reception switching) is less than 5 V DC/20 mA, connect using an external relay.

*2 To operate the linear amplifier in the Antenna Selector mode with a non-Icom exciter, supply 13.8 V DC to [ACC 1] using a DIN connector.

① The antenna connector must be switched to the one used for each frequency band by pushing **ANT**. (p. 4-3)

Connecting to exciters

◇ Connecting 2 non-Icom exciters to [INPUT 1] and [INPUT 2]

2

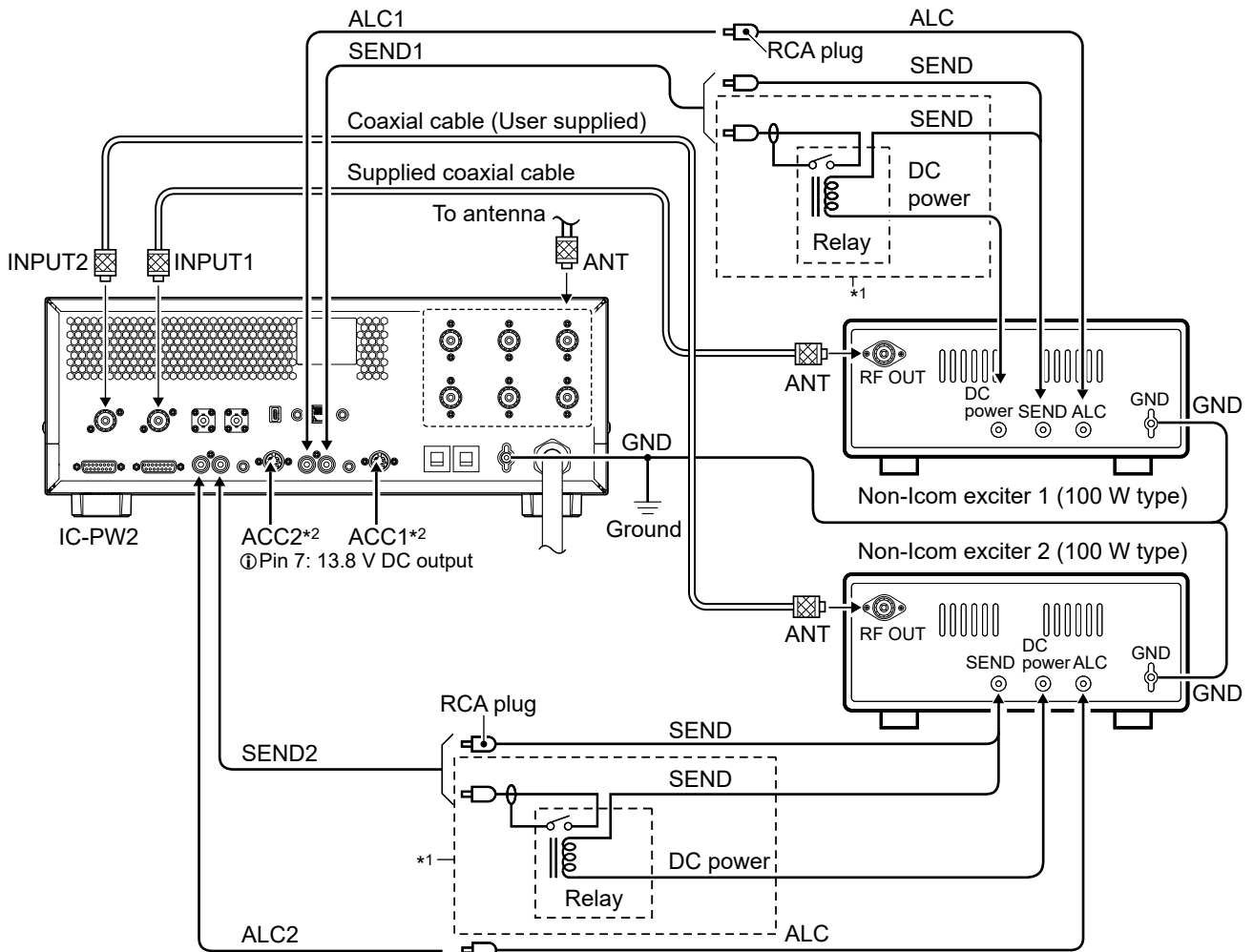

*1 When the relay contact capacity of the SEND line (transmission/reception switching) is less than 5 V DC/20 mA, connect using an external relay.

*2 To operate the linear amplifier in the Antenna Selector mode with non-Icom exciters, supply 13.8 V DC to [ACC 1] and [ACC 2] using a DIN connector.

① The antenna connector must be switched to the one used for each frequency band by pushing **ANT**. (p. 4-3)

Before initial setup

Confirm that the linear amplifier, excitors, and AC power source are correctly connected, as described below.

Otherwise, the exciter cannot externally control the amplifier or adjust values, even if the initial setup is done.

- The ground of the amplifier and the AC power cable are correctly connected to [GND].
- The AC power plug is correctly connected to the power cable and outlet.
- The controller is correctly attached to the main unit or correctly separated using the supplied controller cable.
- Antennas (impedance: 50 Ω) are correctly connected.
- The excitors are correctly connected.

CI-V settings

To change the frequency band in synchronization with the operation of an Icom exciter, check the CI-V settings on the exciter.

- ① The CI-V settings can be checked in the Set mode of the Icom exciter.
- ① The linear amplifier cannot be remotely controlled by a non-Icom exciter using CI-V.
When using a non-Icom exciter, change the frequency band of the amplifier and switch an antenna before transmitting.
- ① See the exciter's instruction manual for its operation.

◇ CI-V address

Setting the exciter's address for the CI-V remote control.

- ① Even if 2 Icom excitors are connected, they will operate with their respective CI-V address.

◇ CI-V baud rate

Setting the CI-V data transfer speed.

- ① Even if 2 Icom excitors are connected, they will operate with their respective baud rate.

◇ CI-V Transceive function

Confirm that the CI-V Transceive setting of the Icom exciter is set to "ON."

- ① Even if the function is turned OFF, the operation band can be synchronized, but it takes time to synchronize due to frequency data acquisition.
- ① If synchronization is delayed by about 1 second even if the function is turned ON, change the CI-V baud rate of an Icom exciter to "19200" or "9600."

Turning power ON or OFF

- Push **POWER**.
 - The opening screen is displayed.
- To turn OFF the linear amplifier, hold down **POWER** for 1 second.
 - ① When an Icom exciter is turned ON, the amplifier operates in the Antenna Selector mode. (p. 4-1)

CAUTION: After prolonged operation or operation in high room temperatures, the inside of the linear amplifier becomes hot.

DO NOT turn OFF the amplifier until the built-in cooling fan has cooled the internal temperature.

Connection mode

The settings are for the RF input connectors ([INPUT 1] and [INPUT 2]) that the exciter is connected to.

◇ Setting the exciter connection

Select how the excitors are connected to [INPUT 1] and [INPUT 2] from the following options.

- Connect Only INPUT1
- Connect Only INPUT2
- Connect Two Excitors to INPUT1 & 2
- Connect an Exciter to INPUT1 & 2

1. Open the EXCITER screen.

MENU » **Exciter**

2. Touch "Exciter Connection."

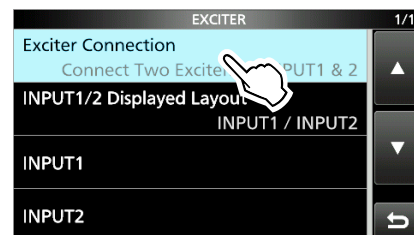

3. Touch the desired item.

(Example: Connect Only INPUT1)

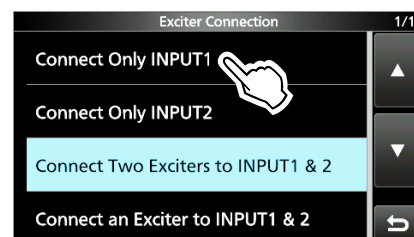

4. Push **MENU** to return to the Main screen.

Connection mode

◇ Switching the display layout of [INPUT 1] and [INPUT 2]

Set the display layout of [INPUT 1] and [INPUT 2] according to the placement of the exciters.

① When “Connect an Exciter to INPUT1 & 2” is selected in the “Exciter Connection” setting, the display layout cannot be switched.

1. Open the EXCITER screen.

MENU » **EXCITER**

2. Touch “INPUT1/2 Displayed Layout.”

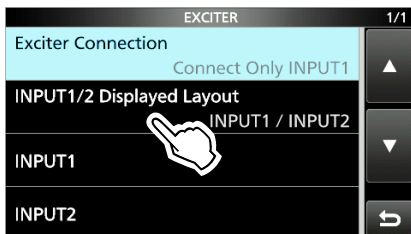

3. Touch the desired item.
(Example: INPUT2 / INPUT1)

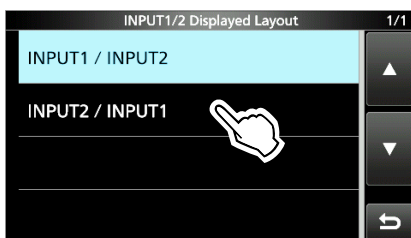

4. Push **MENU** to return to the Main screen.
 - The display layout of [INPUT 1] and [INPUT 2] is switched.

◇ The CI-V settings of [INPUT 1] and [INPUT 2]

Set the CI-V settings for [INPUT 1] and [INPUT 2] to the same setting as an Icom exciter.

1. Open the INPUT1 or INPUT2 screen.
(Example: INPUT1)

MENU » **EXCITER > INPUT1**

MENU » **EXCITER > INPUT2**

2. Touch the item you want to set.
(Example: CI-V Address)

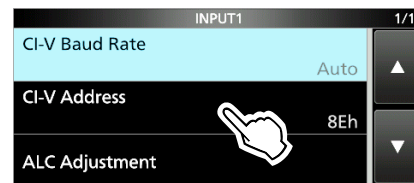

3. Touch [+] or [-] to change the value.



4. Push **MENU** to return to the Main screen.

CI-V Baud Rate (Default: Auto)

Sets the CI-V data transfer rate to 4800, 9600, 19200, or Auto.

① When “Auto” is selected, the baud rate is automatically set according to the data rate of the Icom exciter.

CI-V Address (Default: 8Eh)

Sets the same CI-V address as set on the Icom exciter.

3 INITIAL SETUP

Connection mode

◇ Synchronization with the exciter

After the CI-V setting, confirm that the operating frequency is synchronized with the exciter.

① When “Connect an Exciter to INPUT1 & 2” is selected in the “Exciter Connection” setting, the screen of step 3 is automatically displayed.

1. Touch the frequency band button (Example: 1.8 MHz).
 - The BAND window is displayed.

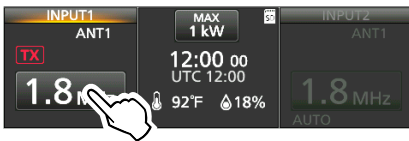

2. Touch “AUTO.”
 - The BAND window is closed.



3. Confirm that “AUTO” and the exciter's operating frequency are displayed under the button.



Exciter's operating frequency

① When only “AUTO” is displayed, or the operating frequency is not synchronized, turn OFF the exciter and the amplifier and then turn them ON again, or check the settings of each device.

NOTE: When an operating frequency over 65 MHz is selected on the exciter, the amplifier does not synchronize the frequency.

ALC adjustment

To use the linear amplifier circuit of the IC-PW2, adjusting the gain correction and the ALC operating range for the exciter by the following steps is necessary.

① After adjusting at 1 operating frequency, there is no need to readjust for each frequency band.

NOTE:

- Check periodically as the adjustment level may shift due to the surrounding environment (install a new antenna, replace the exciter, temperature, and so on) or aging.
- When the linear amplifier is connected to a 180 ~ 264 V AC power source, both 1 kW and 500 W require adjustment.
- When using a dummy load (pseudo load: 50Ω), connect one with a sufficient margin for the maximum input power.

Confirming the antenna SWR

Confirm that the SWR of the antenna (impedance: 50Ω) to be used is less than 1.5:1 at the transmitting frequency for the ALC adjustment.

1. Push **ANT** to select the antenna you want to use.
 - ① When 2 exciters are connected, push **INPUT** to change the desired RF input connector to **INPUT** (Lights orange: TX/RX side).
2. Push **AMP** and **TUNER** to turn OFF the linear amplifier circuit and the internal antenna tuner.
 - ① When the circuit or the tuner are OFF, each indicator on the key is OFF.
3. Touch the right side meter to display the SWR meter.
4. Select the same frequency band as the exciter, and then transmit from the exciter.
 - Confirm that the amplifier is transmitting.
5. Check the SWR meter indicates less than 1.5:1.
 - ① If the SWR is more than 1.5:1, adjust the antenna matching.
6. Stop the transmission.

ALC adjustment

Displaying the ALC ADJUSTMENT screen

1. Confirm that the linear amplifier has finished the SWR adjustment.
2. Open the INPUT1/INPUT2 ALC ADJUSTMENT screen. (Example: INPUT1)

MENU » **EXCITER > INPUT1 > ALC Adjustment**

MENU » **EXCITER > INPUT2 > ALC Adjustment**

3. When the amplifier is connected to a 180 ~ 264 V AC power source, touch the output power used for the ALC adjustment. (Example: 1 kW)

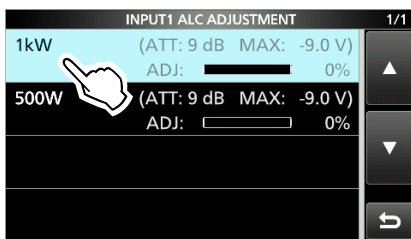

- ① When the adjustment is finished at 1 kW or the amplifier is connected to a 90 ~ 132 V AC power source, touch "500 W."

- The ALC ADJUSTMENT screen for the selected output power is displayed.

Automatically adjusting the ALC level

(Example: 1 kW output)

1. Touch the meters to display the Po and ALC meters.
2. Change the exciter's operating mode to RTTY or CW.
3. Touch "AUTO."

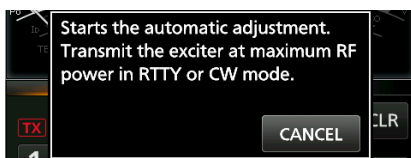
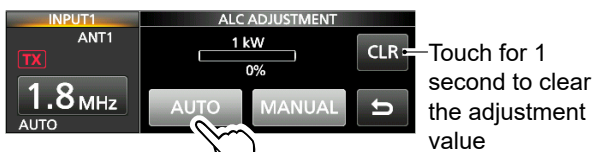

- ① If the message is not displayed, check that the exciter does not transmit.
- ① To clear the previous adjustment value, touch [CLR] for 1 second. When the value is cleared, "0%" is displayed.

4. Change the exciter's output power to maximum, and then transmit.
 - The message disappears, and **TX** is displayed.

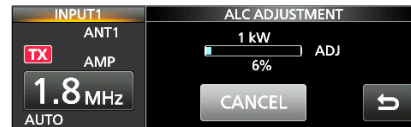

- ① When "ADJ" is displayed, the linear amplifier circuit is automatically turned ON, and the internal antenna tuner is automatically turned OFF.
5. After the adjustment complete message is displayed, stop the transmission.
 - The message disappears, and the ALC ADJUSTMENT screen is displayed.

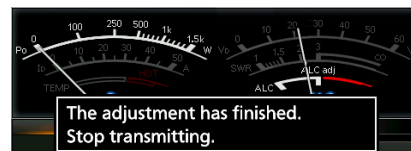

TIP: When the auto adjustment failed message is displayed, do one of the following steps.

- Check the connection with the exciter and that the output power is between 100 and 200 W. Then readjust the level from step 3 again.
- Manually adjust the level.
 - ① See the next page for details.
- When the exciter's ALC meter goes out of the allowed zone, adjust the transmit output power and Drive Gain level.

NOTE (Except when the exciter's DPD function is turned ON): When using an exciter in the AM mode, adjust the exciter's output power so that the unmodulated output power is less than 1/4 of the rated output.

3 INITIAL SETUP

ALC adjustment

Manually adjusting the ALC level

(Example: 1 kW output)

1. Touch the meters to display the Po and ALC meters.
2. Change the exciter's operating mode to RTTY or CW.
3. Touch "MANUAL."

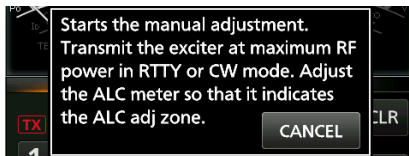
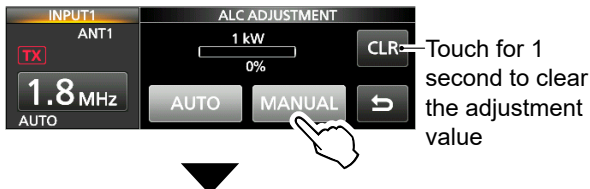

- ① If the message is not displayed, check that the exciter does not transmit.
 - ① To clear the previous adjustment value, touch [CLR] for 1 second. When the value is cleared, "0%" is displayed.
4. Change the exciter's output power to maximum, and then transmit.
 - The message disappears, and **TX** is displayed.
5. Touch [+] or [-].
 - ① **DO NOT** exceed "ALC adj" on the ALC meter.
 - ① [+] and [-] can only be used while transmitting.



- ① While adjusting, the linear amplifier circuit is automatically turned ON, and the internal antenna tuner is automatically turned OFF.
6. To finish the adjustment, touch "SET."
 - The adjustment complete message is displayed.

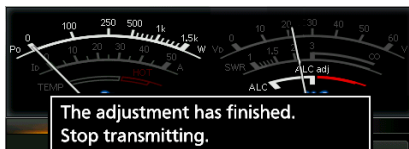

7. Stop the transmission.
 - The message disappears, and the ALC ADJUSTMENT screen is displayed.
 - ① If you cannot adjust the ALC level, check the connection with the exciter and that the output power is between 100 and 200 W. Then, readjust the level.

NOTE (Except when the exciter's DPD function is turned ON): When adjusting the ALC level in the AM mode, adjust the exciter transmit output power to 1/4 of the rated output.

Operation modes

IC-PW2 has the following 3 operation modes. The mode can be changed by turning ON or OFF the **POWER**, **TUNER**, and **AMP**. (p. 1-2)

① Power (13.8 V DC) must be supplied from [ACC 1] or [ACC 2] by turning ON an exciter or an external device.

◇ Antenna Selector mode

POWER: OFF (Indicator: OFF)

Even if the linear amplifier is turned OFF, it operates as an antenna selector, and **INPUT**, **ANT**, and **QUICK** (Lock) (Only the Lock function) can be used.

① The indicator on **INPUT** lights orange or green, and the selected antenna indicator lights white.

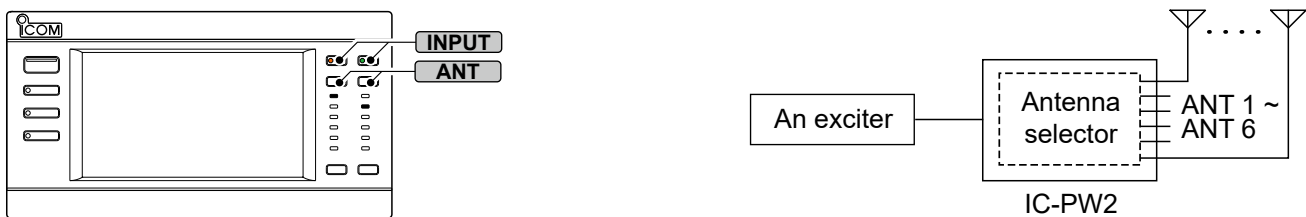

◇ Antenna Tuner mode

POWER: ON (Indicator: lights blue), **TUNER**: ON (Indicator: lights white), **AMP**: OFF (Indicator: OFF)

The amplifier operates as an antenna tuner and antenna selector.

① The ON/OFF settings of the internal antenna tuner and the linear amplifier circuit are saved for each frequency band.

① When operating the amplifier in the Antenna Tuner mode, turn OFF the exciter's internal antenna tuner.

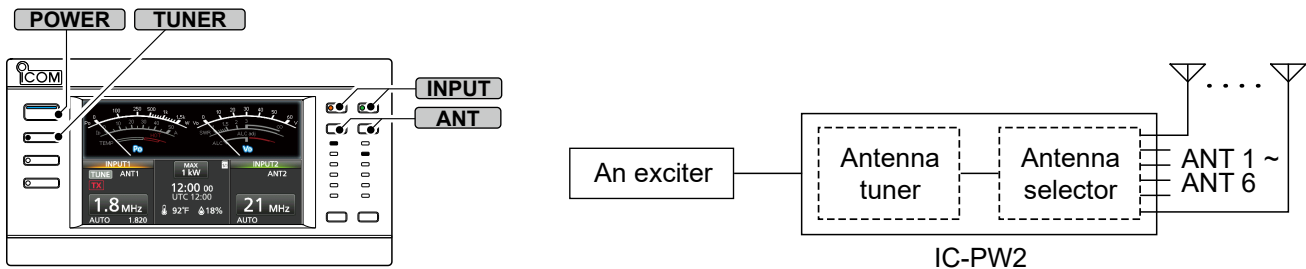

◇ Linear Amplifier mode

POWER: ON (Indicator: lights blue), **TUNER**: ON (Indicator: lights white), **AMP**: ON (Indicator: lights white)

The amplifier operates as an antenna selector, antenna tuner, and linear amplifier.

① Information

- The ON/OFF settings of the internal antenna tuner and the linear amplifier circuit are saved for each frequency band.
- The internal antenna tuner can be turned OFF if necessary.
- During manual tuning (p. 5-1), the linear amplifier circuit is temporarily turned OFF.
- When operating the amplifier in the Linear Amplifier mode, turn OFF the exciter's internal antenna tuner.

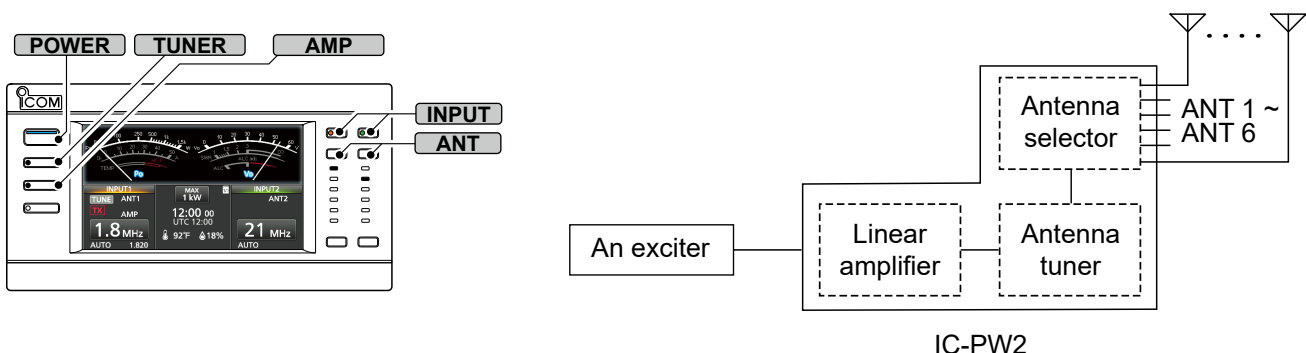

4 BASIC OPERATION

Changing the status of [INPUT 1] and [INPUT 2]

You can change the status of [INPUT 1] and [INPUT 2] by touching the LCD display, or pushing **INPUT**.

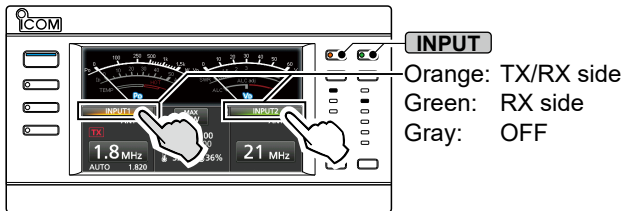

◇ Using the RF input selector

- Push **INPUT** (Indicator lights green: RX side, or is off: OFF) to change to the TX/RX side (Indicator lights orange).
- Hold down **INPUT** (Indicator is off) for 1 second to change to the RX side (Indicator lights green).
- Hold down **INPUT** (Indicator lights orange) for 1 second to change the other RF input connector to the RX side (Indicator lights green) or OFF (Indicator is off).

◇ Using the touch screen display

- Touch **INPUT** (Gray: OFF) or **INPUT** (Lights green: RX side) to change to **INPUT** (Lights orange: TX/RX side).
- Touch **INPUT** (Gray: OFF) for 1 second to change to **INPUT** (Lights green: RX side).
- Touch **INPUT** (Lights orange: TX/RX side) for 1 second to toggle the other selector to **INPUT** (Lights green: RX side) or **INPUT** (Gray: OFF).

You cannot change the status of the [INPUT 1] and [INPUT 2] when:

- [INPUT 1] and [INPUT 2] are controlled by the external devices that are connected to the [INPUT 1/2] jacks.
- Only 1 exciter is connected.
 - ① When only 1 Icom exciter is connected to [INPUT 1] and [INPUT 2], the status of [INPUT 1] and [INPUT 2] will be fixed, as shown below, depending on the exciter's Split function or Dualwatch function settings.

Icom exciter's setting		INPUT indicator	
Split function	Dualwatch function	INPUT 1 (MAIN)	INPUT 2 (SUB)
OFF	OFF	Orange	Gray
OFF	ON	Orange	Green
ON	OFF	Green	Orange
ON	ON	Green	Orange

Switching the maximum output power

Touch **MAX 1kW** or **MAX 500W** to switch the maximum output power.



Selecting the frequency band

You can manually select the frequency band.

- ① When an exciter not supporting CI-V is connected, manually select the same band as the exciter.
- ① When "Connect an Exciter to INPUT1 & 2" is selected in the "Exciter Connection" setting, you cannot change the frequency band.

1. Touch the frequency band button. (Example: 1.8 MHz)
 - The BAND window is displayed.

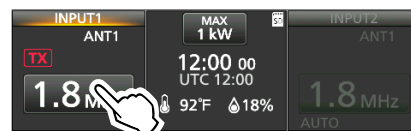

2. Touch the desired band key. (Example: 14)
 - ① The band in operation is displayed in blue.

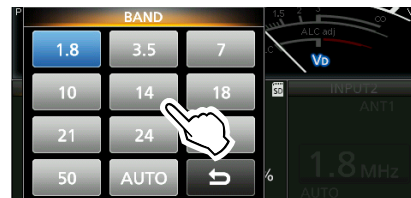

- The selected band is displayed. (Example: 14 MHz)



The band in operation

TIP: About the automatic changing of the frequency band

To automatically follow the frequency band and frequency of the Icom CI-V exciter, touch "AUTO" in the BAND window. (p. 3-3)



- "AUTO" and the band of the Icom exciter are displayed in blue.

- ① The antenna connectors used in each frequency band can be saved on the ANTENNA MEMORY screen. See page 4-4 for details.

Selecting the antenna connector

Change the selected antenna connectors (ANT 1 ~ ANT 6) by touching the LCD display or pushing **ANT**.

ANT

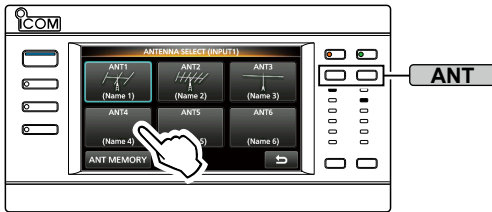

◇ Using the antenna selector

- When the linear amplifier is turned OFF:
 - Push **ANT** to change the antenna connector sequentially between ANT 1 and ANT 6.
 - The selected antenna indicator lights white.
 - ① The same antenna connector cannot be selected for [INPUT 1] and [INPUT 2].
 - ① To change the antenna connector by pushing **ANT** even when the amplifier is turned ON, select “Select Antenna” in the following setting.

MENU » **ANT > [ANT] Switch (Short Push)**

- Hold down **ANT** for 1 second to temporarily change to the antenna connector selected in the following setting.

MENU » **ANT > [ANT] Switch (Hold Down)**

- The selected antenna indicator blinks white.
- ① “(OFF)” is displayed in the antenna connector set to “OFF” in the ANT1 to ANT6 settings.

Example: ANT 4 (OFF)

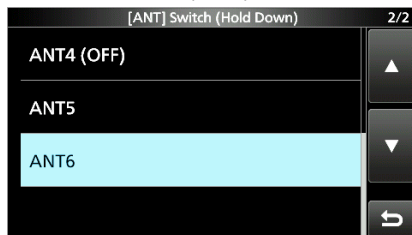

- ① Push **ANT** to return to the original antenna connector.

- ① You can select whether or not to display the Antenna Popup window when changing the antenna connector with the amplifier turned ON. To display the window, select “ON” in the following setting.

MENU » **ANT > Antenna Popup**

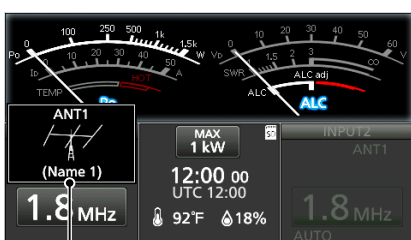

Antenna Popup window

◇ Using the touch screen display

1. Push **ANT**.
 - The ANTENNA SELECT screen is displayed.
2. Touch the desired ANT key (ANT 1 ~ ANT 6).
 - The frame of the selected antenna connector is displayed in blue.

TX/RX side (Example: INPUT 1, ANT 2):

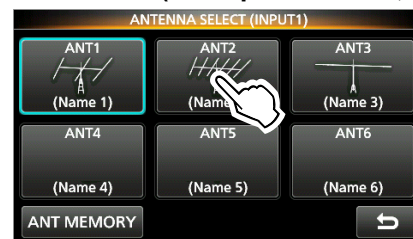

RX side (Example: INPUT 2, ANT 3):

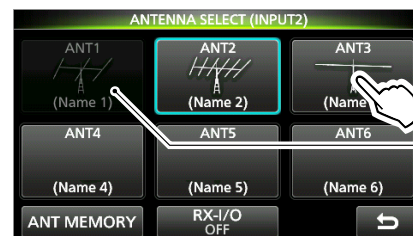

Indicates that the antenna connector cannot be selected

- ① The antenna connector selected on the TX/RX side is grayed out on the RX side's ANTENNA SELECT screen.
- ① When “Connect an Exciter to INPUT1 & 2” is selected in the “Exciter Connection” setting, and the same antenna connector is selected, the RX side is grayed out, and **ANT** or **ANT** is displayed.



4 BASIC OPERATION

ANT key display settings

You can set whether or not to use each ANT key and their names and icons.

1. Push **ANT**.
 - The ANTENNA SELECT screen is displayed.
2. Touch the desired ANT key for 1 second.
 - The ANT SETTINGS screen is displayed.
(Example: ANT 2 SETTINGS screen)

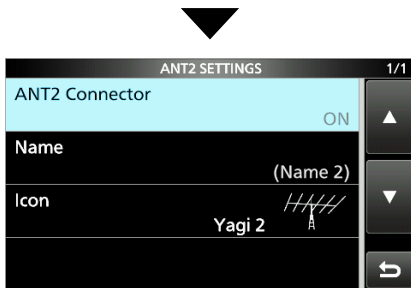
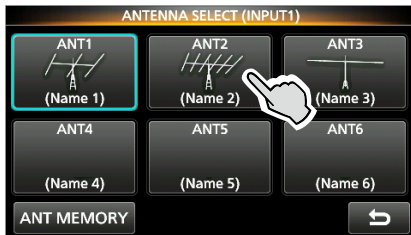

① To display the screen from the Menu screen:

MENU » **ANT > ANT1 Settings** ~
ANT > ANT6 Settings

ANT1 ~ 6 Connector (Default: ON)

Select whether or not to enable the antenna connector.

- OFF: You cannot select the antenna connector.
 - ON: You can select the antenna connector.
- ① The connector set to "OFF" is excluded from the antenna switching by pushing **ANT**, Antenna Memory setting, and the target of the RX-I/O setting, and the ANT key is grayed out.

Name (Default: (Name 1) ~ (Name 6))

Enter the name displayed in the ANT key.

- ① You can enter up to 16 characters.
- ① See page 1-8 for details on entering characters.

Icon (Default: ANT 1: Yagi 1, ANT 2: Yagi 2, ANT 3: Dipole 1, ANT 4 to ANT 6: No Icon)

Select the icon displayed in the ANT key.

- Options:
No icon, Yagi 1, Yagi 2, Vertical 1, Vertical 2, Dipole 1, Dipole 2, Wire Dipole 1, Wire Dipole 2, Wire, Quad, Dummy Load

Antenna memory

This function saves antenna connector settings for each frequency band. You can set antenna connectors (ANT 1 to ANT 6) to the selected bands.

① ANT 1 is set to all frequency bands as the default.

1. Open the ANTENNA MEMORY screen.

MENU » **ANT > Antenna Memory**

① You can also display the screen by touching [ANT MEMORY] in the ANTENNA SELECT screen.

2. Touch the desired key.

- The antenna connector is sequentially changed between ANT 1 and ANT 6.

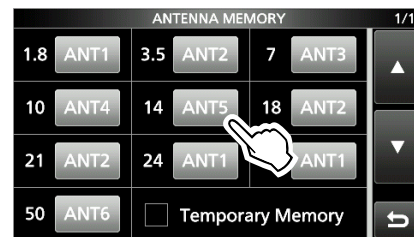

① The antenna connector set to "OFF" in the ANT1 ~ 6 Connector setting cannot be selected.

① When the antenna connector set in the ANTENNA MEMORY screen is changed to "OFF" in the ANT1 ~ 6 Connector setting, the connector set to "ON" will be selected as the connector for that frequency band instead.

① When the same antenna connector is set for both [INPUT 1] and [INPUT 2] in the selected frequency band, the Antenna Memory setting is applied for **INPUT** (Lights orange: TX/RX side).

3. Push **MENU** to exit the ANTENNA MEMORY screen.

When the Temporary Memory function is turned ON (☑):

When the antenna connector different from the Antenna Memory setting is selected (☑ is displayed) and changes to another frequency band, the changed setting will be temporarily saved (except for the RX-I/O setting).

After selecting yet another band, when you return to that band, the temporarily saved connector will be selected.

① The Temporary Memory setting is updated each time the combination of the antenna connector and the frequency band is changed from the Antenna Memory setting.

RX-I/O setting

About the RX side ANT in the Same band TX setting

When “Connect Two Exciters to INPUT1 & 2” or “Connect an Exciter to INPUT 1 & 2” is selected in the “Exciter Connection” setting, and the same frequency band is set to [INPUT 1] and [INPUT 2], the antenna connector selected in **INPUT** (Lights green: RX side) is automatically disconnected from the antenna while transmitting.

This avoids excessive input of the transmitted signal from the receiving antenna.

The connector will be connected to the antenna again 2 seconds after transmission stops.

To connect the antenna even while transmitting in the same band, select “ON” in the following setting.

MENU » **ANT > RX Side ANT in the Same Band TX**

You can set whether or not to output the signal from the receiving antenna to an external device (a preamplifier, a band-pass filter, or an attenuator) connected to [RX-ANT IN] and [RX-ANT OUT].

1. Push **ANT** of **INPUT** (Lights green: RX side).
 - The ANTENNA SELECT screen is displayed.
 2. Touch [RX-I/O (OFF)].
 - “ON” is displayed under “RX-I/O.”
- ① “ON” or “OFF” is switched each time you touch.

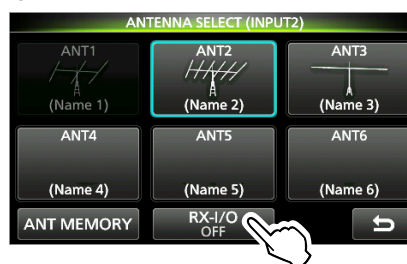

- ① When “ON” is selected, the RX-I/O indicator (Ⓡ) is displayed in the right of the antenna indicator.



- ① The RX-I/O setting is enabled even if the linear amplifier is in the Antenna Selector mode.
- ① The RX-I/O setting is not saved in the Antenna Memory setting.

TIP: Select whether or not to enable the RX-I/O setting for each frequency band:

1. Open the RX-I/O Usable Band screen.

MENU » **ANT > RX-I/O Usable Band**
2. Touch the checkbox of each frequency band, “All ON,” or “All OFF.”
 - When “ON” is selected, is displayed on the selected band.

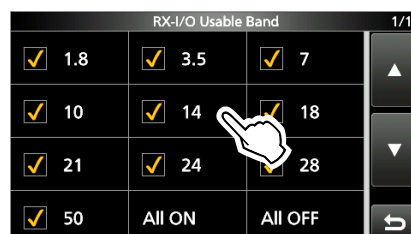

- ① Push **MENU** to exit the RX-I/O Usable Band screen.
- When an option other than “All ON” or “All OFF” is selected, “Custom” is displayed in the RX-I/O Usable Band item.



4 BASIC OPERATION

Meter display

IC-PW2 has 6 different meters.

- **Po:** Displays the relative RF output power.
- **Id:** Displays the drain current of the final amplifier MOS-FETs.
- **TEMP:** Displays the temperature of the PA unit.
- **Vd:** Displays the drain voltage of the final amplifier MOS-FETs.
- **SWR:** Displays the SWR of the antenna at the selected frequency band.
- **ALC:** Displays the ALC level.

Touch the meter display to change the meter type.



Po → Id → TEMP Vd → SWR → ALC

◇ Displaying the Multi-function meter

You can simultaneously display all the parameters.

- Touch the meter display for 1 second to display the Multi-function meter.
 - ① To close the Multi-function again, touch the meter display for 1 second again.

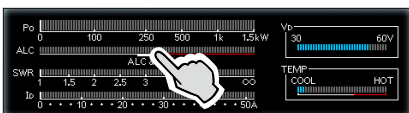

◇ About the HOT zone of the TEMP meter

When the TEMP meter indicates the maximum value of the HOT zone (TX Inhibit Protection zone), the protection circuit is activated, and the linear amplifier circuit is automatically turned OFF. (p. 8-1)

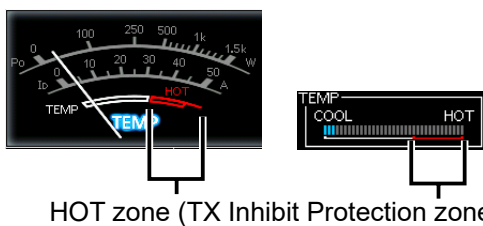

- ① Stop the transmission from the exciter, and **DO NOT** transmit again until the meter is out of the HOT zone.

Confirmation before transmitting

Confirm the following before transmitting from the exciter.

- The antenna is properly tuned.
- When the linear amplifier is used with 180 ~ 264 V AC, it is set to the output power to be used (1 kW or 500 W).
- When an Icom CI-V exciter is connected, the operation frequency and band are synchronized.
- For each output power (1 kW and 500 W), the ALC level is adjusted for the RF input connectors ([INPUT 1] and [INPUT 2]).
- The following settings are properly set.
 - The status of [INPUT 1] and [INPUT 2]
 - The frequency band for [INPUT 1] and [INPUT 2]
 - The linear amplifier circuit is turned ON or OFF
 - The internal antenna tuner is turned ON or OFF
- Check the value of each meter after the last transmission.

Caution for transmission:

DO NOT transmit from the exciter connected to **INPUT** (Lights green: RX side). This could damage the amplifier.

About the internal antenna tuner

The internal antenna tuner automatically matches the linear amplifier to the antenna within the impedance range of 16.7 ~ 150 Ω (VSWR of 3:1 or less).

- To tune at the desired operating frequency, use manual tuning, as explained to the right.
 - After the tuner matches an antenna, the relay combinations are memorized as a preset point.
 - ① The tuning will not start even if the tuner is turned ON by pushing **TUNER** and transmitting from the exciter.
- The ON/OFF setting of the tuner is memorized for each frequency band and each antenna connector (ANT 1 to ANT 6).
 - ① The next time you turn ON the tuner and select the frequency that has been manually tuned, the memorized relay combinations are automatically preset. If the antenna cannot be matched by tuning at the preset point, do the manual tuning steps again.
- Up to 100 tuning relay combinations can be memorized for each antenna connector. When you install a new antenna, or you want to change the antenna settings, you can clear all of the internal antenna tuner preset points with the “<<Tuner Preset Memory Clear>>” item on the FUNCTION screen. (p. 9-1)

MENU » SET > Function > <<Tuner Preset Memory Clear>>

NOTE:

- The exciter’s internal antenna tuner must be turned OFF.
- When a wire antenna cannot be tuned, check the wire length and connection. Note that the IC-PW2 cannot tune a wire that is $\frac{1}{2}\lambda$ long or on a multiple of that frequency.
- When the operating frequency is changed, the antenna must be tuned again.

TIP: Tuning during the Split frequency operation

When the Icom exciter meets all of the following conditions, the amplifier automatically tunes (presets) the antenna on the transmit frequency even if the exciter’s receive frequency is changed by 100 kHz or more.

- “AUTO” is selected in the BAND window.
 - Supports the linked manual tuning.
 - During the Split frequency operation.
 - ① When the exciter meets all of the following conditions, the amplifier automatically presets the antenna on the receive frequency when the exciter’s receive frequency is changed by 100 kHz or more.
 - “CI-V Output (for ANT)*” is set to “OFF,” or does not support the CI-V commands.
 - Connected to **INPUT** (Lights green: RX side).
 - During the Split frequency operation.
- * When an Icom exciter that supports the linked manual tuning is connected, it is automatically set to “ON.”

About manual tuning

You can manually tune the antenna before transmitting.

1. Hold down **TUNER** for 1 second.
 - The indicator on **TUNER** and **TUNE** blink red.
 - “Starts tuning. Start transmitting.” is displayed.
 - ① When an Icom exciter that supports the linked manual tuning is connected, the exciter starts transmitting at the same time.
2. When an exciter that does not support the linked manual tuning is connected, transmit from the exciter connected to **INPUT** (Lights orange: TX/RX side).
 - After tuning, the indicator on **TUNER** lights white, and the internal antenna tuner stays ON.
 - ① Tuning normally takes 2 ~ 3 seconds.
 - ① If “The tuning failed. Stop transmitting.” is displayed, stop the transmission. The indicator on **TUNER** goes out, and the tuning circuit is automatically bypassed.

NOTE:

- **BE SURE** to manually tune when the transmit SWR of the antenna is 1.5:1 or more, even after automatically tuning.
- If the antenna cannot be matched even after manual tuning, check the impedance and antenna SWR.

NOTE: The SD cards and SDHC cards are not available from Icom (User supplied).

TIP: Icom recommends that you save the linear amplifier's factory default data for backup.

About the SD cards

You can use an SD card of up to 2 GB or an SDHC of up to 32 GB. Icom has checked the compatibility with the following SD and SDHC cards.

(As of January 2025)

Brand	Type	Capacity
SanDisk®	SD	2 GB
	SDHC	4/8/16/32 GB

- ① The above list does not guarantee the card's performance.
- ② Throughout the rest of this document, the SD card and SDHC card are called the SD card or the card.

NOTE:

- Before using the SD card, thoroughly read the instructions that came with the card.
- If any of the following occur, the card's data may be corrupted or deleted.
 - You remove the card from the linear amplifier while it is still accessing the card.
 - A power failure occurs, or the power cable is disconnected while accessing the card.
 - You drop, impact, or vibrate the card.
- **DO NOT** touch the contacts of the card.
- The linear amplifier may take longer to recognize a high-capacity card.
- The card has a certain lifetime, so data reading or writing may not be possible after using it for a long period of time. If reading or writing data is impossible, the card's lifetime may have ended. In that case, use a new one. We recommend that you make a separate backup file of the important data on your PC.
- Icom will not be responsible for any damage caused by data corruption on an SD card.

Saving data

You can save the following data onto the card.

- Data settings of the linear amplifier
- Captured screens

Inserting

Insert the SD card as shown below.

- ① Insert the SD card into the slot until it locks in place and makes a 'click' sound.
- ② Be sure to check the SD card orientation before inserting.

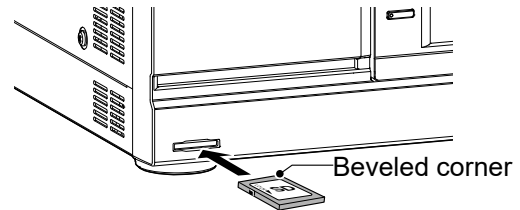

NOTE:

Before using an SD card for the first time, be sure to format it in the linear amplifier.

- Formatting a card erases all its data.
- Before formatting any used card, back up its data onto your PC.
- After inserting or formatting, a special folder on the card that you need for operations like updating the firmware is created.

IMPORTANT: Even if you have formatted an SD card, some data may remain on the card. When you dispose of the card, BE SURE to physically destroy it to avoid unauthorized access to any remaining data.

Formatting

Before using an SD card, format it to be used with the linear amplifier by doing the following steps.

1. Open the SD CARD screen.

MENU » **SET > SD Card**

2. Touch "Format."

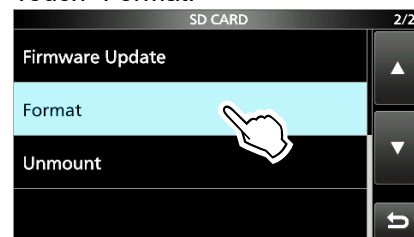

3. Touch [YES] to start formatting.

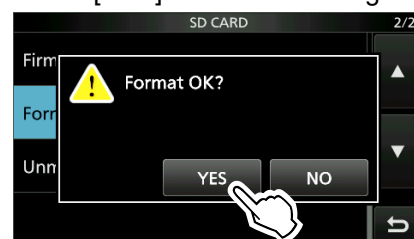

- After formatting, returns to the SD CARD screen.
- ① To cancel formatting, touch [NO].

4. To close the SD CARD screen, push **MENU**.

Unmounting

Before you remove a card when the linear amplifier is ON, be sure to electrically unmount it, as shown below.

Otherwise, the data may be corrupted or deleted.

1. Open the SD CARD screen.

MENU » **SET > SD Card**

2. Touch “Unmount.”

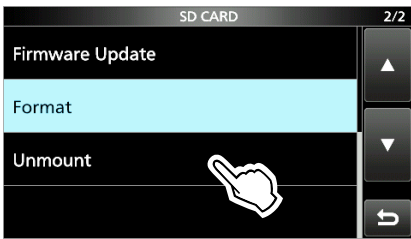

3. Touch [YES] to unmount.

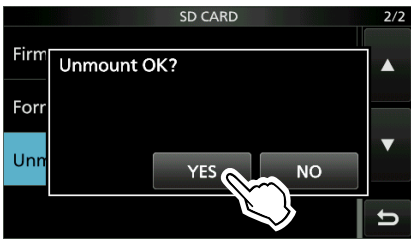

- After unmounting, returns to the SD CARD screen.

① To cancel unmounting, touch [NO].

4. Remove the card from the amplifier.

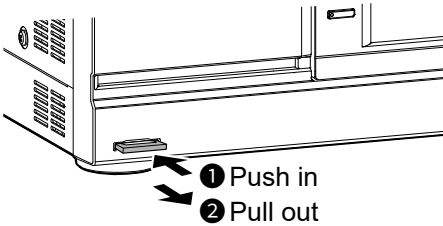

① Push in the card until a 'click' sounds to unlock it, and then pull it out.

5. To close the SD CARD screen, push **MENU**.

When the linear amplifier is OFF

You can remove the card starting from step 4, described above.

Saving the setting data

The linear amplifier's settings can be saved onto an SD card.

1. Open the SAVE SETTING screen.

MENU » **SET > SD Card > Save Setting**

2. Touch “<<New File>>.”

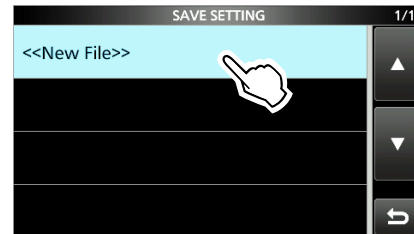

① The file name is automatically set in the following format: Setyyyyymmdd_xx (yyyy: Year, mm: month, dd: day, xx: serial number).

3. To save the file with the displayed name, touch [ENT].

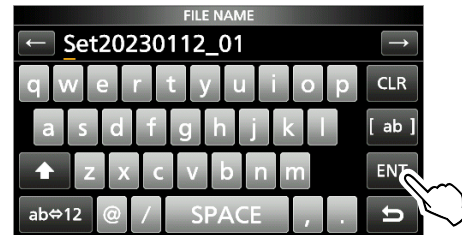

① If you want to change the name, delete and reenter it, and then touch [ENT].

① See page 1-8 for details on entering characters.

4. Touch [YES].

- Saves the data settings.



5. To close the SAVE SETTING screen, push **MENU**.

Loading the saved data

You can load the linear amplifier's settings from the SD card to the amplifier.

① The amplifier has "ALL" and "Select" loading options.

TIP: Saving the current data before loading other data into the amplifier is recommended. (p. 6-2)

1. Open the LOAD SETTING screen.
MENU » SET > SD Card > Load Setting

2. Touch the file to load.

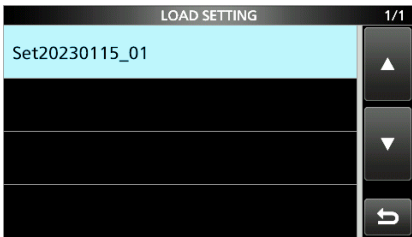

3. Touch "Select."

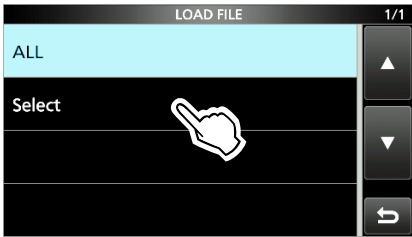

① To load all the contents on the LOAD OPTION screen, touch "ALL" and go to step 6.

4. Touch the loading options.
 (Example: IC-PW2 CI-V Address)

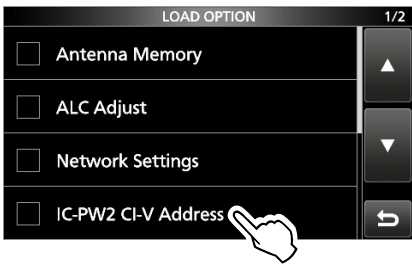

- is displayed on the left side of the selected option.
- ① The "Other Settings & Memories" (settings other than Antenna Memory, ALC Adjust, Network Settings, and IC-PW2 CI-V Address) are always loaded.

5. Touch "<<Load>>."

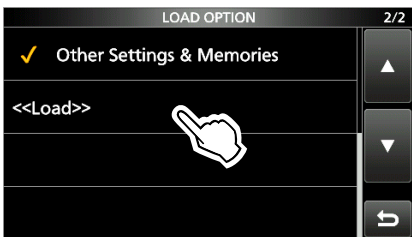

- "Load file?" is displayed.

6. Touch [YES].

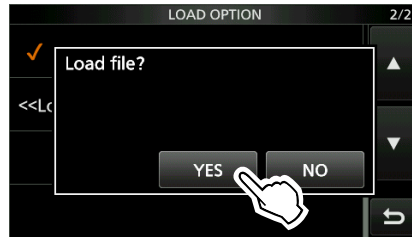

- After the loading ends, "COMPLETED! Restart the IC-PW2." is displayed.
- ① When you select "ALC Adjust" in step 4, "The new "ALC Adjust" setting will be saved" is displayed.

7. Turn OFF the linear amplifier power, and then turn it ON again to restart it.

Deleting a data file

Follow the steps below to delete the files you no longer need on the SD card.

NOTE: Deleted data from a card cannot be recalled. Before deleting any data, back up the card data onto your PC.

1. Open the SAVE SETTING screen.
MENU » **SET > SD Card > Save Setting**
2. Touch the file to delete it for 1 second.

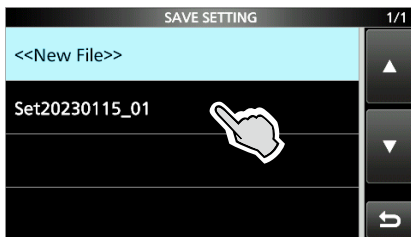

3. Touch "Delete."

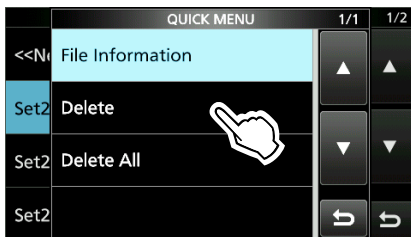

- "Delete file?" is displayed.
- ① To delete all files, touch "Delete All."
- ① To cancel deleting, touch [↵].

4. Touch [YES].

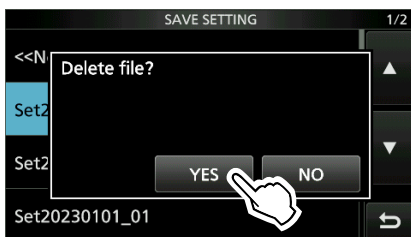

5. To close the SAVE SETTING screen, push **MENU**.

Checking the file information

Touch "File Information" on the QUICK MENU to display the file name, size, and saved date.

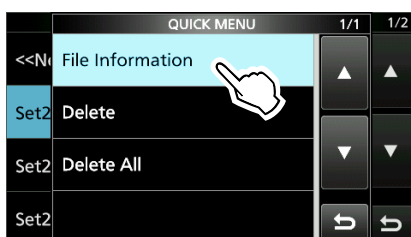

Displaying the SD card information

You can display the SD card capacity.

1. Open the SD CARD screen.

MENU » **SET > SD Card**

2. Touch "SD Card Info."

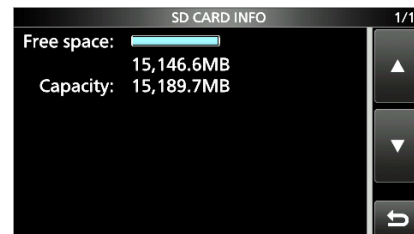
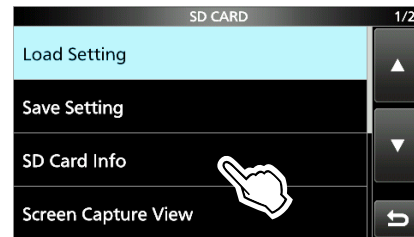

3. To close the SD CARD INFO screen, push **MENU**.

About the SD card's folders

You can easily restore data with a backup file, even if the setting data in the SD card is accidentally deleted.

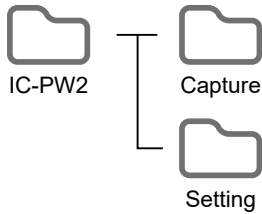

The folder in the SD card contains the following.

- **IC-PW2 folder**
The folders created in the IC-PW2 are contained in this folder.
- **Capture folder**
Saves the captured screen data in the “png” or “bmp” format.
- **Setting folder**
Saves the linear amplifier's setting data in the “icf” format.

The saved data can also be checked by loading the SD card into a PC.

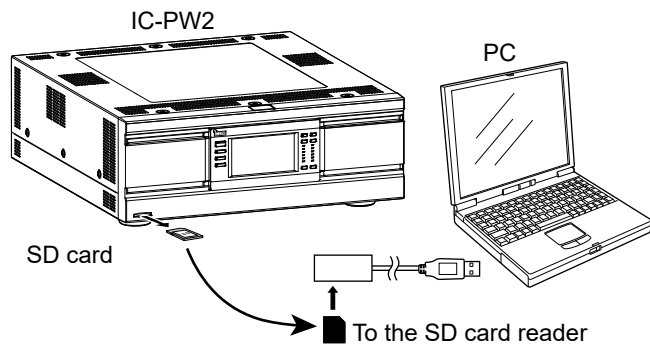

Set mode description

You can use the Set mode to set infrequently changed values or function settings.

1. Push **MENU**.

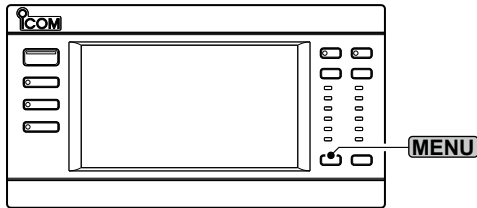

2. Touch [SET].



3. Touch the category that you want to select.

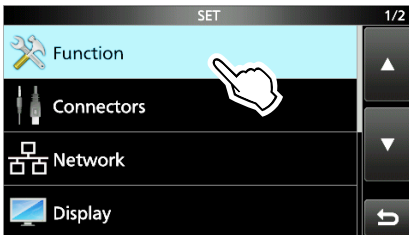

4. Touch [▲] or [▼] to scroll through the items.

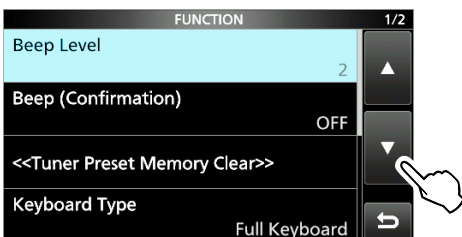

5. Touch the item to open the item's setting screen or to open its next tree level.

① To go back to the previous tree level, push [◀].

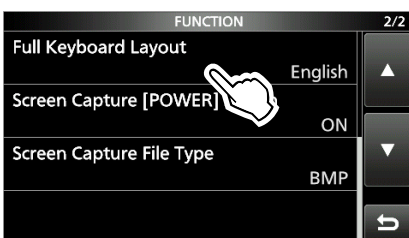

TIP: The Set mode is constructed in a tree structure. You may go to the next tree level or go back to the previous level, depending on the selected item.

6. Touch to select or to set the option.
 - The selected option is set and returns to the previous screen.

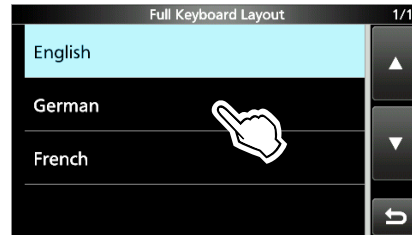

7. To close the SET screen, push **MENU**.

TIP: Resetting to the default setting

1. Push **QUICK** or touch the item for 1 second to display the QUICK MENU screen.
2. Touch "Default" to reset to the default setting.
 - ① To close the QUICK MENU screen, push [◀].

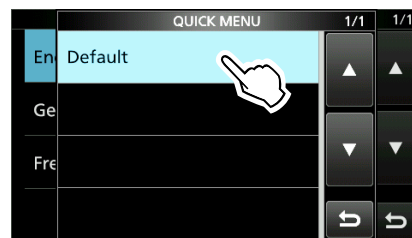

Function

MENU » **SET > Function**

Beep Level (Default: 2)

Sets the beep output level.

- ① If the “Beep (Confirmation)” item is set to “OFF,” no beep sounds.

Beep (Confirmation) (Default: ON)

Turns the Confirmation beep ON or OFF.

- OFF: Turns OFF the function for silent operation.
- ON: A beep sounds when a switch is pushed, or the touch screen is touched.

- ① If “Beep Level” is set to “0,” no beep sounds.

Power ON/OFF Control (Link to Exciter) (Default: OFF)

When connecting the linear amplifier to an Icom exciter with the supplied accessory cable, this item selects whether or not to link the amplifier’s power ON/OFF to the operation of the exciter’s power key.

- OFF: Does not link to exciter power key operation. (Only the Antenna Selector mode is linked)
- ON: Links to exciter power key operation.

- ① Even if “ON” is selected, the amplifier may not be linked to the exciter power key operation immediately after power recovery or connecting the AC power cable.

<<Tuner Preset Memory Clear>>

Deletes the preset point memorized for fast tuning of the selected antenna connector.

- Options: ANT1, ANT2, ANT3, ANT4, ANT5, ANT6, and All

- ① When touching the option, the confirmation dialog is displayed.
- ① To delete all preset points memorized in ANT1 to ANT6, select “All.”
- ① The preset points cannot be deleted by the Partial reset or All reset operations. (p. 9-1)

Keyboard Type (Default: Full Keyboard)

Sets the keyboard entry type to Ten-Key or Full Keyboard.

- ① You can also select the Full Keyboard or Ten-key by pushing **QUICK** while displaying an entry mode screen.

Full Keyboard Layout (Default: English)

Selects the on-screen keyboard layout from English, German, and French.

Screen Capture [POWER] Switch (Default: OFF)

Assigns the Screen Capture function to **POWER**.

- OFF: **POWER** does not act as the Screen Capture key.
- ON: The display screen is saved to the inserted SD card by pushing **POWER**.

Screen Capture File Type (Default: PNG)

Sets the format for the Screen Capture function to PNG or BMP.

Connectors

MENU » **SET > Connectors > Selected BAND Output**

Selected BAND Output (BAND 1)

Sets the band voltage output from [BAND 1] to control an external device (band-pass filter, band decoder, and so on).

Output Type (Default: INPUT1)

Sets the signal line that outputs the band voltage.

- INPUT1: The band voltage on [INPUT 1] is output.
- INPUT2: The band voltage on [INPUT 2] is output.
- TX Side: The band voltage on the TX/RX side (**INPUT**: Lights orange) is output.
- RX Side: The band voltage on the RX side (**INPUT**: Lights green) is output.

Output Level (Default: ON: Low, OFF: Open)

Sets the band voltage output condition.

- ON: Low, OFF: Open: Sets the terminal of the band to be used to Low (Shorted) and the terminal of the band not to be used to Open.
- ON: 12V, OFF: Low: Sets the terminal of the band to be used to 12 V (High) and the terminal of the band not to be used to Low (Shorted).
- ① When the linear amplifier is in the Antenna Selector mode, the terminal of the band to be used will be set to Open.

Selected BAND Output (BAND 2)

Sets the band voltage output from [BAND 2] to control an external device (band-pass filter, band decoder, and so on).

Output Type (Default: INPUT2)

Sets the signal line that outputs the band voltage.

- INPUT1: The band voltage on [INPUT 1] is output.
- INPUT2: The band voltage on [INPUT 2] is output.
- TX Side: The band voltage on the TX/RX side (**INPUT**: Lights orange) is output.
- RX Side: The band voltage on the RX side (**INPUT**: Lights green) is output.

Output Level (Default: ON: Low, OFF: Open)

Sets the band voltage output condition.

- ON: Low, OFF: Open: Sets the terminal of the band to be used to Low and the terminal of the band not to be used to Open.
- ON: 12V, OFF: Low: Sets the terminal of the band to be used to 12 V (High) and the terminal of the band not to be used to Low.
- ① When the linear amplifier is in the Antenna Selector mode, the terminal of the band to be used will be set to Open.

MENU » **SET > Connectors > CI-V**

CI-V Address (Default: AAh)

Sets the CI-V address for remote control of the linear amplifier.

REMOTE AUX CI-V Baud Rate (Default: Auto)

Selects the data transfer speed for an external device (an antenna rotator controller, a band decoder, and so on) connected to [REMOTE AUX] when remotely controlling the device or the linear amplifier using CI-V commands.

① When "Auto" is selected, the baud rate is automatically set according to the data rate of the connected device.

REMOTE AUX CI-V Output Select (Default: INPUT1/2)

When "Connect Two Exciters to INPUT1 & 2" or "Connect an Exciter to INPUT1 & 2"* is selected in the "Exciter Connection" setting (p. 3-1), the status of the RF input connector set in this item (frequency on **INPUT** (Lights orange: TX/RX side) and so on) is output to [REMOTE AUX].

- INPUT1: Outputs the status of [INPUT 1] regardless of which RF input connector is set to the TX/RX side.
- INPUT2: Outputs the status of [INPUT 2] regardless of which RF input connector is set to the TX/RX side.
- INPUT1/2: Outputs the status of the RF input connector set to the TX/RX side.

* When "Connect an Exciter to INPUT1 & 2" is selected in the "Exciter Connection" setting and the same antenna connector is selected, the amplifier operates with the "INPUT1/2" setting.

REMOTE AUX CI-V Transceive (Default: ON)

Turns the REMOTE AUX CI-V Transceive function ON or OFF.

REMOTE AUX CI-V Output (for ANT) (Default: OFF)

Enables outputting the linear amplifier status (frequency on **INPUT** (Lights orange: TX/RX side) and so on) from [REMOTE AUX] to an external device.

MENU » **SET > Connectors**

INPUT1/2 Selection Input

(Default: INPUT1 : (1) Low, (2) Open)

Sets the switching operation between [INPUT 1] and [INPUT 2] according to the signal (Low or Open) input from the external device connected to the [INPUT 1/2] jack.

- INPUT1:(1) Low, (2) Open
2:(1) Open, (2) Low
- INPUT1:(1) Open, (2) Low
2:(1) Low, (2) Open

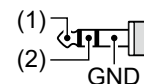

- INPUT1:(1) Low
2:(1) Open
- INPUT1:(1) Open
2:(1) Low

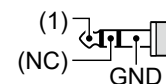

① The status of [INPUT 1] and [INPUT 2] (TX/RX side, RX side, or OFF) are switched by the combination of signals (Low and Open) input to (1) and (2) or only (1).

① When the setting is to use only (1) or while the signal is being input when both (1) and (2) are set to be used, the switching operation by pushing **INPUT** cannot be performed.

Network

MENU » **SET > Network**

DHCP (Valid after Restart) (Default: ON)

Turns the DHCP function ON or OFF.

- OFF: Uses a static IP address.
- ON: Uses the DHCP function.
If a DHCP server is in your network environment, the IP address is automatically obtained.

IP Address (Valid after Restart) (Default: 192.168. 0. 10)

Sets the static IP address.

Subnet Mask (Valid after Restart) (Default: 255.255.255. 0 (24 bit))

Sets the subnet mask to connect to your PC or Local Area Network (LAN), through the Ethernet.

Default Gateway (Valid after Restart) (Default:)

Sets the Default Gateway of the IC-PW2. If you are operating the IC-PW2 using the optional remote control software*, a default gateway setting is required.

* Future product, as of January 2025.

Primary DNS Server (Valid after Restart) (Default:)

Enter the primary DNS server address.

2nd DNS Server (Valid after Restart) (Default:)

If there are 2 DNS server addresses, enter the secondary DNS server address.

Network Name

If you are operating the IC-PW2 using the optional remote control software*, enter a name of up to 15 characters.

* Future product, as of January 2025.

① See page 1-8 for details on entering characters.

Display

MENU » **SET > Display**

LCD Backlight (Default: 50%)

Sets the LCD backlight brightness.

LED Bright (Default: 80%)

Sets the LED brightness.

Meter Response (Default: Mid)

Sets the meter needle response speed to Slow, Mid, or Fast.

Meter Peak Hold (Default: ON)

Turns the Meter Peak Hold function ON or OFF.

① When the function is turned ON, the indicated value at the time of the largest swing when using the multi-function meter is held for 0.5 seconds.

Screen Saver (Default: 60min)

Sets the Screen Saver function.

① When no operation is performed for the preset period of time, the screen is automatically turned OFF, and the indicator on **POWER** blinks blue.

To display the screen, push any key or touch the screen.

Opening Message (Default: ON)

Selects whether or not to display the opening message at power ON.

My Call

Displays text as the opening message, up to 10 characters. (p. 8-4)

Temperature Unit (Default: °F)

① The default value differs, depending on the linear amplifier version.

Select the format to display the temperature.

Display Language (Default: English)

Set the screen display language type to English or Japanese.

① This item is displayed only when the "System Language" item is set to "Japanese."

System Language (Default: English)

Set the system language of the linear amplifier.

- English: The system language of the amplifier is English.
Only alphabetical characters (A to Z, a to z, 0 to 9) and symbols (! " # \$ % & ' () * + , - . / : ; < = > ? @ [\] ^ _ ` { | } ~) can be displayed. If Japanese characters (Kanji, Hiragana, and Katakana) are included, the display shows “=” or “_” instead of that character. In that case, you can only delete “=” or “_” in the amplifier’s edit mode.
- Japanese: The system language of the amplifier is Japanese.
Kanji, Hiragana, and Katakana characters and the 2-bytes symbols can be displayed. To display such characters in the Menu screen, set “Display Language” to “Japanese.”

① When this item is set to “English,” the “Display Language” item is not displayed.

When you set the system language of the linear amplifier to Japanese, the amplifier has the capability to display both English and Japanese characters. However, if you select Japanese, all menu items throughout the amplifier system will be displayed only Japanese characters. There will be no English item names. Unless you are fluent in reading Japanese characters, use this feature with extreme caution. If you have changed the amplifier’s language to Japanese and do not understand the menu system in the new setting, you will have to change the language back to English by doing a partial reset of the amplifier CPU. A partial reset will not clear your call sign databases.

To do a partial reset of the CPU, do the following steps:

1. Push **MENU**.
2. Touch [SET].
3. Touch the item (with the “etc.” icon) shown below.



4. Touch the bottom item shown below.



5. Touch the upper item shown below.



6. Touch the left item.

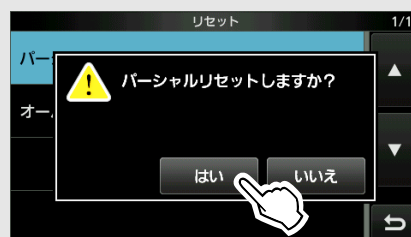

- The amplifier displays “PARTIAL RESET,” and the partial reset is completed.

Time Set

MENU » SET > Time Set > Date/Time

Date

Sets the date (Year/Month/Day).

① The day of the week is automatically set.

Time

Sets the current time.

① The time is displayed in the 24-hour format.

NOTE: The backup battery for the internal clock

The IC-PW2 has a lithium backup battery (CR2032) for the internal clock and timer functions.

When the backup battery is exhausted, the linear amplifier normally works but cannot retain the current time.

See page 9-3 for the battery replacement.

<<NTP TIME SYNC>>

Synchronizes the internal clock with a time management server.

① To use this function, you need an Internet connection and default gateway settings.

NTP Function (Default: ON)

Automatically obtains the current time from an NTP server.

NTP Server Address (Default: time.nist.gov)

Sets NTP server address.

① See page 1-8 for details on entering characters.

MENU » SET > Time Set

UTC Offset (Default: ± 0:00)

Sets the UTC offset time.

CLOCK2 Function (Default: ON)

Displays the second clock on the screen.

CLOCK2 UTC Offset (Default: ± 0:00)

Sets the time offset for Clock 2.

CLOCK2 Name (Default: UTC)

Sets the name of up to 3 characters for Clock 2.

① See page 1-8 for details on entering characters.

SD Card

MENU » SET > SD Card

Load Setting

Selects the saved data file to load.

① See page 6-3 for details.

Save Setting

Saves the setting data onto an SD card.

① See page 6-2 for details.

Save Form (Default: Now Ver)

Selects the format to save the settings onto an SD card.

- Now Ver: Saves the settings in the current version format.
- Old Ver (x.xx - x.xx): Saves the settings in the older version format indicated in the parenthesis (x.xx = version).

① If you select "Old Ver (x.xx - x.xx)," a function that is added when the linear amplifier's firmware format is updated will not be saved.

① You cannot load a setting file that is saved in the current version format to an earlier firmware version.

SD Card Info

Displays the SD card capacity.

Screen Capture View

Displays the selected screen capture.

① See page 8-3 for details.

Firmware Update

Displays the Firmware Update mode.

Format

Formats the SD card.

If you use a brand-new SD card, be sure to format it in the linear amplifier.

① See page 6-1 for details.

Unmount

Unmounts the SD card.

Before you remove a card when the linear amplifier is ON, BE SURE to electrically unmount it. Otherwise, the data may be corrupted or deleted. (p. 6-2)

Others

MENU » SET > Others > **Information**

Version

Displays the linear amplifier firmware's version number.

MAC Address

Displays the linear amplifier's MAC address.

MENU » SET > **Others**

Touch Screen Calibration

Touch to adjust the touch screen.

① See page 9-2 for details.

MENU » SET > Others > **Reset**

Partial Reset

Resets operating settings to their default values (Frequency band, menu contents, and so on) without clearing the items below:

- Antenna memory contents
- The ON/OFF setting of the internal antenna tuner
- Preset points for fast tuning
- Network settings
- My Call setting
- ANT key display settings
- RX-I/O setting for each frequency band
- ALC adjustment contents

① See page 9-1 for details.

All Reset

Clears all data except the preset points for fast tuning and returns settings to their factory defaults.

① See page 9-1 for details.

Protection function

The Protection function monitors errors and load status during operation.

If an abnormality occurs, the protection circuit turns OFF the linear amplifier circuit to protect the linear amplifier.

When the protection circuit is activated:

- Short beeps repeatedly sound.
- The indicator on **PROTECT** lights red.
- The meter display switches to a meter that indicates abnormal values.
- The meter name indicator and protection readout blink.

Example: When “PROTECT: TEMP” is activated.



Blinking the protection readout (PROTECT: TEMP) in red.

The meter display is switched to “TEMP” and the meter name indicator is blinking.

- Stop transmission from the exciter and solve the problem, and then push **PROTECT**.
 - When the problem is solved, a long beep sounds and the indicator on **PROTECT** goes out.
- ① When the problem is not solved, short beeps sound.
- ① When the protection circuit is activated, any operation other than switching the meter and pushing **POWER**, **PROTECT**, **MENU**, and **QUICK** cannot be performed.
- ① Even if the Lock function is turned ON, the protection circuit can be deactivated by pushing **PROTECT** when the exciter is not transmitting.

◇ About the cooling fan

A total of 5 cooling fans are built in, 2 for the power supply unit and 3 for the RF circuit.

- The cooling fans for the power supply unit continuously run when the linear amplifier is turned ON.

The rotation speed of the cooling fans changes according to the temperature inside the power supply unit.
- The rotation speed of the cooling fans for the RF circuit changes according to the indicated value of the TEMP meter. Therefore, the cooling fans start running shortly after transmission starts.

◇ Types of the Protection function

PROTECT: TEMP

Cause:

The temperature of the PA unit has risen to a temperature that requires protection.

- The meter name indicator “TEMP” blinks, and the linear amplifier circuit is turned OFF.

Solution:

- Stop transmitting, and then wait until the protection circuit is automatically deactivated.
- Check for the following problems:
 - Temperatures below -10°C ($+14^{\circ}\text{F}$) or above $+40^{\circ}\text{C}$ ($+104^{\circ}\text{F}$).
 - The cooling vents of the amplifier are clogged with dust.
 - The amplifier is on or too close to the wall.
 - Objects are placed on the amplifier’s sides, top, or rear.

PROTECT: ALC

Cause:

The ALC control voltage exceeds the specified value.

- The meter name indicator “ALC” blinks, and the linear amplifier circuit is turned OFF.

Solution:

Check for the following problems, and then adjust the ALC level.

- The exciter microphone gain and drive gain exceed the ALC zone.
- The antenna SWR is more than 5:1.
- The amplifier has been used for a long time without an ALC adjustment.
- The exciter or antenna has been changed or newly installed.
- When the amplifier is connected to a 180 ~ 264 V AC power source, the ALC adjustment at 500 W is not completed.

PROTECT: POWER

Cause:

The exciter’s output power is too high.

- The meter name indicator “Po” blinks, and the linear amplifier circuit is turned OFF.

Solution:

Adjust the output power to between 100 W and 200 W.

- ① If the problem is not solved with a correct transmit output adjustment, a lower gain may be detected due to a failure of the final stage amplifier.

Contact your nearest Icom Dealer or Service Center.

PROTECT: BAND**Cause:**

Transmitted from the exciter while the frequency of the exciter and the frequency band of the amplifier are different.

- The meter name indicator “Po” blinks, and the linear amplifier circuit is turned OFF.

Solution:

Check for the following problems:

- The frequency band is not synchronized with an Icom exciter.
 - ① When the frequency band is synchronized, “AUTO” is displayed under the frequency button.
- The operating band of the amplifier is the same as the exciter’s transmit frequency.

PROTECT: POWER SUPPLY**Cause:**

- An abnormal signal is detected from the power supply unit.
- The output voltage of the AC power supply section exceeds the specified value.
- There is an abnormality in the drain voltage or current of the power amplification FET.
 - The meter name indicator “ID” and “VD” blink, and the linear amplifier circuit is turned OFF.

Solution:

The power supply unit may be malfunctioning. Contact your nearest Icom Dealer or Service Center.

Clock and timers**◇ Setting the date**

1. Display the DATE/TIME screen.

MENU » **SET > Time Set > Date/Time**

2. Touch “Date.”
 - Displays the date editing screen.
3. Touch [+] or [-] to set the date.
4. Touch [SET] to set the date.

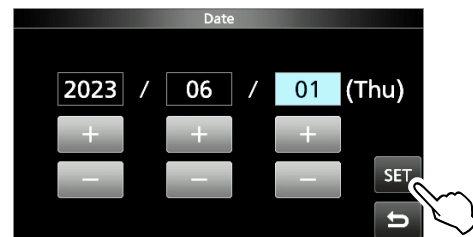

- Returns to the previous screen.
- ① To cancel the editing, touch [↶].

◇ Setting the current time

1. Display the DATE/TIME screen.

MENU » **SET > Time Set > Date/Time**

2. Touch “Time.”
 - Displays the time editing screen.
3. Touch [+] or [-] to set the current time.
4. Touch [SET] to set the time.

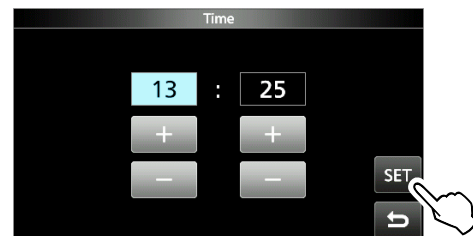

- Returns to the previous screen.
- ① To cancel the editing, touch [↶].

NTP function

The NTP (Network Time Protocol) function synchronizes the internal clock with a time management server.

① To use this function, an internet connection and default gateway settings are necessary.

◇ Using the NTP Time Synchronize function

Using this function, you can manually synchronize the internal clock by accessing a time management server.

1. Display the DATE/TIME screen.
2. Touch “<<NTP TIME SYNC>>.”

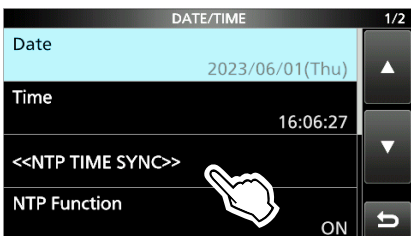

- “NTP Time Sync. Please wait...” is displayed.
 - The linear amplifier starts accessing the NTP server address set in the “NTP Server Address” item. (p. 7-6)
3. When “Time Sync completed.” is displayed, touch [OK].
 4. To close the DATE/TIME screen, push **MENU**.

◇ Using the NTP function

By turning ON the NTP function, the linear amplifier automatically synchronizes the internal clock with a time management server.

1. Display the DATE/TIME screen.
2. Touch “NTP Function.”

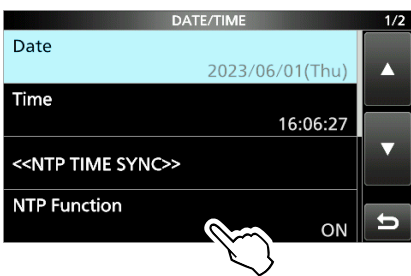

3. Select “ON” or “OFF.”
 - When ON is selected, the linear amplifier starts accessing the NTP server address in the “NTP Server Address” item. (p. 7-6)
4. To close the DATE/TIME screen, push **MENU**.

Screen Capture function

You can capture the linear amplifier display onto an SD card. Most of the screens used in this manual are captured using this function. However, some displays cannot be captured.

◇ Setting the Screen Capture function

1. Open the “Screen Capture [POWER] Switch” screen.
 - MENU** » SET > Function > Screen Capture [POWER] Switch
2. Select “ON.”
 - ① To close the SET screen, push **MENU**.

◇ Capturing a screen

1. Select the desired screen to capture.
 - The captured screen is saved onto the SD card.
 - ① See page 7-2 for changing the file format.
2. Push **POWER** to capture the screen.

◇ Viewing the captured screen

1. Open the SCREEN CAPTURE VIEW screen.
 - MENU** » SET > SD Card > Screen Capture View
 - The capture list is displayed.
 - The latest screen capture is at the top of the list.
2. Touch the desired screen capture.
 - The screen capture is displayed.

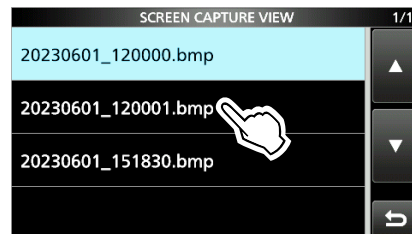

① Touch the screen to back to the SCREEN CAPTURE VIEW screen.

Other options in the capture list

1. While the capture list is displayed, push **QUICK** to display the QUICK MENU screen.

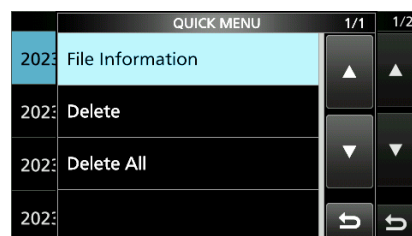

2. Select the desired option.
 - **File Information:** Displays the selected screen capture’s name, size, and date.
 - **Delete:** The confirmation dialog is displayed before deleting the file. Select [YES] to delete or select [NO] to cancel.
 - **Delete All:** The confirmation dialog is displayed before deleting all the files on the list. Select [YES] to delete or select [NO] to cancel.

Displaying my call sign

You can set to display your own call sign at power ON.
(Example: displaying the call sign JA3YUA)

1. Display the MY CALL screen.
MENU » **SET > Display > My Call**
2. Enter "JA3YUA."
 ① You can enter up to 10 characters.
 ① See page 1-8 for details on entering characters.
3. Touch [ENT] to set the call sign.
 • Returns to the previous screen.

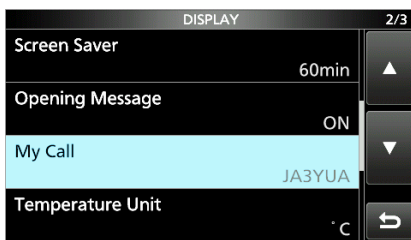
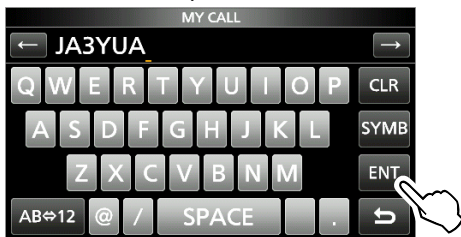

4. To close the DISPLAY screen, push **MENU**.

Digital Pre-Distortion (DPD) function

A digital circuit compensating for distortion, including that generated by the RF power amplifier, reduces distortion in radio waves transmitted by an Icom exciter that supports the Digital Pre-Distortion (DPD) function.

◇ Connecting with the Icom exciter

To use the DPD function, the following connection is additionally required when an Icom exciter is connected (p. 2-4).

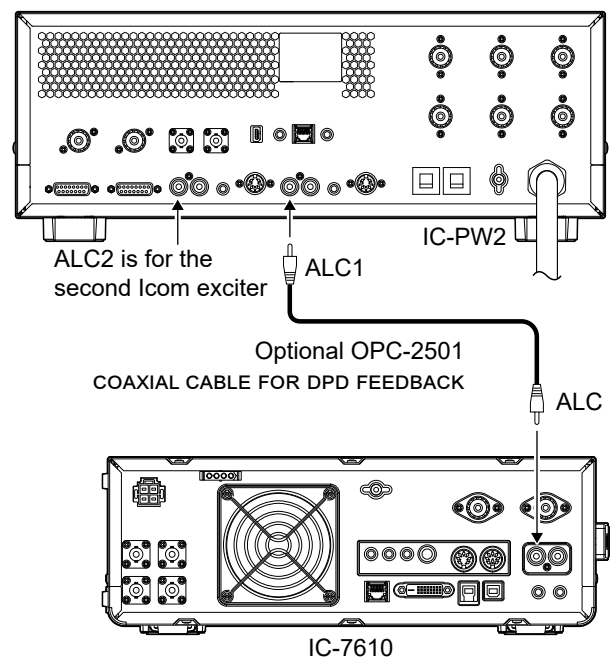

① Information

- To connect the amplifier and an Icom exciter, the optional OPC-2501 must be used.
- When 1 Icom exciter is connected to [INPUT 1] and [INPUT 2], connect to [ALC 1].
When 2 Icom exciter is connected to [INPUT 1] and [INPUT 2], connect each exciter to [ALC 1] and [ALC 2].
- The DPD function does not work with an Icom exciter that does not support the function or a non-Icom exciter.

◇ The DPD adjustment and operation

The DPD adjustment cannot be performed on the Icom exciter until the ALC adjustment (p. 3-3) is completed on the amplifier that the exciter is connected to.

After the DPD linked adjustment with the amplifier is completed on the Icom exciter, and the exciter's DPD function is turned ON, the function will work synchronized with the amplifier.

- ① See the exciter's instruction manual for the DPD adjustment and operation that must be performed on the exciter.

Resetting

Occasionally, erroneous information may be displayed. This may be caused by static electricity or by other factors.

If this problem occurs, turn OFF the linear amplifier. After waiting a few seconds, turn ON the amplifier again.

If the problem still exists, perform a Partial reset, as described to the right.

If the problem still exists after a Partial reset, perform an All reset, also described to the right.

NOTE: An All reset clears all data and returns all settings to factory defaults. Save antenna memory contents, setting status, and so on, onto an SD card before an All reset. (p. 6-2)

Partial reset

Partial reset resets operating settings to their default values (Frequency band, menu contents, and so on) without clearing the items listed below:

- Antenna memory contents
- The ON/OFF setting of the internal antenna tuner
- Preset points for fast tuning
- Network settings
- My Call setting
- ANT key display settings
- RX-I/O setting for each frequency band
- ALC adjustment contents

All reset

All reset clears all data and returns all settings to their factory defaults.

Antenna memory contents, Tuner memory contents, and so on will all be cleared, so you will need to rewrite your operating settings unless you have a backup.

TIP:

- To delete all the preset points for fast tuning, do it from the following item.

MENU » **SET > Function > <<Tuner Preset Memory Clear>>**

- If a touch screen operation error or an unexpected operation occurs, you cannot enter the Set mode. In this case, execute an All reset, as described below:

1. Turn OFF the linear amplifier.
2. While holding down **MENU** and **PROTECT**, push **POWER**.

- ① If you cannot turn the linear amplifier ON or OFF by using **POWER**, perform an All reset by connecting an AC power cable while holding down **MENU** and **PROTECT**.

◇ Partial reset

1. Open the RESET screen.
MENU » **SET > Others > Reset**
2. Touch “Partial Reset.”
• The confirmation screen is displayed.

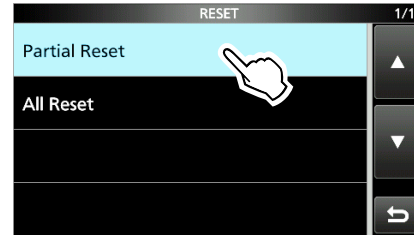

3. Touch [YES].
① After resetting, the Main screen is displayed.

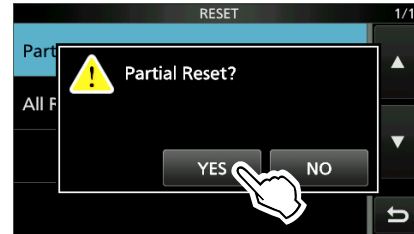

◇ All reset

1. Open the RESET screen.
2. Touch “All Reset.”

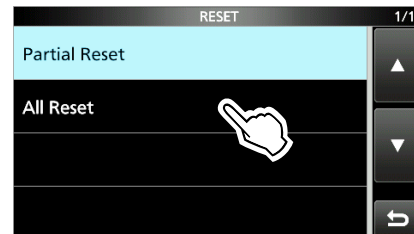

3. Touch [NEXT].

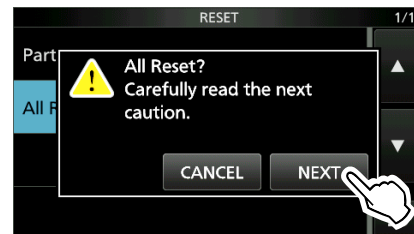

4. After carefully reading the displayed message, touch [YES] to perform the All reset.
① After resetting, the Main screen is displayed.

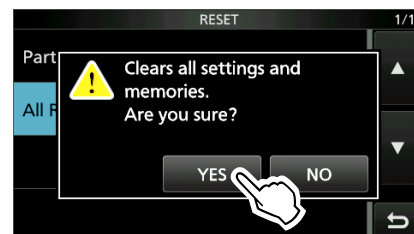

Touch screen calibration function

When no screen action occurs, or a different function is activated after touching the screen, the touched and detected points may differ. In that case, the Touch screen calibration function helps to correct the touch screen sensing accuracy.

1. Open the OTHERS screen.

MENU » **SET > Others**

2. Touch "Touch Screen Calibration."
 - A dot appears on the screen.

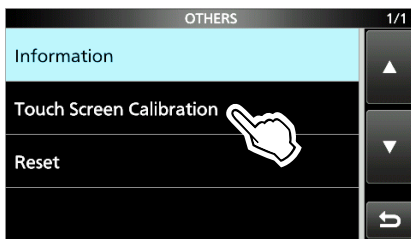

3. Touch the dot displayed on the screen.
 - A new dot appears in another position.

Touch the displayed dot

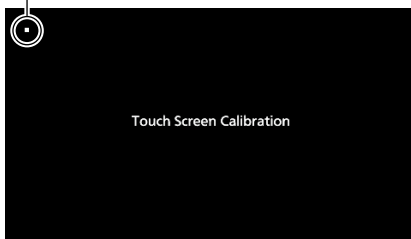

4. Repeat step 3.
 - ① When the calibration is complete, the linear amplifier returns to the OTHERS screen.

TIP: When the touch screen is not accurate, and you cannot access the OTHERS screen.

Do the following steps to display the "Touch Screen Calibration" screen.

1. Turn OFF the linear amplifier.
2. While holding down **MENU** and **QUICK**, push **POWER** to display the "Touch Screen Calibration" screen.
3. Repeat steps 3 and 4 in the above column.
4. Touch the frequency band button or a meter display on the touch screen to confirm that the touch screen is correctly working.

Cleaning



DO NOT use harsh solvents such as benzene or alcohol when cleaning, because they will damage the linear amplifier surfaces.



If the linear amplifier becomes dusty or dirty, wipe it clean with a dry, soft cloth.

Clock backup battery replacement

The IC-PW2 has a lithium backup battery (CR2032) for the internal clock and timer functions. When the backup battery is exhausted, the linear amplifier normally works but cannot retain the current time.

⚠ WARNING! DISCONNECT the AC power cable from the outlet before removing the amplifier's cover.

⚠ WARNING! NEVER replace the battery immediately after turning OFF the linear amplifier. The amplifier may be hot.

1. Remove the 12 screws, and then remove the top cover, as shown in ①.
2. While lightly lifting the metal fitting (+ terminal) of the battery holder in the direction of ①, remove the old battery in the direction of ②, as shown in ②.
 - ① When you cannot remove the battery with your fingers, use a thin, non-metallic stick, such as a toothpick.

CAUTION: DO NOT use metal objects, such as a tweezer. This could damage the linear amplifier.

3. While lightly placing the new battery in the direction of ③, push it into the battery holder, as shown in ②.
4. Return the top cover to the original position, and then connect the AC power cable to the outlet.
 - ① Also, return the 6 washers to their original position, as shown in ①.
5. Turn ON the amplifier, and then set the date and time in the DATE/TIME screen. (p. 8-2)

CAUTION: Always have 2 people carry, lift, or turn over the amplifier.

For Users in California (U.S.A.)

This CR2032 Lithium Battery contains Perchlorate Material—special handling may apply. See <https://dtsc.ca.gov/perchlorate/>

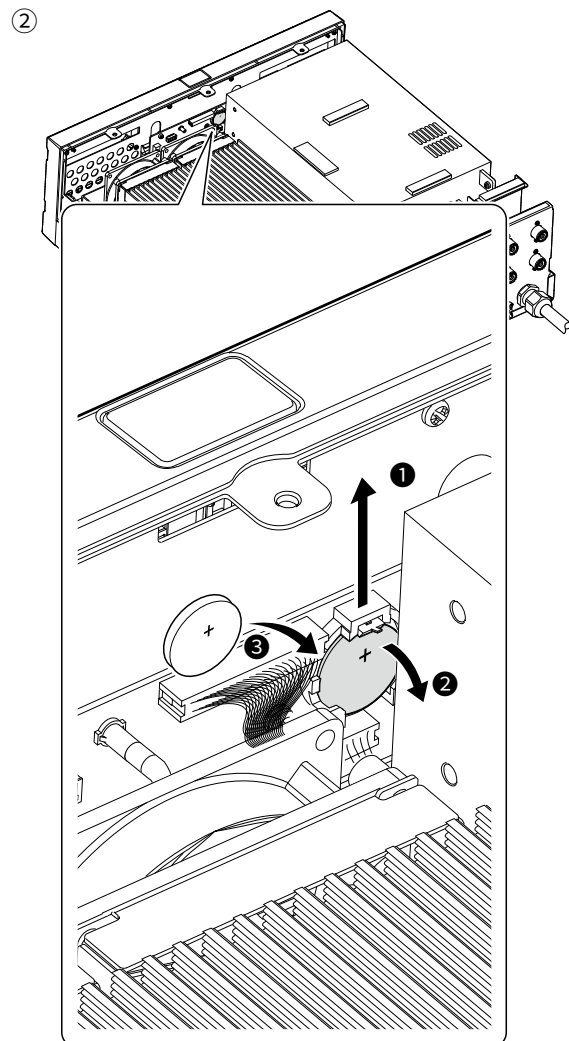
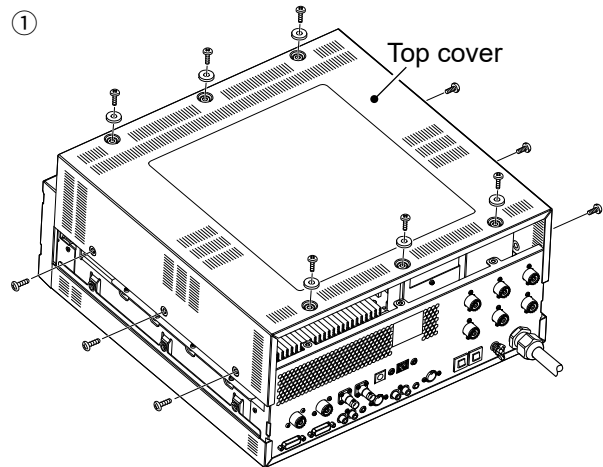

Troubleshooting

The following chart is designed to help you solve problems that are not equipment malfunctions. If you are unable to locate the cause of a problem or solve it through the use of this chart, contact your nearest Icom Dealer or Service Center.

Problem	Possible cause	Solution	REF.
The power does not turn ON when POWER is pushed.	The AC power plug (User supplied) is not properly connected to the AC power cable.	Reconnect the AC power plug to each wire of the AC power cable.	p. 2-3
	The circuit breakers are turned OFF.	Find and repair the cause of the problem, and then push the breakers until it makes a 'click' sound.	p. 1-3
	The controller is not properly attached to the main unit.	Detach and attach the controller again.	p. 2-1
	When the controller is attached to the main unit: There is a bad connection between the back of the panel and the main unit.	Check and clean each terminal.	—
	When the controller is separated from the main unit: There is a bad connection between the control cable.	Check the terminals of the cable.	p. 2-2
You cannot select the Antenna Selector mode.	The exciter's power is turned OFF.	Turn ON the exciter's power.	—
	When an Icom exciter is connected, there is a bad connection with the accessory cable.	<ul style="list-style-type: none"> Connect the cable to [ACC 1] or [ACC 2]. Check the terminals of the cable. 	pp. 2-4 ~ 2-7
	When a non-Icom exciter is connected, 13.8 V DC is not supplied to [ACC 1] or [ACC 2].	Supply 13.8 V DC to [ACC 1] or [ACC 2] using a DIN connector.	pp. 2-7, 2-8
The operating frequency and band are not synchronized with an Icom exciter.	There is a bad connection with the remote control cable.	<ul style="list-style-type: none"> Connect the cable to [REMOTE 1] or [REMOTE 2]. Check the terminals of the cable. 	pp. 2-5 ~ 2-7
	There is a bad connection with the accessory cable.	<ul style="list-style-type: none"> Connect the cable to [ACC 1] or [ACC 2]. Check the terminals of the cable. 	pp. 2-5 ~ 2-7
	The exciter firmware is not the latest version.	Update to the latest version.	pp. 10-1 ~ 10-3
	The option of the "Exciter Connection" setting is different from the exciter connection pattern.	Set the appropriate option in the "Exciter Connection" setting.	p. 3-1
	The "IC-PW2 Dual Connection Mode" setting of the Icom exciter is different from the linear amplifier's connection mode.	<ul style="list-style-type: none"> When "Connect an Exciter to INPUT1 & 2" is selected in the "Exciter Connection" setting, select "ON" in the IC-PW2 Dual Connection Mode setting of the Icom exciter. When an option other than "Connect an Exciter to INPUT1 & 2" is selected in the "Exciter Connection" setting, select "OFF" in the IC-PW2 Dual Connection Mode setting of the Icom exciter. 	See the exciter's instruction manual for details.
	The CI-V address or baud rate, the same as the exciter, is not set to [INPUT 1] or [INPUT 2].	Set the same CI-V address or baud rate as the exciter.	p. 3-2
	Multiple external devices, including the amplifier, are connected to the exciter.	Remove any external devices other than the amplifier from the exciter.	p. 3-1

9 MAINTENANCE

Troubleshooting

Problem	Possible cause	Solution	REF.
The operating frequency and band are not synchronized with an Icom exciter.	The band signal from the exciter is not received.	After reconnecting the remote control cable and setting the CI-V, turn ON the exciter again.	pp. 2-5 ~ 2-7, 3-3
	"AUTO" is displayed under the frequency band button, but the exciter's operating frequency is not displayed or only displayed to 2 decimal places.	The information of the frequency counter is being acquired. Check the connections and settings for the CI-V.	pp. 2-4 ~ 3-3
It takes time to synchronize with the operating frequency and band of the Icom Exciter.	The Transceive function of the Icom exciter is turned OFF.	Turn ON the function.	p. 3-1
	The CI-V baud rate of the Icom exciter is set to "Auto."	Set the baud rate to "19200" or "9600."	p. 3-1
The operating frequency and band are not synchronized.	A non-Icom exciter is connected.	Operate an Icom exciter.	p. 2-4
The status of [INPUT 1] and [INPUT 2] cannot be changed from an external device.	The option of the "Exciter Connection" setting is different from the exciter connection pattern.	Set the appropriate option in the "Exciter Connection" setting.	p. 3-1
	There is a bad connection with [INPUT 1/2] jack.	<ul style="list-style-type: none"> Connect the cable to [INPUT 1/2]. Check the terminals of the cable. 	p. 1-2
	An inappropriate option is selected in the INPUT1/2 Selection Input setting.	Select an appropriate option.	p. 7-3
An external device connected to [REMOTE AUX] cannot be controlled.	There is a bad connection with [REMOTE AUX] jack.	Check the [REMOTE AUX] jack and the terminals of the cable.	p. 12-1
	An inappropriate option is selected in the REMOTE AUX CI-V Baud Rate setting.	Select an appropriate option.	p. 7-3
When changing the operating band, the antenna connector does not change to the one used in that band.	The antenna memory is not set.	Check the antenna memory setting.	p. 4-4
"Input signal to the INPUT 1/2 Connector is controlling." is displayed, and the switching operation cannot be performed.	An inappropriate option is selected in the INPUT1/2 Selection Input setting.	Reset to the default setting.	p. 7-3
	A signal is being input from an external device.	Stop the signal from the external device connected to [INPUT 1/2].	p. 12-1
Even if ANT is held down for 1 second, the antenna connector set in the [ANT] Switch (Hold down) setting is not selected.	The antenna connector is set "OFF" in the ANT1 ~ 6 Connector setting.	Select "ON."	p. 4-4
Even if ANT is pushed, the ANTENNA SELECT screen is not displayed.	"Select Antenna" is selected in the [ANT] Switch (Short Push) setting.	Select "Display ANTENNA SELECT screen."	p. 4-3
The maximum output power cannot be changed.	The linear amplifier is connected to a 90 ~ 132 V AC power source.	Connect to a 180 ~ 264 V AC power source.	p. 4-2
When adjusting the ALC level, no operation is performed, even if "AUTO" or "MANUAL" is touched.	An exciter is transmitting.	Stop transmitting from the exciter.	—
When transmitting with the linear amplifier circuit is turned ON, the antenna SWR becomes high.	The trap coil of the antenna is burnt out.	Connect an antenna that has a sufficient margin for the maximum input power.	p. 2-4
	Parasitic vibration (wraparound) has occurred.	If the antenna SWR becomes low with the linear amplifier circuit being turned OFF, check the cables and grounding.	—

Troubleshooting

Problem	Possible cause	Solution	REF.
Even if an exciter starts transmitting, the linear amplifier does not transmit or output power.	A coaxial cable is not connected, or there is a bad connection with the cable.	<ul style="list-style-type: none"> Connect the cable to an exciter. Check the cable. 	p. 2-4
	The accessory cable is not connected, or there is a bad connection with the cable.	<ul style="list-style-type: none"> Connect the cable to [ACC 1] or [ACC 2]. Check the terminals of the cable. 	pp. 2-5 ~ 2-7
	The RCA cable is not connected, or there is a bad connection with the cable.	<ul style="list-style-type: none"> Connect the cable to [SEND 1] or [SEND 2]. Check the cable. 	pp. 2-7, 2-8
	The RX side RF input connector (INPUT : Lights green) is selected.	Change the TX/RX side RF input connector (INPUT : Lights orange).	p. 4-2
	The ALC level is not adjusted.	Adjust the ALC level.	p. 3-3
	The protection circuit is activated.	Find and repair the cause of the problem, and then push PROTECT to deactivate the protection circuit.	p. 8-1
The output power is too low.	An exciter with a maximum transmit output power of less than 100 W is connected.	Connect an exciter with a maximum transmit output power of 100 W or 200 W.	p. 2-3
	The AC line voltage is low.	Remove the other equipment used in the same AC line as the linear amplifier.	—
	An exciter is transmitting at low transmit output power.	Transmit at maximum transmit output power.	—
	The ALC level is not adjusted.	Switch to the output power to be used and manually adjust the ALC level.	p. 3-3
	The antenna SWR is too high.	<ul style="list-style-type: none"> Adjust the SWR of the 50 Ω antenna used in the frequency band to transmit. Turn ON the internal antenna tuner. 	pp. 2-4, 4-1, 5-1
	The linear amplifier circuit is turned OFF.	Turn ON the linear amplifier circuit.	p. 4-1
The DPD function does not work.	An Icom exciter that does not support the function, or a non-Icom exciter is connected.	Connect an Icom exciter that supports the function.	—
	An Icom exciter is not adjusted to use the function.	Adjust the exciter to use the function.	—
The DPD adjustment is not possible.	The optional OPC-2501 COAXIAL CABLE FOR DPD FEEDBACK is not connected to [ALC 1] or [ALC 2].	<ul style="list-style-type: none"> Connect the cable to [ALC 1] or [ALC 2]. Check the terminals of the cable. 	p. 8-4
	The ALC level is not adjusted.	Adjust the ALC level.	p. 3-3
	A dummy load is not used.	After replacing an antenna with a dummy load, perform the DPD adjustment.	—
	The DPD adjustment for an Icom exciter alone is not completed.	After completing the DPD adjustment for an Icom exciter alone, perform the DPD linked adjustment with the amplifier.	—
	The antenna SWR is too high.	Check the cables used to connect to the exciter, and then adjust the antenna SWR to less than 1.5:1.	p. 2-4
Even if TUNER is held down for 1 second, an Icom exciter does not start transmitting for linked manual tuning.	The exciter firmware is not the latest version.	Update to the latest version that supports linked manual tuning.	p. 10-3

10 UPDATING THE FIRMWARE

General

◇ About updating the firmware

You can update the IC-PW2's firmware using an SD card. Updating the firmware adds new functions and/or improves performance parameters.

You can download the latest firmware from the Icom website.

<https://www.icomjapan.com/support/>

IMPORTANT: To update the firmware, first format your SD card using the IC-PW2. (p. 6-1)
Then copy the downloaded firmware data from your PC into the IC-PW2 folder on the card.

◇ Checking the firmware version

Check the firmware version when you turn ON the linear amplifier.

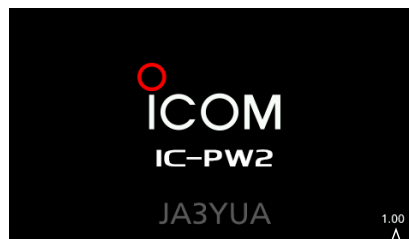

The firmware version is displayed

TIP: You can also check the firmware version on the VERSION screen.

MENU » SET > Others > Information > **Version**

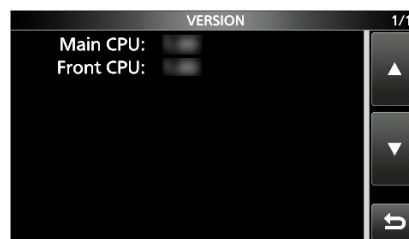

General

◇ Preparation

Access the following URL and download the firmware file.

<https://www.icomjapan.com/support/>

① These instructions are based on Microsoft Windows 10.

1. Click the “Firmware/Software” link.



2. Enter “IC-PW2” into the Search box, and then click [Search].

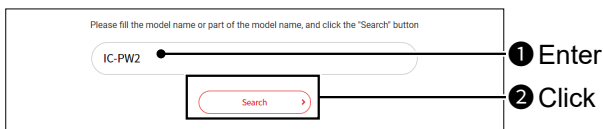

3. Click the desired firmware file link.

4. Carefully read “Regarding this Download Service.” Click “Agree,” and then click [Download].

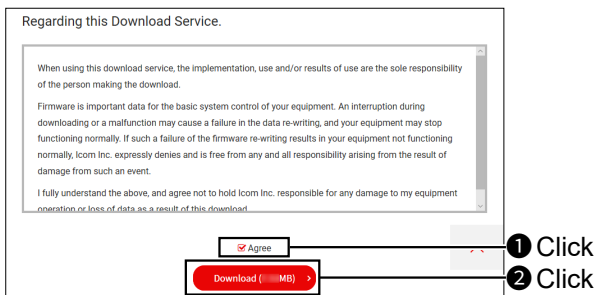

5. Click “Save as.”

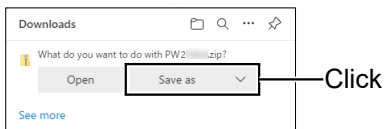

① The download procedure may differ, depending on your browser and its settings.

6. Select the location where you want to save the firmware, and then click [Save] in the displayed File Download dialog.
 - The file starts downloading.
 - The firmware and the firmware utility are compressed in a “zip” format folder. Unzip it before use.

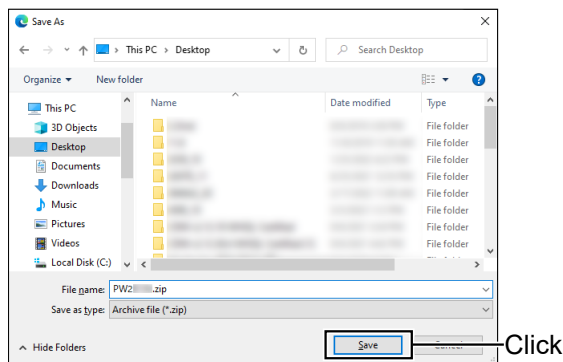

7. After completing the download, click the icon displayed when the mouse pointer is aligned.



- The folder with the downloaded file is opened.

◇ Unzipping the firmware folder

1. Right-click the downloaded firmware folder (zip format).
 - Right-click menu is displayed.
2. Click “Extract All...”

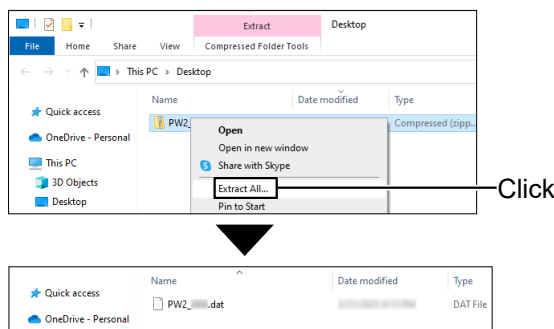

- After unzipping, a folder is created in the same location as the downloaded folder.
- ① In the “PW2*” folder, “PW2*.dat” is created.
 * Represents the release number.

Updating the firmware

CAUTION: NEVER turn OFF the linear amplifier while updating the firmware. If you turn OFF the amplifier, or if a power failure occurs while updating, the linear amplifier firmware will be damaged, and you will have to send the amplifier back to the nearest Icom distributor for repair. This type of repair is out of warranty, even if the linear amplifier warranty period is still valid.

TIP: BE SURE to unzip the downloaded file. See the previous page for details.

1. Copy the downloaded firmware data into the IC-PW2 folder onto an SD card.

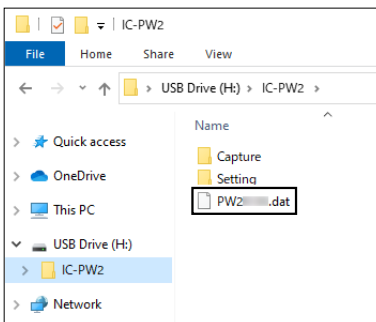

2. Insert the SD card into the linear amplifier. (p. 6-1)
3. Display the SD CARD screen.
MENU » **SET > SD Card**
4. Touch “Firmware Update.”

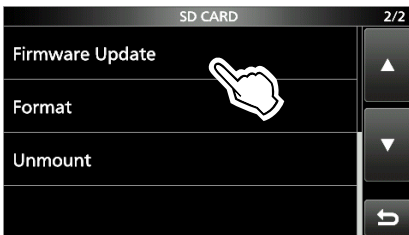

5. After you read and agree with all the precautions, touch [YES].
 - Scroll the screen and read all the precautions.
 - The confirmation dialog is displayed. When you touch [YES], the backup file is made on the SD card, and then the FIRMWARE UPDATE screen is displayed.

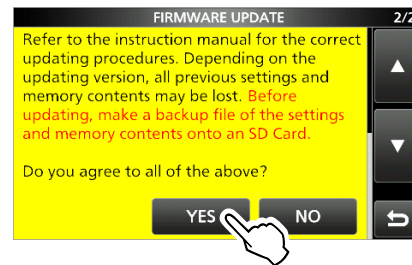
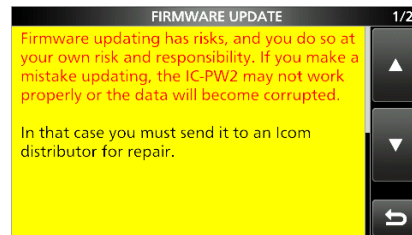

6. Touch the firmware (Example: PW2*).
* Represents the release number.

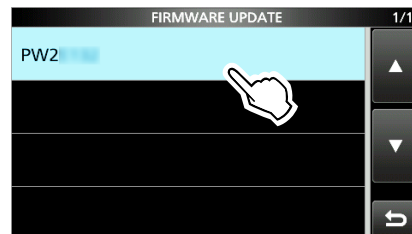

7. After you read and agree with all the precautions, touch [YES] for 1 second.
 - The final confirmation screen is displayed.
 - ① Carefully read all the displayed precautions.
 - The updating starts.

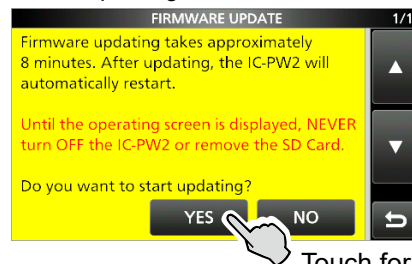

Touch for 1 second

8. When the update is completed, “Firmware updating has completed.” is displayed in the dialog.
 - The IC-PW2 will automatically restart.
 - ① After the update finishes, the Main screen is displayed.

Specifications

◇ General

- Frequency coverage:
 - 1.800000 ~ 1.999999 MHz
 - 3.500000 ~ 3.999999 MHz
 - 7.000000 ~ 7.300000 MHz
 - 10.100000 ~ 10.150000 MHz
 - 14.000000 ~ 14.350000 MHz
 - 18.068000 ~ 18.168000 MHz
 - 21.000000 ~ 21.450000 MHz
 - 24.890000 ~ 24.990000 MHz
 - 28.000000 ~ 29.700000 MHz
 - 50.000000 ~ 54.000000 MHz
- Usable temperature range:
 - 10°C ~ +40°C, 14°F ~ 104°F
- Input impedance:
 - 50 Ω (Unbalanced)
- Power supply requirement:
 - USA/EXP versions
 - 90 ~ 132 V AC (50 Hz/60 Hz),
 - 180 ~ 264 V AC (50 Hz/60 Hz)
 - EUR version
 - 180 ~ 264 V AC (50 Hz/60 Hz)
- Driving power:
 - Maximum 100 W
- Maximum output power:
 - 90 ~ 132 V AC: 500 W
 - 180 ~ 264 V AC: 1 kW/500 W
- Spurious emissions:
 - HF bands: Less than -60 dB
 - 50 MHz band: Less than -70 dB
 - ① This value does not apply to unwanted radiation (excluding harmonics) caused by an exciter.
- Dimensions (projections not included):
 - 425 (W) × 149 (H) × 445 (D) mm,
 - 16.7 (W) × 5.9 (H) × 17.5 (D) in
- Weight (approximate):
 - 21.6 kg, 47.6 lb

◇ Antenna tuner

- Matching impedance range:
 - 16.7 ~ 150.0 Ω
 - (HF band to 50 MHz band, and 5 MHz band)
 - ① Only tuning operation is guaranteed in the 5 MHz band.
- Antenna tuning accuracy:
 - VSWR 1.5:1 or less
- Automatic tuning time:
 - Approximately 2 to 3 seconds (general condition)
 - Maximum 15 seconds

① All stated specifications are subject to change without notice or obligation.

Options

Cables

- **OPC-2501** COAXIAL CABLE FOR DPD FEEDBACK
 - ① The cable has 3 m (9.8 ft).
- **OPK-5** OPTIONAL CABLE KIT
 - The following cables are included.
 - OPC-125B: Coaxial cable
 - Approximately 3 m, 9.8 feet
 - OPC-718: Remote control cable
 - Approximately 3 m, 9.8 feet
 - OPC-104B: Accessory cable
 - Approximately 3 m, 9.8 feet

12 CONNECTOR INFORMATION

[INPUT 1]/[INPUT 2]

Connects to an antenna connector of an exciter using a coaxial cable.

- Input/Output impedance: 50 Ω (unbalanced)

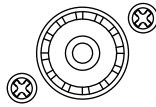

- ① Connect an exciter with a maximum transmit output power of 100 or 200 W.
- ② After connecting an exciter, select an appropriate option in the following setting.

MENU » **EXCITER > Exciter Connection**

[RX-ANT IN]/[RX-ANT OUT]

Connects to an external unit, such as a preamplifier, a band-pass filter, or an attenuator, inserted directly below each antenna (ANT 1 ~ ANT 6).

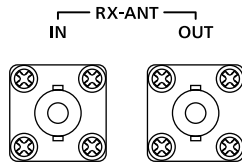

- Input impedance: 50 Ω (unbalanced)
- Connector type: BNC

- ① The ON/OFF setting of RX-I/O can be changed in the ANTENNA SELECT screen of **INPUT** (Lights green: RX side). (p. 4-5)
- ② When the RX-I/O setting is enabled, a signal received from ANT 1 ~ ANT 6 is output to [RX-ANT OUT]. A signal passed through an external device (example: band-pass filter), connected as shown below, is input to [RX-ANT IN].

RX-I/O circuit schematic diagram:

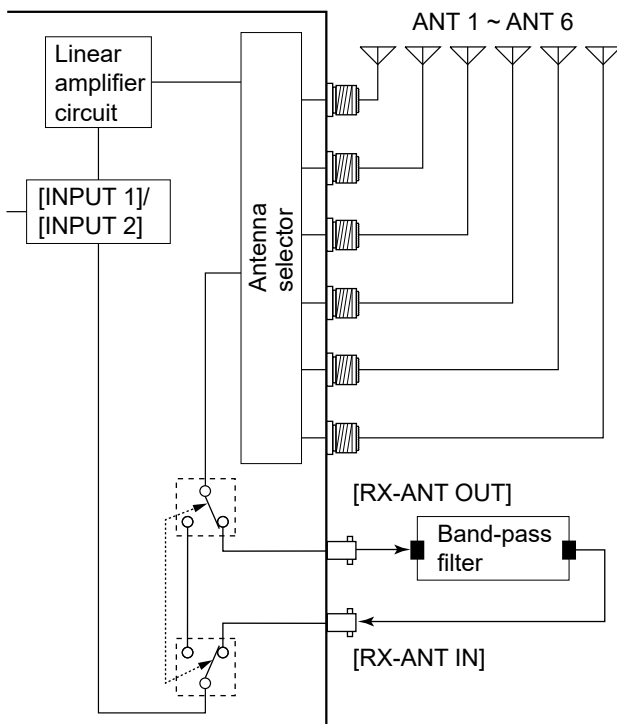

[INPUT 1/2]

Connects to an external device to control the operations of [INPUT 1] and [INPUT 2].

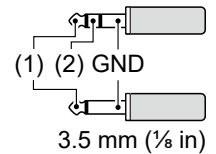

- ① The switching operation between [INPUT 1] and [INPUT 2] according to the signal (Low or Open) input from the external device can be changed in the following setting.

MENU » **SET > Connectors > INPUT1/2 Selection Input**

- ① When the option to set (2) to unconnected is selected in the INPUT1/2 Selection Input setting, the stereo mini plug operates as a monaural mini plug.

[LAN]

This terminal is used for time synchronization by an NTP server.

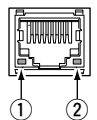

About the LED indication

- ① LINK/ACT
 - Lights green when a cable is connected.
 - Does not light when a cable is not connected.
 - Blinks green while communicating.
- ② Speed
 - Lights green while communicating in 100BASE-TX.
 - Does not light while communicating in 10BASE-T or is not connected.

[REMOTE AUX]

Connects to control the linear amplifier (Turning the power ON or OFF, and so on) or an external device, such as an antenna rotator controller or a band decoder, using CI-V commands.

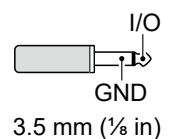

- ① When sending information, such as the frequency band of the amplifier, to an external device, the CI-V settings may be required.

MENU » **SET > Connectors > CI-V**

[ANT 1] to [ANT 6]

Connects a 50 Ω antenna for the HF band and the 50 MHz band, or a dummy load.

- Input/Output impedance: 50 Ω (unbalanced)
- ① Use an antenna or dummy load with a sufficient margin for the maximum input power.
 - ② You can set whether or not to use each antenna connector and specify the connector for each frequency band in the following setting.



MENU » **ANT**

[ACC 1]/[ACC 2]

Connects to an Icom exciter to input and output control signals for the linear amplifier.

① [ACC 1] corresponds to the exciter connected to [INPUT 1]. [ACC 2] corresponds to the exciter connected to [INPUT 2].

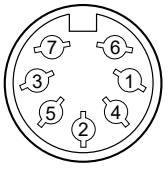
ACC 1/ACC 2	PIN No.	NAME	DESCRIPTION	SPECIFICATIONS
 <p>7-pin Rear panel view</p>	1	NC	No connection.	–
	2	GND	Connects to ground.	–
	3	SEND	A terminal that puts the linear amplifier into the transmission state, synchronized with the transmission of an Icom exciter.	Output voltage (TX): –0.5 V to +0.8 V Output current: Less than 20 mA
	4	NC	No connection.	–
	5	ALC	ALC voltage output.	Control voltage: –10 to 0 V
	6	NC	No connection.	–
	7	13.8 V	13.8 V DC input terminal.	Input current: Less than 1 A

[REMOTE 1]/[REMOTE 2]

Connects to an Icom exciter to remotely control the linear amplifier using CI-V commands.

① [REMOTE 1] corresponds to the exciter connected to [INPUT 1].

[REMOTE 2] corresponds to the exciter connected to [INPUT 2].

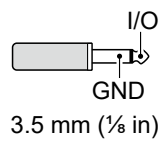

NOTE: BE SURE to connect one-to-one with an Icom exciter.

The amplifier does not support remote control of multiple units using a CI-V level converter.

[SEND 1]/[SEND 2]

Connects to a non-Icom exciter to synchronize transmission and reception.

① See pages 2-7 and 2-8 for connecting with a non-Icom exciter.

① When this connector goes to ground, the amplifier transmits.

① [SEND 1] corresponds to the exciter connected to [INPUT 1].
[SEND 2] corresponds to the exciter connected to [INPUT 2].

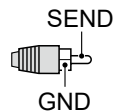
**[ALC 1]/[ALC 2]**

- Connect to output the ALC voltage to a non-Icom exciter.
- When an Icom exciter is connected, and the Digital Pre-Distortion (DPD) function is used, outputs the feedback signal.

① [ALC 1] corresponds to the exciter connected to [INPUT 1].
[ALC 2] corresponds to the exciter connected to [INPUT 2].

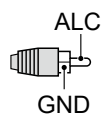
**[BAND 1]/[BAND 2]**

This terminal is used to control an external device connected to [RX-ANT IN] and [RX-ANT OUT], depending on the voltage of the selected frequency band.

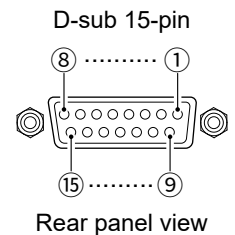

PIN No.	OUTPUT BAND
①	1.8 MHz
②	3.5 MHz
③	7 MHz
④	14 MHz
⑤	21 MHz
⑥	28 MHz
⑦	GND
⑧	NC

PIN No.	OUTPUT BAND
⑨	NC
⑩	NC
⑪	10 MHz
⑫	18 MHz
⑬	24 MHz
⑭	50 MHz
⑮	NC

① [BAND 1] corresponds to the exciter connected to [INPUT 1].
[BAND 2] corresponds to the exciter connected to [INPUT 2].

① The band voltage is output even if the RF input connector ([INPUT 1]/[INPUT 2]) is set to **INPUT** (Gray: OFF).

① The band voltage output condition can be changed in the following settings.

MENU » SET > Connectors > Selected BAND
Output > **Output Type (BAND1)**

MENU » SET > Connectors > Selected BAND
Output > **Output Type (BAND2)**

ABOUT THE LICENSES

Information on the open source software being used by this product.

COPYRIGHT NOTICE, DISCLAIMER, and LICENSE:

If you modify libpng you may insert additional notices immediately following this sentence.

This code is released under the libpng license.

libpng versions 1.2.6, August 15, 2004, through 1.6.12, June 12, 2014, are Copyright (c) 2004, 2006-2014 Glenn Randers-Pehrson, and are distributed according to the same disclaimer and license as libpng-1.2.5 with the following individual added to the list of Contributing Authors:

Cosmin Truta

libpng versions 1.0.7, July 1, 2000, through 1.2.5, October 3, 2002, are Copyright (c) 2000-2002 Glenn Randers-Pehrson, and are distributed according to the same disclaimer and license as libpng-1.0.6 with the following individuals added to the list of Contributing Authors:

Simon-Pierre Cadieux
Eric S. Raymond
Gilles Vollant

and with the following additions to the disclaimer:

There is no warranty against interference with your enjoyment of the library or against infringement. There is no warranty that our efforts or the library will fulfill any of your particular purposes or needs. This library is provided with all faults, and the entire risk of satisfactory quality, performance, accuracy, and effort is with the user.

libpng versions 0.97, January 1998, through 1.0.6, March 20, 2000, are Copyright (c) 1998, 1999, 2000 Glenn Randers-Pehrson, and are distributed according to the same disclaimer and license as libpng-0.96, with the following individuals added to the list of Contributing Authors:

Tom Lane
Glenn Randers-Pehrson
Willem van Schaik

libpng versions 0.89, June 1996, through 0.96, May 1997, are Copyright (c) 1996, 1997 Andreas Dilger Distributed according to the same disclaimer and license as libpng-0.88, with the following individuals added to the list of Contributing Authors:

John Bowler
Kevin Bracey
Sam Bushell
Magnus Holmgren
Greg Roelofs
Tom Tanner

libpng versions 0.5, May 1995, through 0.88, January 1996, are Copyright (c) 1995, 1996 Guy Eric Schalnat, Group 42, Inc.

For the purposes of this copyright and license, "Contributing Authors" is defined as the following set of individuals:

Andreas Dilger
Dave Martindale
Guy Eric Schalnat
Paul Schmidt
Tim Wegner

The PNG Reference Library is supplied "AS IS". The Contributing Authors and Group 42, Inc. disclaim all warranties, expressed or implied, including, without limitation, the warranties of merchantability and of fitness for any

purpose. The Contributing Authors and Group 42, Inc. assume no liability for direct, indirect, incidental, special, exemplary, or consequential damages, which may result from the use of the PNG Reference Library, even if advised of the possibility of such damage.

Permission is hereby granted to use, copy, modify, and distribute this source code, or portions hereof, for any purpose, without fee, subject to the following restrictions:

1. The origin of this source code must not be misrepresented.
2. Altered versions must be plainly marked as such and must not be misrepresented as being the original source.
3. This Copyright notice may not be removed or altered from any source or altered source distribution.

The Contributing Authors and Group 42, Inc. specifically permit, without fee, and encourage the use of this source code as a component to supporting the PNG file format in commercial products. If you use this source code in a product, acknowledgment is not required but would be appreciated.

A "png_get_copyright" function is available, for convenient use in "about" boxes and the like:

```
printf("%s", png_get_copyright(NULL));
```

Also, the PNG logo (in PNG format, of course) is supplied in the files "pngbar.png" and "pngbar.jpg (88x31)" and "pngnow.png" (98x31).

Libpng is OSI Certified Open Source Software. OSI Certified is a certification mark of the Open Source Initiative.

The contributing authors would like to thank all those who helped with testing, bug fixes, and patience. This wouldn't have been possible without all of you.

Thanks to Frank J. T. Wojcik for helping with the documentation.

License for CMSIS-RTOS RTX Implementation

Copyright (c) 1999-2009 KEIL, 2009-2013 ARM Germany GmbH All rights reserved.

Redistribution and use in source and binary forms, with or without modification, are permitted provided that the following conditions are met:

- Redistributions of source code must retain the above copyright notice, this list of conditions and the following disclaimer.

- Redistributions in binary form must reproduce the above copyright notice, this list of conditions and the following disclaimer in the documentation and/or other materials provided with the distribution.

- Neither the name of ARM nor the names of its contributors may be used to endorse or promote products derived from this software without specific prior written permission.

THIS SOFTWARE IS PROVIDED BY THE COPYRIGHT HOLDERS AND CONTRIBUTORS "AS IS" AND ANY EXPRESS OR IMPLIED WARRANTIES, INCLUDING, BUT NOT LIMITED TO, THE IMPLIED WARRANTIES OF MERCHANTABILITY AND FITNESS FOR A PARTICULAR PURPOSE ARE DISCLAIMED. IN NO EVENT

SHALL COPYRIGHT HOLDERS AND CONTRIBUTORS BE LIABLE FOR ANY DIRECT, INDIRECT, INCIDENTAL, SPECIAL, EXEMPLARY, OR CONSEQUENTIAL DAMAGES (INCLUDING, BUT NOT LIMITED TO, PROCUREMENT OF SUBSTITUTE GOODS OR SERVICES; LOSS OF USE, DATA, OR PROFITS; OR BUSINESS INTERRUPTION) HOWEVER CAUSED AND ON ANY THEORY OF LIABILITY, WHETHER IN CONTRACT, STRICT LIABILITY, OR TORT (INCLUDING NEGLIGENCE OR OTHERWISE) ARISING IN ANY WAY OUT OF THE USE OF THIS SOFTWARE, EVEN IF ADVISED OF THE POSSIBILITY OF SUCH DAMAGE.

ZLIB DATA COMPRESSION LIBRARY

zlib 1.2.8 is a general purpose data compression library. All the code is thread safe. The data format used by the zlib library is described by RFCs (Request for Comments) 1950 to 1952 in the files <http://tools.ietf.org/html/rfc1950> (zlib format), [rfc1951](http://tools.ietf.org/html/rfc1951) (deflate format) and [rfc1952](http://tools.ietf.org/html/rfc1952) (gzip format).

All functions of the compression library are documented in the file `zlib.h` (volunteer to write man pages welcome, contact zlib@gzip.org). A usage example of the library is given in the file `test/example.c` which also tests that the library is working correctly. Another example is given in the file `test/minigzip.c`. The compression library itself is composed of all source files in the root directory.

To compile all files and run the test program, follow the instructions given at the top of `Makefile.in`. In short `./configure; make test`, and if that goes well, `"make install"` should work for most flavors of Unix. For Windows, use one of the special makefiles in `win32/` or `contrib/vstudio/`. For VMS, use `make_vms.com`.

Questions about zlib should be sent to zlib@gzip.org, or to Gilles Vollant info@winimage.com for the Windows DLL version. The zlib home page is <http://zlib.net/>. Before reporting a problem, please check this site to verify that you have the latest version of zlib; otherwise get the latest version and check whether the problem still exists or not.

PLEASE read the zlib FAQ http://zlib.net/zlib_faq.html before asking for help.

Mark Nelson markn@ieee.org wrote an article about zlib for the Jan. 1997 issue of Dr. Dobbs's Journal; a copy of the article is available at <http://marknelson.us/1997/01/01/zlib-engine/>.

The changes made in version 1.2.8 are documented in the file `ChangeLog`.

Unsupported third party contributions are provided in directory `contrib/`.

zlib is available in Java using the `java.util.zip` package, documented at <http://java.sun.com/developer/technicalArticles/Programming/compression/>.

A Perl interface to zlib written by Paul Marquess pmqs@cpan.org is available at CPAN (Comprehensive Perl Archive Network) sites, including <http://search.cpan.org/~pmqs/IO-Compress-Zlib/>.

A Python interface to zlib written by A.M. Kuchling amk@amk.ca is available in Python 1.5 and later versions, see <http://docs.python.org/library/zlib.html>.

zlib is built into tcl: <http://wiki.tcl.tk/4610>.

An experimental package to read and write files in .zip format, written on top of zlib by Gilles Vollant info@winimage.com, is available in the `contrib/minizip` directory of zlib.

Notes for some targets:

- For Windows DLL versions, please see `win32/DLL_FAQ.txt`

- For 64-bit Irix, `deflate.c` must be compiled without any optimization. With `-O`, one libpng test fails. The test works in 32 bit mode (with the `-n32` compiler flag). The compiler bug has been reported to SGI.

- zlib doesn't work with gcc 2.6.3 on a DEC 3000/300LX under OSF/1 2.1 it works when compiled with cc.

- On Digital Unix 4.0D (formerly OSF/1) on AlphaServer, the `cc` option `-std1` is necessary to get `gzprintf` working correctly. This is done by configure.

- zlib doesn't work on HP-UX 9.05 with some versions of `/bin/cc`. It works with other compilers. Use "make test" to check your compiler.

- `gzdopen` is not supported on RISCOS or BEOS.

- For PalmOs, see <http://palmzlib.sourceforge.net/>

Acknowledgments:

The deflate format used by zlib was defined by Phil Katz. The deflate and zlib specifications were written by L. Peter Deutsch. Thanks to all the people who reported problems and suggested various improvements in zlib; they are too numerous to cite here.

Copyright notice:

(C) 1995-2013 Jean-loup Gailly and Mark Adler

This software is provided 'as-is', without any express or implied warranty. In no event will the authors be held liable for any damages arising from the use of this software.

Permission is granted to anyone to use this software for any purpose, including commercial applications, and to alter it and redistribute it freely, subject to the following restrictions:

1. The origin of this software must not be misrepresented; you must not claim that you wrote the original software. If you use this software in a product, an acknowledgment in the product documentation would be appreciated but is not required.

2. Altered source versions must be plainly marked as such, and must not be misrepresented as being the original software.

3. This notice may not be removed or altered from any source distribution.

Jean-loup Gailly Mark Adler jloup@gzip.org
madler@alumni.caltech.edu

If you use the zlib library in a product, we would appreciate "not" receiving lengthy legal documents to sign. The sources are provided for free but without warranty of any kind. The library has been entirely written by Jean-loup Gailly and Mark Adler; it does not include third-party code.

If you redistribute modified sources, we would appreciate that you include in the file `ChangeLog` history information documenting your changes. Please read the FAQ for more information on the distribution of modified source versions.

A series of horizontal dotted lines for writing, spanning the width of the page.

