



BASIC MANUAL

COMMUNICATIONS RECEIVER IC-R15

This device complies with part 15 of the FCC Rules. Operation is subject to the condition that this device does not cause harmful interference.

WARNING: MODIFICATION OF THIS DEVICE TO RECEIVE CELLULAR RADIOTELEPHONE SERVICE SIGNALS IS PROHIBITED UNDER FCC RULES AND FEDERAL LAW.



Icom Inc.

Thank you for choosing this Icom product. This product was designed and built with Icom's state of the art technology and craftsmanship. With proper care, this product should provide you with years of trouble-free operation.

■ Important

READ ALL INSTRUCTIONS carefully and completely before using the receiver.
SAVE THIS INSTRUCTION MANUAL — This instruction manual contains basic operating instructions for the IC-R15.

For advanced operating instructions, see the Advanced manual for details.

The Advanced manual can be downloaded from the following internet address:
<https://www.icomjapan.com/support/>

■ Features

- Dualwatch function that can simultaneously receive and record two different bands or modes.
- A USB connector for data transmission or battery charging
- A microSD card slot that can accept different cards to backup settings, various memories, and so on.
- Bluetooth® function that can connect to a Bluetooth® device
- Meets IPX7 requirements for waterproof protection
(When the battery, the antenna, the [↻] jack cover, [USB] cover, and the [microSD] slot cover are attached)

■ Explicit definitions

WORD	DEFINITION
⚠ DANGER!	Personal death, serious injury or an explosion may occur.
⚠ WARNING!	Personal injury, fire hazard or electric shock may occur.
CAUTION	Equipment damage may occur.
NOTE	Recommended for optimum use. No risk of personal injury, fire or electric shock.

Icom is not responsible for the destruction, damage to, or performance of any Icom or non-Icom equipment, if the malfunction is because of:

- Force majeure, including, but not limited to, fires, earthquakes, storms, floods, lightning, other natural disasters, disturbances, riots, war, or radioactive contamination.
- The use of Icom receivers with any equipment that is not manufactured or approved by Icom.

About weld lines

This product's surfaces may have streaks called "weld lines," that occur during the molding process, and are not cracks or flaws.

■ Precautions

⚠ **DANGER! NEVER** operate the receiver near unshielded electrical blasting caps or in an explosive atmosphere. This could cause an explosion and death.

⚠ **WARNING! NEVER** use or charge Icom battery packs with non-Icom receivers or non-Icom chargers. Only Icom battery packs are tested and approved for use with Icom receivers or charged with Icom chargers. Using third-party or counterfeit battery packs or chargers may cause smoke, fire, or cause the battery to burst.

⚠ **WARNING! NEVER** operate the equipment with earphones, a earphone, or other audio accessories at high volume levels. The continuous high volume operation may cause a ringing in your ears. If you experience the ringing in your ears, reduce a volume level or discontinue use.

CAUTION: DO NOT operate the receiver while driving a vehicle. Safe driving requires your full attention— anything less could result in an accident.

CAUTION: DO NOT short the terminals of the battery pack. Shorting may occur if the terminals touch metal objects such as a key, so be careful when placing the battery packs (or the receiver) in bags, and so on. Carry them so that shorting cannot occur with metal objects. Shorting may damage not only the battery pack, but also the receiver.

CAUTION: DO NOT connect the receiver directly to a power source of more than the specified DC voltage or use reverse polarity. Otherwise this will damage the receiver.

CAUTION: DO NOT operate the receiver unless the antenna, battery pack and covers are securely attached to the receiver and that the antenna and battery pack are dry before attachment. Exposing the inside to dust or water can damage the receiver. After exposure to water, clean the battery contacts thoroughly with fresh water and dry them completely to remove any water or salt residue.

CAUTION: DO NOT use harsh solvents such as Benzine or alcohol when cleaning. This could damage the equipment surfaces. If the surface becomes dusty or dirty, wipe it clean with a soft, dry cloth.

CAUTION: DO NOT place or leave the receiver in direct sunlight or in areas with temperatures below -20°C (-4°F) or above $+60^{\circ}\text{C}$ ($+140^{\circ}\text{F}$).

CAUTION: DO NOT change the internal settings of the equipment. This may reduce equipment performance and/or cause extensive and expensive damage to the equipment. The equipment warranty does not cover any problems caused by unauthorized internal adjustments.

NEVER place in an insecure place to avoid inadvertent use by unauthorized persons.

BE CAREFUL! The receiver meets IPX7* requirements for waterproof protection. However, once the receiver has been dropped, or the waterproof seal is cracked or damaged, the waterproof protection cannot be guaranteed.

* Only when the BP-287, the antenna, [⌚] jack cover, [USB] cover, and [microSD] slot cover are attached.

Even when the receiver power is OFF, a slight current still flows in the circuits. Remove the battery pack or batteries from the receiver when not using it for a long time. Otherwise, the installed battery pack or batteries will become exhausted, and will need to be recharged or replaced.

The LCD display may have cosmetic imperfections that appear as small dark or light spots. This is not a malfunction or defect, but a normal characteristic of LCD displays.

■ Battery cautions

Misuse of Li-ion batteries may result in the following hazards: smoke, fire, or the battery may rupture. Misuse can also cause damage to the battery or degradation of battery's performance.

⚠ **DANGER! NEVER** incinerate used battery packs. Internal battery gas may cause an explosion.

⚠ **DANGER! NEVER** strike or otherwise impact the battery pack. Do not use the battery pack if it has been severely impacted or dropped, or if the pack has been subjected to heavy pressure. Battery pack damage may not be visible on the outside of the case. Even if the surface of the battery does not show cracks or any other damage, the cells inside the battery may rupture or catch fire.

⚠ **DANGER! NEVER** leave the battery pack in places with temperatures above 60°C (140°F). High temperature buildup in the battery cells, such as could occur near fires or stoves, inside a sun-heated vehicle, or in direct sunlight for long periods of time, may cause the battery cells to rupture or catch fire. Excessive temperatures may also degrade the pack's performance or shorten the battery cell's life.

⚠ **DANGER! NEVER** place battery packs near a fire. Fire or heat may cause them to rupture or explode. Dispose of used battery packs in accordance with local regulations.

⚠ **DANGER! NEVER** solder the battery terminals, or **NEVER** modify the battery pack. This may cause heat generation, and the battery may burst, emit smoke or catch fire.

⚠ **DANGER! NEVER** let fluid from inside the battery get in your eyes. This can cause blindness. Rinse your eyes with clean water, without rubbing them, and immediately go to a doctor.

⚠ **WARNING! NEVER** use deteriorated battery packs. They could cause a fire.

⚠ **WARNING! NEVER** let fluid from inside the battery cells come in contact with your body. If it does, immediately wash with clean water.

⚠ **WARNING! NEVER** put the battery pack in a microwave oven, high-pressure container, or in an induction heating cooker. This could cause a fire, overheating, or cause the battery cells to rupture.

CAUTION: DO NOT expose the battery pack to rain, snow, saltwater, or any other liquids. Do not charge or use a wet pack. If the pack gets wet, be sure to wipe it dry cloth before using.

CAUTION: DO NOT continue to use the battery pack if it emits an abnormal odor, heats up, or is discolored or deformed. If any of these conditions occur, contact your Icom dealer or distributor.

CAUTION: DO NOT use the battery pack out of the specified temperature range -20°C ~ +60°C (-4°F ~ +140°F). Using the battery out of this range will reduce its performance and battery cell's life.

CAUTION: DO NOT leave the pack fully charged, completely discharged, or in an excessive temperature environment (above 50°C, 122°F) for an extended period of time. Otherwise, a shorter battery pack life could occur. If the battery pack must be left unused for a long time, it must be detached from the receiver after discharging. You may use the pack until the remaining capacity is about half, then keep it safely in a cool, dry place in the following temperature range:

-20°C (-4°F) ~ +50°C (+122°F) (within a month).
-20°C (-4°F) ~ +40°C (+104°F) (within three months).
-20°C (-4°F) ~ +20°C (+68°F) (within a year).

BE SURE to replace the battery pack with a new one approximately five years after manufacturing, even if it still holds a charge. The material inside the battery cells will become weak after a period of time, even with little use. The estimated number of times you can charge the pack is between 300 and 500. Even when the pack appears to be fully charged, the operating time of the receiver may become short when:

- Approximately 5 years have passed since the pack was manufactured.
- The pack has been repeatedly charged.

The battery cells may deteriorate and swell due to their characteristics if used in an environment and conditions such as: frequently charged, recharged immediately after full charge, used or saved in a hot place, or charged by methods other than the instructions. If the battery pack swells, it has reached the end of its life due to deterioration. Replace it with a brand new one.

■ Charging cautions

⚠ **DANGER! NEVER** charge the battery pack in areas with extremely high temperatures, such as near fires or stoves, inside a sun-heated vehicle, or in direct sunlight. In such environments, the safety/protection circuit in the pack will activate and stop the charging.

⚠ **WARNING! NEVER** charge the receiver during a lightning storm. It may result in an electric shock, cause a fire, or damage the receiver. Always disconnect the power adapter before a storm.

⚠ **WARNING! NEVER** charge or leave the battery in the battery charger beyond the specified time for charging. If the pack is not completely charged by the specified time, stop charging and remove it from the battery charger. Continuing to charge the pack beyond the specified time limit may cause a fire, overheating, or the battery may rupture.

⚠ **WARNING!** Occasionally observe the battery pack condition while charging. If any abnormal condition occurs, discontinue using the battery pack.

CAUTION: DO NOT insert the receiver (battery attached to the receiver) into the charger if it is wet or soiled. This could corrode the battery charger terminals or damage the charger. The charger is not waterproof.

CAUTION: DO NOT charge the battery pack outside of the specified temperature range: 15°C ~ 40°C (59°F ~ 104°F). Icom recommends charging the pack at 25°C (77°F). The pack may heat up or rupture if charged out of the specified temperature range. Additionally, battery performance or battery life may be reduced.

■ FCC Information

This equipment has been tested and found to comply with the limits for a Class B digital device, pursuant to part 15 of the FCC Rules. These limits are designed to provide reasonable protection against harmful interference in a residential installation. This equipment generates, uses, and can radiate radio frequency energy and, if not installed and used in accordance with the instructions, may cause harmful interference to radio communications. However, there is no guarantee that interference will not occur in a particular installation. If this equipment does cause harmful interference to radio or television reception, which can be determined by turning the equipment off and on, the user is encouraged to try to correct the interference by one or more of the following measures:

- Reorient or relocate the receiving antenna.
- Increase the separation between the equipment and receiver.
- Connect the equipment into an outlet on a circuit different from that to which the receiver is connected.
- Consult the dealer or an experienced radio/TV technician for help.

CAUTION: Changes or modifications to this device, not expressly approved by Icom Inc., could void your authority to operate this device under FCC regulations.

Internal Bluetooth unit information:

FCC ID: 2AMWOFSC-BT1036C
IC: 23872-FSCBT1036C

For Canada:

This device contains licence-exempt receiver(s) that comply with Innovation, Science and Economic Development Canada (ISED)'s licence-exempt RSS(s). Operation is subject to the following two conditions: (1) this device may not cause interference, and (2) this device must accept any interference, including interference that may cause undesired operation of the device.

■ Disposal



The crossed-out wheeled-bin symbol on your product, literature, or packaging reminds you that in the European Union, all electrical and electronic products, batteries, and accumulators (rechargeable batteries) must be taken to designated collection locations at the end of their working life. Do not dispose of these products as unsorted municipal waste. Dispose of them according to the laws in your area.

■ About CE and DOC

CE Hereby, Icom Inc. declares that the versions of IC-R15 which have the "CE" symbol on the product, comply with the essential requirements of the Radio Equipment Directive, 2014/53/EU, and the restriction of the use of certain hazardous substances in electrical and electronic equipment Directive, 2011/65/EU. The full text of the EU declaration of conformity is available at the following internet address:
<https://www.icomjapan.com/support/>

■ About UKCA DOC

To obtain the UKCA Declaration of Conformity, please contact Icom UK Limited by email at info@icomuk.co.uk or alternatively call + 44(0) 1227 741741.

■ Recommendation

CLEAN THE RECEIVER THOROUGHLY IN A BOWL OF FRESH WATER after exposure to saltwater, and dry it before operating. Otherwise, the receiver's keys and switches may become unusable, due to salt crystallization, and/or the charging terminals of the battery pack may corrode.

NOTE: If the receiver's waterproof protection appears defective, carefully clean it with a soft, damp (fresh water) cloth, then dry it before operating. The receiver may lose its waterproof protection if the case, jack cap, or connector cover is cracked or broken, or the receiver has been dropped. Contact your Icom distributor or your dealer for advice.

■ Trademarks

Icom and the Icom logo are registered trademarks of Icom Incorporated (Japan) in Japan, the United States, the United Kingdom, Germany, France, Spain, Russia, Australia, New Zealand, and/or other countries.

Adobe, Acrobat, and Reader are either registered trademarks or trademarks of Adobe Systems Incorporated in the United States and/or other countries.

The Bluetooth word mark and logos are registered trademarks owned by the Bluetooth SIG, Inc. and any use of such marks by Icom Inc. is under license. Other trademarks and trade names are those of their respective owners.

All other products or brands are registered trademarks or trademarks of their respective holders.

This product includes "mbed TLS" open source software, and is licensed according to the open source software license.

Refer to the "About the Licenses" page at the end of the manual in English for information on the open source software being used in this product.

■ Operating theory

Electromagnetic radiation, which has frequencies of 20,000 Hz (20 kHz*) and above, is called radio frequency (RF) energy because, it is useful in radio transmissions. The IC-R15 receives RF energy from 76.000 MHz* to 500.000 MHz for the European version, or from 88.000 MHz* to 500.000 MHz for the USA version and converts it into audio frequency (AF) energy which in turn actuates a loudspeaker to create sound waves. AF energy is in the range of 20 to 20,000 Hz. * kHz is an abbreviation of kilohertz or 1,000 hertz, MHz is abbreviation of megahertz or 1,000,000 hertz, where hertz is a unit of frequency.

■ Operating notes

The IC-R15 may receive its own oscillated frequency, resulting in no reception or only noise reception, on some frequencies. The IC-R15 may receive interference from extremely strong signals on different frequencies or when using an external high-gain antenna.

■ Supplied accessories

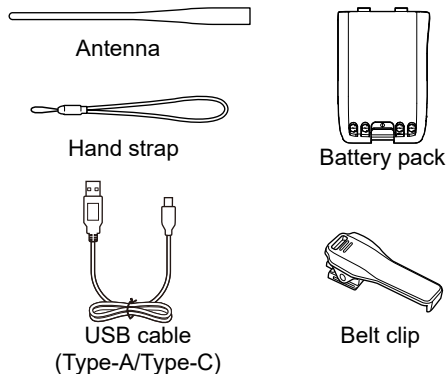

NOTE: Some accessories are not supplied, or the shape is different, depending on the receiver version.

■ Important notes

◇ Spurious signals

You may hear some noises caused by spurious signals generated in the receiver's circuit but they do not indicate a receiver malfunction.

◇ Noise signals while charging

You may hear some noises caused by signals generated in the charging circuit. Be sure to turn OFF the receiver before charging.

◇ Scanning in the Dualwatch operation

The Dualwatch function simultaneously monitors 2 frequencies. For example, if you are receiving in the AM mode on one band and scanning on the other band, you may hear noise due to voltage fluctuations when switching frequencies because the 2 receiving circuits share the antenna on the IC-R15. However, this is not a receiver malfunction.

◇ Time Setting

IC-R15 does not have the function to automatically set the time. We recommend you set the time from the SET mode before operating.

([MENU] > SET > Time Set > **Date/Time**)

- ① Set the time even if the battery pack has been removed for more than a day.
- ① CS-R15 PROGRAMMING SOFTWARE (purchase separately) can automatically set the time.

■ About the IC-R15 manuals

You can use the following manuals to understand and operate this receiver.

(As of February 2024)

TIP:

You can download each manual and guide from the Icom website:
<https://www.icomjapan.com/support/>
Enter "IC-R15" into the Search box on the site.

To read the manuals or Guide, Adobe® Acrobat® Reader® is required. If you have not installed it, download and install Adobe® Acrobat® Reader® from Adobe Systems Incorporated's website.

Basic manual (This manual)

Instructions for the basic operations, precautions and specifications.

Advanced manual (PDF type)

Instructions for the advanced operations, as shown below.

- Battery operation
- Using a microSD card
- Memory operation
- FM Radio operation
- Scan operation
- Recording the received audio
- Set mode
- Other functions
- Firmware updating
- Options

CI-V Reference Guide (PDF type)

Describes the control commands used in remote control operation (serial communication using CI-V).

■ Table of contents

■ Important.....	i	3 BASIC OPERATION.....	10
■ Features.....	i	■ MENU screen.....	10
■ Explicit definitions.....	i	◇ MENU screen operation.....	10
■ Precautions.....	ii	◇ Selecting a Menu item.....	11
■ Battery cautions.....	iii	■ Quick Menu window.....	12
■ Charging cautions.....	iv	■ Dualwatch operation.....	13
■ FCC Information.....	v	◇ Turning Dualwatch ON or OFF....	13
■ Disposal.....	v	◇ MAIN band selection.....	13
■ About CE and DOC.....	v	■ Setting a squelch level.....	14
■ About UKCA DOC.....	v	■ Monitor function.....	14
■ Recommendation.....	vi	■ Receiving.....	15
■ Trademarks.....	vi	◇ Selecting the Frequency Selecting	15
■ Operating theory.....	vi	mode.....	15
■ Operating notes.....	vi	◇ Selecting the receive mode.....	15
■ Supplied accessories.....	vi	◇ Selecting the receive band.....	16
■ Important notes.....	vii	■ Setting a frequency.....	16
◇ Spurious signals.....	vii	◇ Selecting the 1 MHz tuning.....	16
◇ Noise signals while charging.....	vii	◇ Selecting a tuning step.....	16
◇ Scanning in the Dualwatch	vii	■ Attenuator.....	17
operation.....	vii	■ Lock function.....	17
◇ Time Setting.....	vii	■ AF Filter function.....	17
■ About the IC-R15 manuals.....	vii	4 MEMORY OPERATION.....	18
1 PREPARATION.....	1	■ Selecting a Memory channel.....	18
■ Attaching the supplied accessories ..	1	■ Viewing the Memory channel	18
◇ Battery pack.....	1	contents.....	18
◇ Antenna.....	1	◇ About the Memory channel	19
◇ Hand strap.....	1	contents.....	19
◇ Belt clip.....	1	■ Entering Memory channels.....	20
■ Charging the battery pack.....	2	5 SCANNING.....	21
◇ Capacity of the battery pack.....	2	■ Scan Type.....	21
■ Inserting a microSD card.....	3	◇ VFO scan.....	21
■ Turning ON the receiver.....	3	◇ Memory scan.....	21
■ Adjusting the audio level.....	3	◇ Tone scan.....	21
■ Saving the setting data onto a	4	■ Starting or canceling the scan.....	22
microSD card.....	4	■ Program Skip function.....	22
◇ Formatting a microSD card.....	4	6 RECORDING AND PLAYING BACK..	23
◇ Saving the setting data.....	5	■ About the microSD card.....	23
2 PANEL DESCRIPTION.....	6	■ Recording.....	24
■ Front, top, and side panels.....	6	◇ Starting recording.....	24
■ Function display.....	8	◇ Stopping recording.....	24
		■ Playing a recorded audio.....	25
		■ Removing the microSD card.....	25
		◇ Removing while the receiver	25
		is OFF.....	25
		◇ Removing while the receiver	26
		is ON.....	26

■	Table of contents	
7	OTHER FUNCTIONS	27
■	Bluetooth® operation	27
■	Turning ON the Bluetooth® function	27
■	Connecting to a Bluetooth® device	28
■	Disconnecting a Bluetooth® device	29
■	Initializing the installed Bluetooth® unit	29
■	Using the Automatic Noise Limiter (ANL)	30
■	Using the Voice Squelch Control (VSC)	30
8	MAINTENANCE	31
■	Resetting	31
◇	Partial Reset	31
■	Troubleshooting	32
9	SIMPLE MODE	34
■	About the Simple mode	34
◇	Using the Simple mode	34
◇	Key operations in Simple mode	34
■	Receiving	35
◇	Selecting from the Favorite channel	35
◇	Selecting from the Category/Group	35
◇	Selecting from the band	35
■	Listening to the FM Radio	36
◇	Selecting from the Radio Memory	36
◇	Selecting from the frequency	36
■	Scanning	37
10	SPECIFICATIONS	38
◇	General	38
◇	Receiver	39
◇	Bluetooth	39
	MENU SCREEN ITEMS	40
	INDEX	42
	ABOUT THE LICENSES	44

■ Attaching the supplied accessories

◇ Battery pack

NOTE:

- **BE CAREFUL!** Do not break your finger nail.
- Even when the receiver is OFF, a small current still flows in the receiver. Remove the battery pack or case from the receiver when not using it for a long time. Otherwise, the batteries in the pack or the case will become exhausted.

Attach the battery pack as shown to the right. (1→2)

- ① Turn OFF the receiver before attaching or detaching the battery pack.
- ① To detach, unhook the latch and then lift up the battery pack.

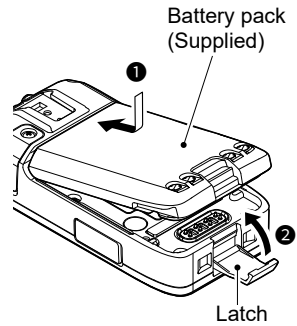

◇ Antenna

Connect the supplied antenna to the connector. This receiver has an SMA type antenna connector.

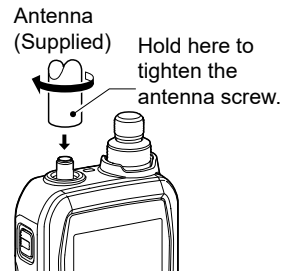

◇ Hand strap

⚠ WARNING! NEVER swing the receiver by holding the hand strap. This can cause injury to yourself or others.

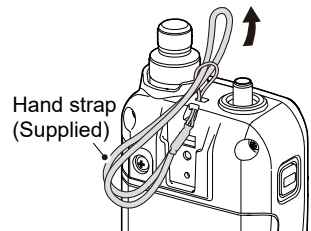

◇ Belt clip

To attach the belt clip, slide the clip in the direction of the arrow until it locks in place and makes a 'click' sound. To detach the belt clip, lift the tab up (1) and slide the belt clip in the direction of the arrow (2).

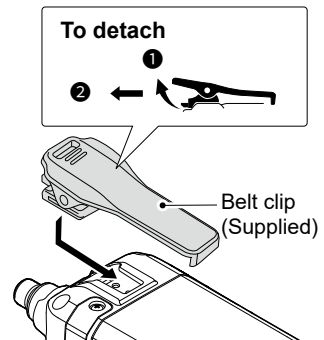

1 PREPARATION

■ Charging the battery pack

Charging time: Approximately 4 hours with 5V/1A input

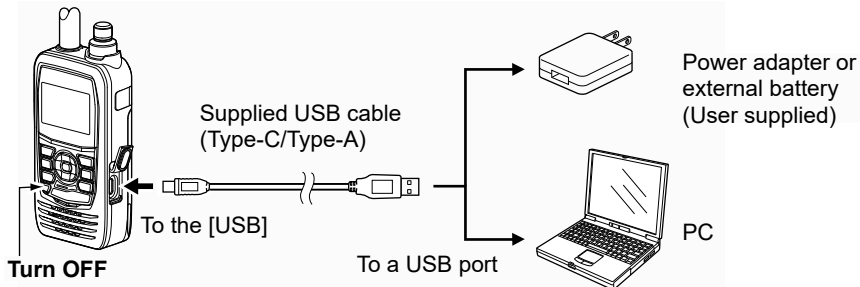

① See the Advanced manual about the optional battery packs and chargers.

NOTE:

- USB Power Delivery (USB PD) is not supported.
- Before using the receiver for the first time, the battery pack must be fully charged for optimum life and operation.
- **BE SURE** to turn OFF the receiver while charging. Otherwise, the attached battery pack cannot be charged.
- While charging, the charging icon “” and “Charging....” are displayed.
- The icon and “Charging....” disappear when the battery pack is fully charged.
- You may not be able to charge:
 - Depending on your USB cable or power adapter.
 - When using a USB hub or connecting to a low output USB port.
- Charging time may differ, depending on the USB port.

◇ Capacity of the battery pack

ICON	BATTERY STATUS
	The battery has sufficient capacity.
	The battery is exhausted a little.
 (green)	The battery is nearing exhaustion.
 (red)	The battery is almost fully exhausted. ① Immediately charge the battery pack. Otherwise, the icon will soon start blinking, “LOW BATTERY” will be displayed, and the receiver will automatically turn OFF.

■ Inserting a microSD card

Refer to page 23 for the usable microSD cards.

1. Turn OFF the receiver.
2. Pull down the [microSD] slot cover on the side panel.
3. With the terminals facing the front, insert the card into the slot until it locks in place and makes a 'click' sound.
 - ① When removing, push in the microSD card until a 'click' sounds. The card is unlocked, and you can pull it out.

CAUTION:

- **DO NOT** touch the terminals.
- **DO NOT** remove the card from the receiver while the card is being accessed. Otherwise, the card data may be corrupted or deleted.

4. Completely close the [microSD] slot cover.

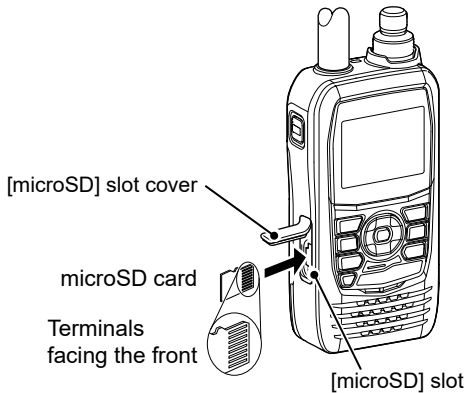

CAUTION: DO NOT forcibly or inversely insert the card. It will damage the card or the slot.

■ Turning ON the receiver

- Hold down [⏻] for 1 second to turn ON the receiver.
 - After the opening message and the remaining battery capacity are displayed, the receiving frequency is displayed.
- Hold down [⏻] for 1 second again to turn OFF the receiver.

■ Adjusting the audio level

- Rotate [VOL] to adjust the audio level.
 - ① The display shows the audio level while adjusting.

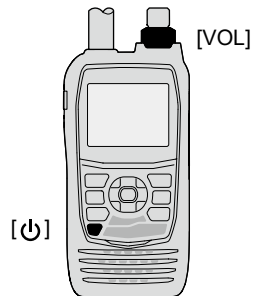

1 PREPARATION

■ Saving the setting data onto a microSD card

You can save the Memory channels, MENU screen item settings, repeater lists, and so on onto a microSD card.

Saving settings onto a card lets you easily restore the receiver to its previous settings, even if you perform an All Reset.

◇ Formatting a microSD card

IMPORTANT! Before using a microSD card for the first time, format it in the receiver. Formatting a card erases all its data. Before formatting any used card, back up its data onto another device.

[MENU] > SET > SD Card > **Format**

1. Turn ON the receiver.
 - If a microSD card is inserted, the microSD icon “SD” is displayed.
 - While accessing, the icon blinks.
 2. Push [MENU].
 3. Select “SD Card” in the “SET” menu.
 4. Select “Format.”
 - The confirmation dialog is displayed.
 5. Select “YES.”
 - The formatting starts, and the display shows the formatting progress.
 - After the formatting ends, return to the SD CARD screen.
- ① To exit the MENU screen, push [MENU].

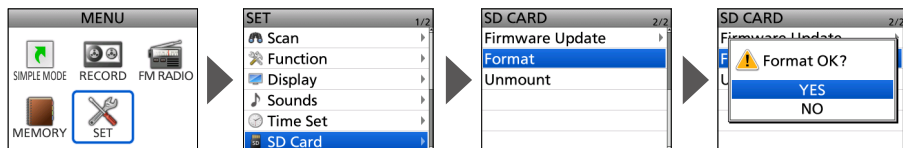

◇ Saving the setting data

[MENU] > SET > SD Card > **Save Setting**

1. Push [MENU].
2. Select “SD Card” in the “SET” menu.
3. Select “Save Setting.”
4. Select “<<New File>>.”
 - The FILE NAME screen is displayed.
 - ① The file name is automatically set in the following format:
Set YYYYMMDD_XX (YYYY: Year, MM: month, DD: day, XX: serial number).
5. Push [ENT] to save the file with the displayed name.
 - The confirmation dialog is displayed.
6. Select “YES.”
 - Saves the setting data.
 - While saving, a progress bar is displayed, then returns to the SD CARD screen after the saving is completed.
 - ① To exit the MENU screen, push [MENU].

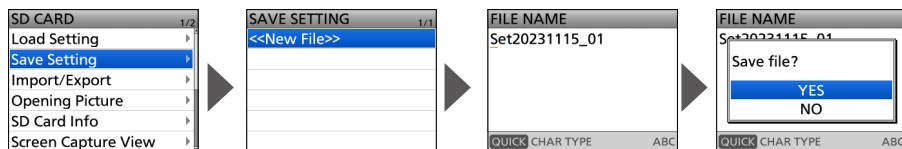

TIP: You can edit the saved settings on your PC using the optional CS-R15 PROGRAMMING SOFTWARE.

■ Front, top, and side panels

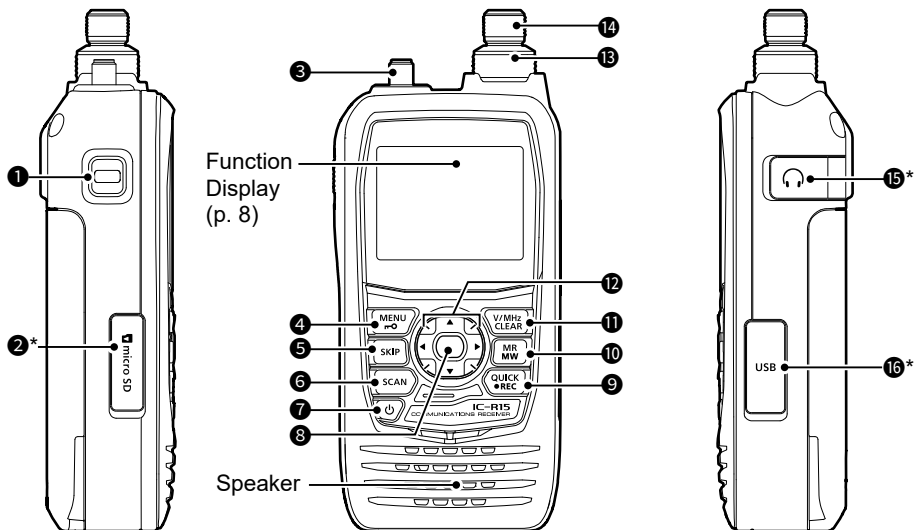

*Close the covers firmly when not in use.

① SQUELCH KEY [SQL]

- While pushing, rotate [DIAL] to adjust the squelch level. (p. 14)
- Push or hold down to turn the Monitor function ON or OFF. (p. 14)

② microSD CARD SLOT [microSD]

Insert a microSD card (User supplied). (p. 3)

③ ANTENNA CONNECTOR

Connect the supplied antenna.

④ MENU • LOCK KEY [MENU]/[

- Push to open the MENU screen. (p. 10)
- Hold down for 1 second to turn the Lock function ON or OFF. (p. 17)

⑤ SKIP KEY [SKIP]

- While the VFO scan is paused, push to enter a Skip channel group or a Temporary skip frequencies.
- In the Memory mode, push to enter a Skip channel (SKIP or PSKIP).
- While the Memory scan is paused, push to enter a Skip channel (SKIP or PSKIP) or the Temporary skip frequencies.

⑥ SCAN KEY [SCAN]

- Push to open the Scan type Select window. (p. 22)
- Hold down for 1 second to start the last selected scan.

7 POWER KEY [⏻]

- Hold down for 1 second to turn the receiver ON or OFF. (p. 3)
- When “Screen Capture [PWR] Key” is set to “ON,” push to capture the receiver screen onto a microSD card.
([MENU] > SET > Function > **Screen Capture [PWR] Key**)

8 ENTER KEY [ENT]

Push to set the selected item or option.

9 QUICK MENU • RECORDING KEY [QUICK]/[•REC]

- Push to open the Quick Menu window. (p. 12)
- Hold down for 1 second to start or stop the voice recording. (p. 24)

10 MEMORY • SELECT MEMORY WRITE KEY [MR]/[MW]

- Push to enter the Memory mode.
- Hold down for 1 second to open the Memory Write window.

11 VFO/MHz • CLEAR KEY [V/MHz]/[CLEAR]

- Push to enter the VFO mode. (p. 15)
- In the VFO mode, push to select 1 MHz tuning steps. (p. 16)
- In the MENU screen, push to select an upper-tier menu. (p. 10)
- Push to delete an entered character.

12 D-PAD (UP)/(DOWN)/(LEFT)/(RIGHT) KEYS

D-pad(↑)/D-pad(↓)

- Push to change the MAIN band. (p. 13)
- In the MENU screen or the Quick Menu window, push to move the option or value selector bar up. (p. 10, 12)
- Hold down for 1 second to turn the Dualwatch function ON or OFF. (p. 13)

D-pad(←)/D-pad(→)

- Push to select the receive band or the Memory group. (p. 16)
- In the MENU screen, push to select a menu item. (p. 11)

13 VOLUME CONTROL [VOL]

Rotate to adjust the audio level. (p. 3)

14 CONTROL DIAL [DIAL]

- Rotate to select an operating frequency. (p. 15)
- In the Memory mode, rotate to select a Memory channel. (p. 15)
- Rotate to select a setting item or value. (p. 10, p. 12)
- In the Character Entry mode, rotate to enter characters.

15 SPEAKER JACK [🎧]

Connect an optional earphone.

Speaker plug: 3.5 mm (1/8 inch)

- ① Confirm that the receiver is OFF before connecting or disconnecting optional equipment.

16 USB PORT (Type-C) [USB]

Connects to an external power source, a PC, or other USB devices.

- ① Not compatible with USB Power Delivery.

2 PANEL DESCRIPTION

■ Function display

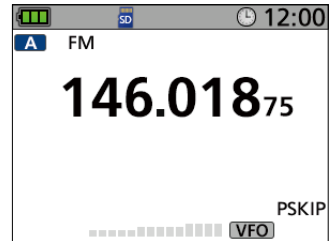
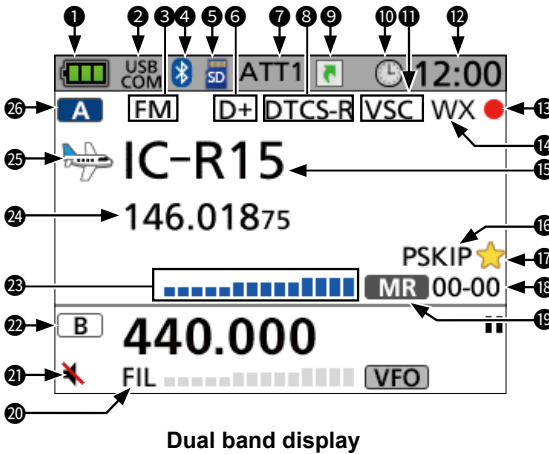

Single band display

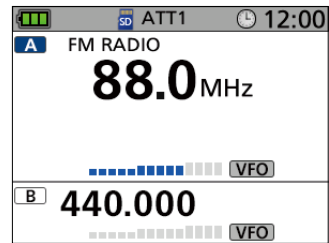

FM Radio mode on the A band

① BATTERY ICON

Displays the current capacity of the attached battery pack.

① “” is displayed when the optional battery case is attached.

② USB CONNECTION INDICATOR

Displayed when a USB device is connected through a USB cable, and “USB Connect” is set to “Serialport.” ([MENU] > SET > Function > **USB Connect**)

③ RECEIVE MODE ICONS

Displays the selected receive mode. (p. 15)

④ Bluetooth® ICON

Displayed when a Bluetooth device is connected. (p. 28)

⑤ microSD ICON (p. 4)

- Displayed when a microSD card is inserted.
- Blinks while accessing the microSD card.

⑥ DUPLEX ICONS

- D+: Displayed during plus duplex operation.
- D-: Displayed during minus duplex operation.

⑦ ATTENUATOR ICON

Displayed when the attenuator is ON. (p. 17)

⑧ TONE ICONS

Displayed when the tone function is ON.

⑨ SIMPLE MODE ICON

Displayed when operating in the Simple mode. (p. 34)

⑩ AUTO POWER OFF ICON



Displayed when the Auto Power OFF function is ON.

11 VSC/FM RADIO ATTENUATOR ICONS

- VSC: Displayed when the Voice Squelch Control function is ON.
- ATT: Displayed when the attenuator is ON in the FM Radio mode.

12 CLOCK DISPLAY

13 RECORD ICONS (p. 24)

-  : Displayed while recording.
-  : Displayed while recording is paused.

14 WEATHER ALERT ICON (p. 15)

Displayed when the Weather Alert function is ON. (For only the USA version)

15 MEMORY NAME DISPLAY

Displays the memory name, if entered. (p. 18)

16 SKIP ICONS

- SKIP: Displayed when Memory Skip is selected.
- PSKIP: Displayed when Program Skip is selected.

17 FAVORITE CHANNEL



Displayed when a Favorite channel is selected.

18 MEMORY CHANNEL NUMBER

Displays the selected Memory group and Memory channel number.

19 MODE ICON

Displayed the Frequency Selecting mode.

-  : VFO mode
-  : Memory mode
-  : Weather Channel mode (For only the USA version)



20 AF FILTER ICON

Displayed when the AF filter function is ON. (p. 17)

21 SUB BAND MUTE

Displayed when “Sub Band Mute” is set to “Mute” or “Mute & Beep”.
([MENU] > SET > Sounds > **Sub Band Mute**)

22 B BAND ICON

-  : Displayed when the B band is the MAIN band.
-  : Displayed when the B band is the SUB band.

23 S METER

Displays the relative signal strength of the received signal.



24 FREQUENCY READOUT

Displays an operating frequency.

25 CATEGORY ICON

Displayed the selected category icon. (p. 18)

26 A BAND ICON

-  : Displayed when the A band is the MAIN band.
-  : Displayed when the A band is the SUB band.

■ MENU screen

You can open the MENU screen by pushing [MENU].

You can use the MENU screen to set infrequently changed values or function settings.

See the appendix for the MENU item list.

For details of each item, see the Advanced manual.

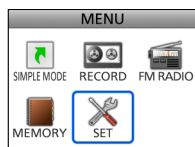

TIP: The MENU screen is constructed in a tree structure. You may go to the next tree level, or go back a level, depending on the selected item.

◇ MENU screen operation

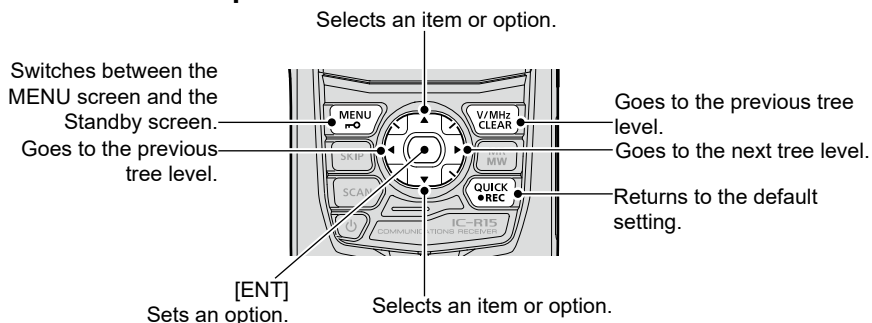

① On the MENU screen, you can select an item by pushing D-pad(↑↓←→).

Simplified description—'Select' operation

In this manual, user's 'Select' operation is simplified, as described below.

Simplified description:

1. Push [MENU].
2. Select "30min."

Operation:

1. Push [MENU] to open the MENU screen.
2. Push D-pad(↑↓) to select "30min," and then push [ENT].

◇ Selecting a Menu item

Example: Set “Auto Power OFF” to “30 min.”

[MENU] > SET > Time Set > **Auto Power OFF**

1. Push [MENU].
2. Select “SET.”
3. Select “Function.”
4. Select “Auto Power OFF.”
5. Select “30min.”
 - Sets the option, then goes back to a tree level. (The FUNCTION screen is displayed.)
 - ① To exit the MENU screen, push [MENU].

The Auto Power OFF icon is displayed.



TIP: To return to the default setting

1. Push [QUICK] in step 5.
2. Select “Default.”
 - The setting returns to the default.

① The default settings of each item are described in the Advanced manual.

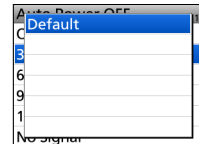

3 BASIC OPERATION

■ Quick Menu window

You can open the Quick Menu window by pushing [QUICK]. In the window, the selectable items may differ, depending on the receive mode or function. The items listed below are examples.



[QUICK]

VFO mode	Memory mode	Weather CH mode*2
Select Band	Favorite Mode	Weather Alert
MODE	Select Category/Group	Battery Status
DUP	Memory Selection Range	<<Start REC>>
TONE*1	MODE	<<FM Radio Mode>>*3
VSC*1	DUP	<<B Band>>*4
TS	TONE*1	<<Dualwatch OFF>>*5
ATT	VSC*1	
AF Filter	TS	FM Radio mode
Weather Alert*2	ATT	Select Group*6
Battery Status	AF Filter	SKIP*6
<<Start REC>>	Add to Favorites	SKIP Select Mode*6
<<FM Radio Mode>>*3	SKIP	ATT
<<B Band>>*4	Weather Alert*2	FM Radio ATT
<<Dualwatch OFF>>*5	Battery Status	Weather Alert*2
	<<Start REC>>	Battery Status
	<<FM Radio Mode>>*3	<<Start REC>>
	<<B Band>>*4	<<Exit FM Radio Mode>>
	<<Dualwatch OFF>>*5	<<B Band>>*4
		<<Dualwatch OFF>>*5

*1 For only FM/FM-N.

*2 For only the USA version.

*3 For only A band.

*4 When the B band is the MAIN band, "<<A Band>>" is displayed.

*5 When the Dualwatch function is OFF, "<<Dualwatch ON>>" is displayed.

*6 For only the FM Radio memory mode.

Dualwatch operation

The Dualwatch function simultaneously monitors 2 frequencies. The IC-R15 has 2 independent receiver circuits, A and B bands. You can set different frequencies or receive modes in each band.

- ① When the Dualwatch function is ON, the audio output may be interrupted when the frequency is switched while scanning, or by other factors. (p. vii)
- ① The FM Radio mode can be selected only for the A band.

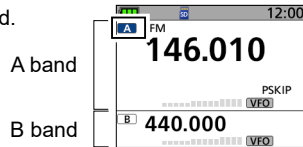

Dual band display
(The Dualwatch function is ON)

Turning Dualwatch ON or OFF

Hold down D-pad(↑) for 1 second to turn the Dualwatch function ON or OFF.

- When the Dualwatch function is ON, the display shows the A band in the upper half and the B band in the lower half of the display.
 - ① **A** or **B** is displayed on the MAIN band, where you can change the settings.
 - ① The SUB band can be automatically muted. ([MENU] > SET > Sounds > **Sub Band Mute**)
When you select, "Mute" or "Mute & Beep," is displayed.
- When the Dualwatch function is OFF, the display shows only the MAIN band. Push D-pad(↑) to select the other band.



Single band display
(The Dualwatch function is OFF)

MAIN band selection

Push D-pad(↑) to alternately set the A or B bands as the MAIN band.

- **A** or **B** is displayed on the MAIN band, where you can change the settings.
- ① Band selection, receive frequency setting, receive mode selection, Memory channel selection, and the Memory Write operation can be made only on the MAIN band.

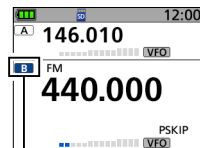

B band is set as the MAIN band.

3 BASIC OPERATION

■ Setting a squelch level

Noise squelch enables the audio to be heard only while receiving signals that are stronger than the set level. A higher level blocks weak signals, and receives only stronger signals. A lower level receives weaker signals.

① Throughout this document, “Noise squelch” is called simply “Squelch.”

While holding down [SQL], rotate [DIAL] to select the squelch level.

① Information

- Options: “OPEN,” “AUTO” (default), and “LEVEL 1” ~ “LEVEL 9.”
- “LEVEL 1” is a loose squelch (for weak signals) and “LEVEL 9” is a tight squelch (for strong signals).
- “AUTO” is an automatic level adjustment using a noise pulse counting system.
- “OPEN” is the continuously open setting.
- In the FM Radio mode, you can adjust up to “LEVEL 3”.

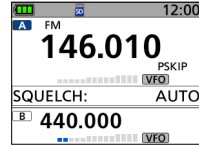

Automatic squelch

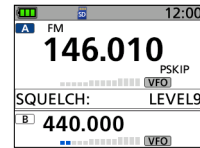

Maximum squelch level

■ Monitor function

The Monitor function is used to listen to weak signals without changing the squelch setting.

While holding down [SQL], you can hear weak signals on the frequency.

TIP: You can set the Monitor Hold function on the MENU screen. The receiver opens or closes the squelch each time you push [SQL].
([MENU] > SET > Function > **Monitor**)

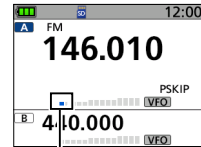

The first segment blinks.

■ Receiving

◇ Selecting the Frequency Selecting mode

VFO mode

Rotate [DIAL] to set an operating frequency.

① In the VFO mode, **VFO** is displayed.

Memory mode

Select a Memory channel where an operating frequency and other parameters are saved.

① In the Memory mode, **MR** and the Memory Channel number are displayed.

Weather Channel mode (For only the USA version)

Weather Channels are used for monitoring Weather Channels from the National Oceanographic and Atmospheric Administration (NOAA) broadcasts.

① In the Weather Channel mode, **WX** is displayed.

FM Radio mode

You can listen to FM Radio broadcasts.

1. Select a mode.

① Information

- Push [V/MHz] to select the VFO mode.
- In the VFO mode, push [V/MHz] to select the 1 MHz tuning step.
- Push [MR] to select the Memory mode.
- For only the USA version, push [MR] in the Memory mode to select the Weather Channel mode.
- Push [QUICK], and then select “<<FM Radio Mode>>” to turn ON the FM radio.

2. Rotate [DIAL] to select an operating frequency or a channel.

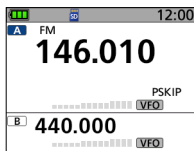

VFO mode

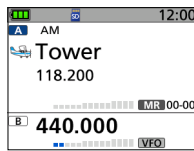

Memory mode

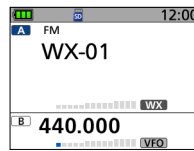

Weather Channel mode

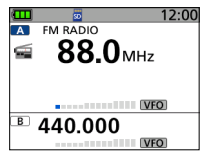

FM Radio mode

◇ Selecting the receive mode

1. Push [QUICK] to select the receive mode.
2. Select “MODE.”
 - ① The receiver has 4 receive modes, FM, FM-N, AM, and AM-N.



FM mode

3 BASIC OPERATION

■ Receiving

◇ Selecting the receive band

1. Push [V/MHz] to select the VFO mode.
 2. Push [QUICK].
 3. Select "Select Band."
 4. Select the receive band.
 - Sets the receive band, then returns to the Standby screen.
- ① In the VFO mode, you can also change the band by pushing D-pad(⇐).

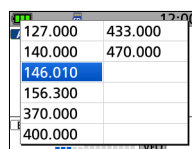
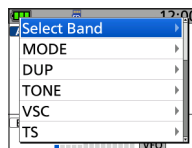

■ Setting a frequency

You can select an operating frequency by rotating [DIAL].

- ① When receiving a signal, the S-meter displays the received signal strength.

◇ Selecting the 1 MHz tuning

You can change the operating frequency in 1 MHz steps for quick tuning.

1. In the VFO mode, push [V/MHz].
 - Enters the 1 MHz Tuning Select mode, and the 1 MHz digit blinks.
 2. Rotate [DIAL].
 - The frequency changes in 1 MHz steps.
 3. Push [V/MHz].
 - Exits the 1 MHz Tuning Select mode.
- ① The tuning step setting (above) remains.

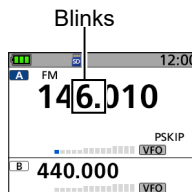

The 1 MHz Tuning Select mode

◇ Selecting a tuning step

When you select the frequency by rotating [DIAL] in the VFO mode, it changes in the selected tuning step.

1. Push [QUICK].
2. Select "TS."
3. Select a tuning step.

Options (kHz):

5.0	6.25	8.33*	10.0	12.5	15.0	20.0
25.0	30.0	50.0	100.0	125.0	200.0	

* For only VHF AIR band (108.000 MHz ~ 136.991 MHz).

• Sets the tuning step, then returns to the Standby screen.

- ① You can set the tuning step for both the VFO and Memory mode.
- ① The VFO mode scan and the Band Scope function also use this step to search for signals.

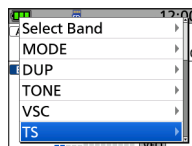

■ Attenuator

The Attenuator prevents a desired signal from becoming distorted when a powerful signal is near the frequency, or when a powerful electric field, such as from a broadcasting station, is near your location.

- ① These settings can be separately set in A band and B band.
- 1. Push [QUICK].
- 2. Select "ATT."
- 3. Set the Attenuator level to between "ATT1" and "ATT4."
 - ① The higher the level, the larger the attenuation amount becomes.



When set to ATT4

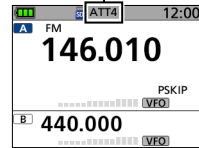

■ Lock function

Activate to prevent accidental frequency changes and unnecessary function access.

Hold down [LOCK] for 1 second to turn ON the Key Lock function.

- When the Key Lock function is ON, and the locked key or [DIAL] is pushed or rotated, "LOCK ON" is displayed.

① Information

- To turn OFF the function, hold down [LOCK] for 1 second again (Until "LOCK OFF" is displayed).
- [SQL], [SQL], and [VOL] can be used even if the Key Lock function is ON.
- You can change the keys to be locked on the MENU screen. ([MENU] > SET > Function > Key Lock)

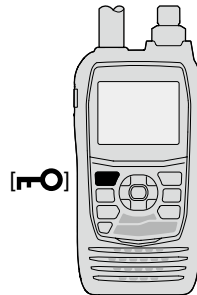

■ AF Filter function

The AF Filter suppresses high-pitch tones.

- ① This function can be separately set for each band and receive mode.
- 1. Push [QUICK].
- 2. Select "AF Filter."
- 3. Select "ON."
 - "FIL" is displayed.

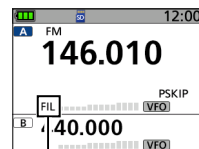
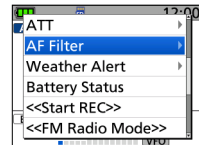

"FIL" is displayed.

■ Selecting a Memory channel

In the Memory mode, you can select the Memory channels by rotating [DIAL].

- ① The memory contents on the screen may differ, depending to the presetting.
1. Push [MR] to enter the Memory mode.
 - ① For only the USA version, pushing [MR] alternately selects the Memory and Weather Channel modes.
2. Rotate [DIAL].
 - Selects a Memory channel.
 - ① To select the Memory group, push [QUICK] and select “Select Category/Group.”
 - ① Blank channels are not selected.

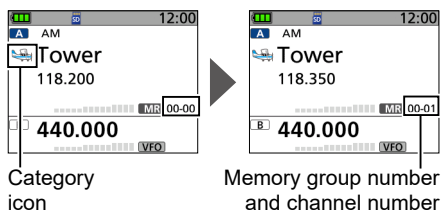

TIP: To sequentially select a channel in a different group
Set “Memory Selection Range” to “All Groups” in the Quick Menu window.

■ Viewing the Memory channel contents

You can view the Memory channel contents on the MEMORY screen.

Example: Viewing the contents of Channel 00 of Group 00 in the Airband category.

[MENU] > MEMORY > **Memory CH**

1. Push [MENU].
2. Select “MEMORY” on the MENU screen.
3. Select “Memory CH.”
4. Select “Airband.”
5. Select Group “00.”
6. Select Channel “00.”
 - Channel contents are displayed.
 - ① Rotate [DIAL] to scroll the screen.
 - ① To exit the MENU screen, push [MENU].

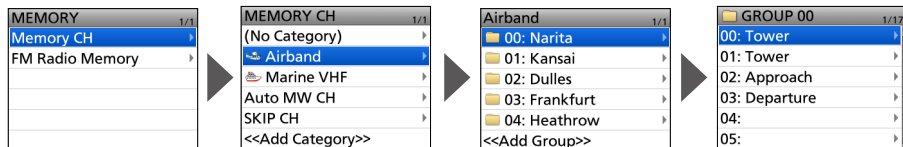

◇ About the Memory channel contents

(Example)

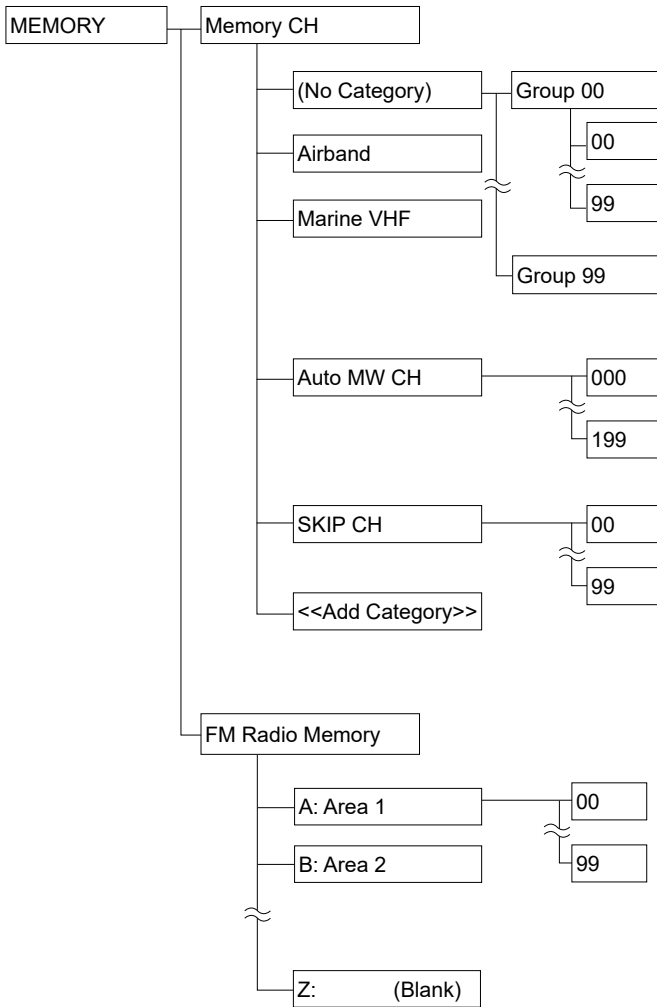

4 MEMORY OPERATION

■ Entering Memory channels

The receiver has a total of 2,000 Memory channels to save often-used frequencies. In the Memory mode, you can quickly select the saved memories. This section describes the basic channel content entry.

Example: Entering 146.030 MHz/FM mode into Channel 02 in Group 06 (No Category).

1. Hold down [MW] for 1 second.
 - A short and a long beep sound.
2. Select "Write to New CH."
3. Push [QUICK].
4. Select "Select Category/Group."
5. Select "(No Category)."
6. Select Group "06."
7. Rotate [DIAL] to select Channel "02."
8. Push [ENT].
 - The confirmation dialog is displayed.
9. Select "YES."
 - Beeps sound, and the Memory contents are briefly displayed, then returns to the VFO mode.

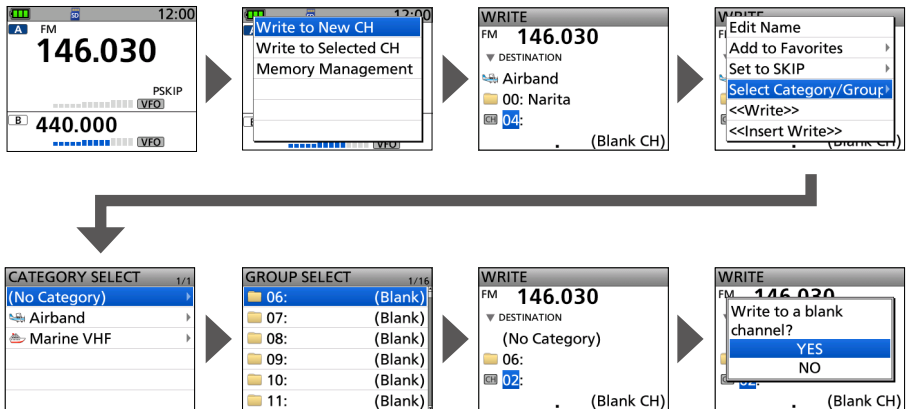

① See the Advanced manual for more details on the scanning.

■ Scan Type

Scanning is a versatile function that can automatically search for signals. A scan makes it easier to locate stations to contact or listen to, or to skip unwanted channels or frequencies.

◇ VFO scan

The VFO scan searches for signals within the specified frequency range.

Scan type	Description
Program scan (P00 ~ P24)	Repeatedly scans the selected Program Scan range.
Program Link (P-LINK0 ~ 9)	Sequentially scans the Program Scan ranges. The links are set on the MENU screen. ([MENU] > SET > Scan > Program Link)
Band	Repeatedly scans the frequency band.
All bands	Repeatedly scans the entire band.
Auto MW	When a signal is received during a VFO scan, the frequency is automatically stored in an Auto Memory Write channel group (000 ~ 199).

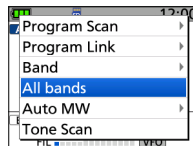

4
5

◇ Memory scan

The Memory scan searches signals on the preregistered memory channels.

Scan type	Description
Favorite	Sequentially searches through all Favorite memory channels.
Current Group	Scans the memory channels that are entered in the same group that is currently selected.
Group Link	Sequentially scans the memory groups which are set to link on the MENU screen.
Category/Group	Scans the memory channels in the selected category group.
ALL	Repeatedly scans all memory channels.

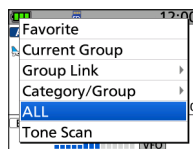

◇ Tone scan

The Tone scan searches for signals with tone frequencies or DTCS codes from stations using the Tone Squelch function.

① A Tone scan is usable for only FM/FM-N in the VFO or Memory scan.

5 SCANNING

■ Starting or canceling the scan

- ① Set the VFO mode or memory mode before starting the scan.
 1. Push [SCAN].
 - Opens the Scan Type Select window.
 - ① If you hold down [SCAN] for 1 second, the last selected scan starts.
 2. Select a scan type.
 - The scan starts.
 - In the VFO mode, the decimal point and the selected Scan Type icon blink.
 - In the Memory mode, the decimal point and the Memory icon blink.
 - ① When receiving a signal, the S-meter displays the received signal strength.
 - ① Rotate [DIAL] to change the scanning direction.
 3. Push [CLEAR] to cancel the scan.

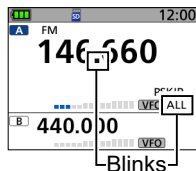
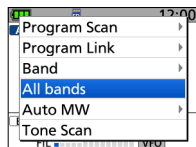

■ Program Skip function

This function enables the receiver to skip the unwanted frequencies that are entered as Memory channels and are set to “PSKIP.”

- ① Individually selectable for A band and B band.
 1. While the VFO scan is paused, push [SKIP].
 2. Select “Add to SKIP MR Group.”
 - Sets the frequency as a Skip Channel group.
 - The scan automatically resumes.
- ① When “Program Skip” is set to OFF, you cannot use the Program Skip scan function.
([MENU] > SET > Scan > **Program Skip**)

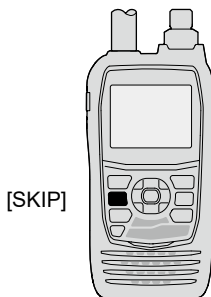

■ About the microSD card

NOTE: The microSD and microSDHC cards are not available from Icom (User supplied).

A microSD card of up to 2 GB, or a microSDHC of up to 32 GB, can be used in this receiver. Icom has checked the compatibility with the following cards. (As of February 2024)

Brand	Type	Memory size
SanDisk®	microSD	2 GB
	microSDHC	4 GB
		8 GB
		16 GB
		32 GB

- ① The performance of the cards listed to the left is not guaranteed.
- ① Throughout this document, the microSD card and microSDHC card are simply called the microSD card or the card.
- ① Before using the microSD card, format it using the receiver, even a preformatted card for PCs or other uses. (p. 4)

TIP: Saving the factory default data is recommended. (p. 5)
 ([MENU] > SET > SD Card > **Save Setting**)

NOTE:

- Before using the microSD card, thoroughly read the instructions of the card.
- If you do any of the following, the card data may be corrupted or deleted.
 - You remove the card from the receiver while accessing the card.
 - You change the external power supply's voltage while accessing the card.
 - You drop, impact, or vibrate the card.
- **DO NOT** touch the contacts of the card.
- The receiver takes a longer time to access a higher-capacity card.
- The card will get warm if used continuously for a long period of time.
- The card has a certain lifetime, so data reading or writing may not be possible after using it for a long period of time.
- When reading or writing data is impossible, the card's lifetime has ended. In this case, purchase a new one. We recommend you make a backup file of the important data onto your PC.
- Icom will not be responsible for any damage caused by data corruption of a card.

6 RECORDING AND PLAYING BACK

■ Recording

NOTE: Once a voice recording starts, the Recording function will stay turned ON until you stop recording, even if you turn OFF the receiver.

◇ Starting recording

- Hold down [●REC] for 1 second.
 - “Recording started.” is displayed.

① Information

- The function records the audio on both the MAIN and SUB band when the Dualwatch function is ON.
- The function records the audio on the displayed band (A or B), when a single band display is selected.
- ● is displayed while recording.
- ■■■ is displayed while the recording is paused.
- Recording continues until you stop recording, or the card becomes full.
- You can also record the audio in the Quick Menu window.

◇ Stopping recording

- Hold down [●REC] for 1 second again.
 - “Recording stopped.” is briefly displayed, and voice recording stops.
 - ① In the Quick Menu window, selecting <<Exit FM Radio Mode>> also stops the recording.

TIP: As the default setting

The recording is paused while the squelch is closed, and resumes when a signal is received. ([MENU] > RECORD > Recorder Set > **RX REC Condition**)

■ Playing a recorded audio

[MENU] > RECORD > Play Files

1. Push [MENU].
2. Select "Play Files" in the "RECORD" menu.
3. Select the folder that contains the file you want to play.
 - ① The folder is named YYYYMMDD (Y: year, M: month, D: day).
4. Select the file that you want to play.
 - The VOICE PLAYER screen is displayed and starts playing.
 - ① To pause, push [ENT]. To restart, push [ENT] again.
5. Push [CLEAR] to stop playing.
 - The file list is displayed.
 - ① To exit the MENU screen, push [MENU].

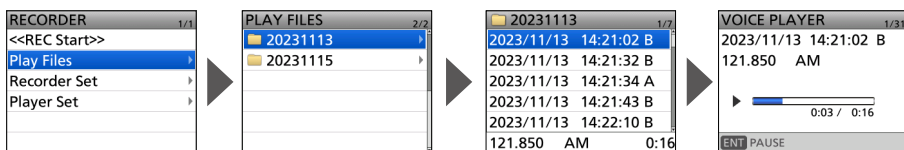

6

■ Removing the microSD card

◇ Removing while the receiver is OFF

1. Turn OFF the receiver.
2. Open the [microSD] slot cover.
3. Push in the microSD card until a 'click' sounds, and then carefully pull it out.
 - ① **DO NOT** touch the terminals.
4. Completely close the [microSD] slot cover.

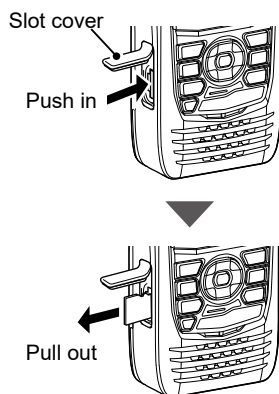

6 RECORDING AND PLAYING BACK

■ Removing the microSD card

◇ Removing while the receiver is ON

[MENU] > SET > SD Card > **Unmount**

1. Push [MENU].
2. Select "SD Card" in the "SET" menu.
3. Select "Unmount."
 - The confirmation dialog is displayed.
4. Select "YES."
 - When the unmounting is completed, "Unmount is completed." is briefly displayed, then the display automatically returns to the SD CARD screen.
5. Push in the microSD card until a 'click' sounds, and then carefully pull it out.
 - ① See "Removing while the receiver is OFF" for details.
6. Completely close the [microSD] slot cover.

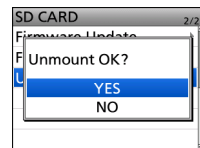
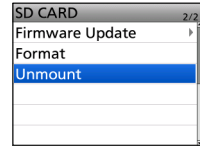

NOTE: After removing the microSD card, completely close the [microSD] slot cover as shown to the right.

Close the slot cover firmly



YES

NO

■ Bluetooth® operation

The receiver has a built-in Bluetooth unit and you can connect to Bluetooth devices. When you connect a Bluetooth device to the receiver, you can wirelessly use it. Refer to the Advanced manual for more details on the Bluetooth function.

- ① Only 1 Bluetooth device can be paired.
- ① The communication range of Bluetooth is approximately 10 meters (33 feet).

IMPORTANT: The Bluetooth communication range may vary, depending on the environment in which the device operates. Microwave ovens or Wireless LAN may cause interference. In that case, stop using those devices or increase the space between the Bluetooth device and the other devices. All Bluetooth devices have a range of use. If the communication is unstable, use the device within the range.

NOTE: Connect with a device that complies with the standards set by Bluetooth SIG and has been certified.

Even if the device complies with the Bluetooth standard, it may not be able to connect to the receiver, depending on the specifications and settings of the device, and not all operations are guaranteed.

6

7

■ Turning ON the Bluetooth® function

[MENU] > SET > Bluetooth Set > **Bluetooth**

1. Push [MENU].
 2. Select "Bluetooth Set" in the "SET" menu.
 3. Select "Bluetooth."
 4. Select "ON."
- ① To exit the MENU screen, push [MENU].

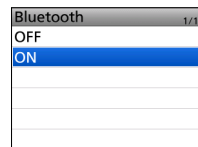
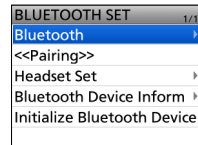

7 OTHER FUNCTIONS

■ Connecting to a Bluetooth® device

Step 1. Selecting the pairing mode of the device.

See the instruction manual of the device to select the pairing mode.

Step 2. Searching for the device (Receiver)

[MENU] > SET > Bluetooth Set > <<Pairing>>

1. Push [MENU].
2. Select "Bluetooth Set" in the "SET" menu.
3. Select "<<Pairing>>".
 - The receiver starts searching.
 - When the pairable devices are found, their names are displayed on the window.
 - ① If you select "<<Pairing>>" again, you can delete a paired Bluetooth device.
4. To exit the MENU screen, push [MENU].
 - ① While connected to a Bluetooth device, the Bluetooth icon is displayed on the Standby screen.
 - ① When "AF Output" is set to "Headset Only" and the Bluetooth connection is accidentally disconnected, a dialog is displayed to select whether or not to output the audio from the receiver's speaker.

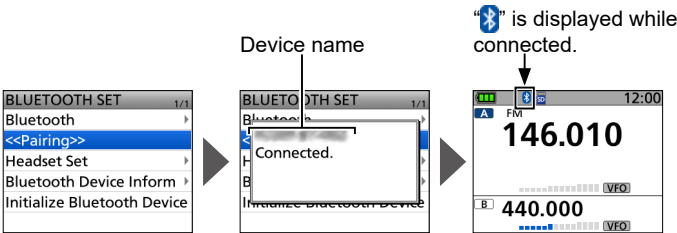

■ Disconnecting a Bluetooth® device

You can disconnect a paired Bluetooth device if it is not being used.

[MENU] > SET > Bluetooth Set > **Bluetooth**

1. Push [MENU].
2. Select "Bluetooth Set" in the "SET" menu.
3. Select "Bluetooth."
4. Select "OFF".
 - The confirmation dialog is displayed as shown to the right.
5. Select "YES" or "NO."
 - The Bluetooth icon disappears from the Standby screen.
6. To exit the MENU screen, push [MENU].

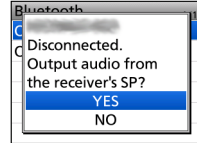

■ Initializing the installed Bluetooth® unit

You can initialize the receiver's Bluetooth unit.

You should initialize the unit if you have trouble during Bluetooth operation.

- ① After initializing the unit, the pairing device information is deleted, but the Bluetooth settings and the unit name remain.

The Bluetooth settings return to their factory defaults only when you do a Partial Reset or All Reset.

[MENU] > SET > Bluetooth Set > **Initialize Bluetooth Device**

1. Push [MENU].
2. Select "Bluetooth Set" in the "SET" menu.
3. Select "Initialize Bluetooth Device."
 - The confirmation dialog is displayed.
4. Select "YES."
 - The receiver will automatically restart.

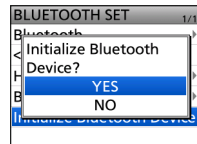
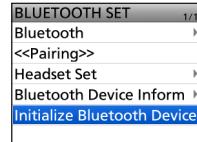

7 OTHER FUNCTIONS

■ Using the Automatic Noise Limiter (ANL)

The Automatic Noise Limiter function reduces noise components while receiving.

① The function is usable in the AM and AM-N modes.

[QUICK] > ANL

■ Using the Voice Squelch Control (VSC)

The Voice Squelch Control function opens the squelch or stops a scan only when voice components are detected in the signal. It is convenient to receive only voice communications.

① The function is usable in the FM and FM-N modes.

[QUICK] > VSC



Resetting

Occasionally, erroneous information is displayed when, for example, first applying power. This may be caused externally by static electricity or by other factors.

If this problem occurs, perform a Partial reset or an All reset.

BE CAREFUL! An All reset clears all programming and returns all settings to the factory defaults. See the Advanced manual for details.

① The Bluetooth pairing information and opening picture are not deleted.

◇ Partial Reset

[MENU] > SET > Others > Reset > **Partial Reset**

1. Push [MENU].
2. Select "Others" in the "SET" menu.
3. Select "Reset."
4. Select "Partial Reset."
 - The confirmation dialog is displayed.
5. Select "YES."
 - "PARTIAL RESET" is displayed, and then the display automatically returns to the default screen.

TIP: A Partial Reset resets the operating settings to their defaults without clearing the following:

- Memory Channel contents
- Scan Edge contents
- Radio Memory contents
- Opening picture



■ Troubleshooting

The following chart is designed to help you correct problems that are not equipment malfunctions. If you are unable to locate the cause of a problem or solve it through the use of this chart, contact your nearest Icom Dealer or Service Center.

① “AM” indicates the PDF type Advanced Manual.

The receiver does not turn ON.

- The battery is exhausted.
→ Charge the battery pack, or replace the batteries. (p. 2)
- Loose connection of a battery pack.
→ Clean the battery terminals.
- The battery polarity in the battery case is reversed.
→ Check the battery polarity in the case.

No sound comes from the speaker.

- The volume level is too low.
→ Rotate [VOL] to adjust the level. (p. 3)
- The squelch level is too high.
→ Adjust the squelch level. (p. 14)
- The Tone Squelch function is turned ON.
→ Turn OFF the function. (AM)
- An external speaker is connected to the [⏏] jack.
→ Check the external speaker connection.
- A Bluetooth device is connected.
→ Disconnect the device. (p. 29)

Sensitivity is too low, and only strong signals are heard.

- The coaxial cable is not connected or shorted (External antenna is used).
→ Check the coaxial cable connection or replace it with a new one.
- The Attenuator function is turned ON.
→ Turn OFF the attenuator. (p. 17)

Frequency cannot be set.

- The Key Lock function is activated.
→ Cancel the Key Lock function. (p. 17)
- The VFO mode is not selected.
→ Push [V/MHZ] to select the VFO mode. (p. 15)

The displayed frequency is erroneous.

- The CPU has malfunctioned.
→ Reset the receiver. (p. 31)
- External factors have caused a fault.
→ Remove and reattach the battery pack/case. (p. 1)

A Program Scan does not start.

- The VFO mode is not selected.
→ Push [V/MHz] to select the VFO mode. (p. 15)
- The same frequencies are entered into the scan edges.
→ Enter different frequencies into the scan edges. (AM)

A Memory Scan does not start.

- The Memory mode is not selected.
→ Push [MR] to select the Memory mode. (p. 15)
- Only one or no memory channel is entered.
→ Enter two or more memory channels. (p. 20)

A distorted noise is heard when the earphone is used.

- The earphone mode is OFF.
→ Turn ON the earphone mode on the MENU screen. (p. 41)

■ About the Simple mode

In the Simple mode, you can receive, scan, and listen to the FM radio by selecting from favorite channels, Categories/Groups, and so on.

① The memory contents on the screen may differ, depending to the presetting.

◇ Using the Simple mode

[MENU] > SIMPLE MODE

1. Push [MENU].
2. Select "SIMPLE MODE."
3. Select an item that you want to receive. (Example: Favorite)
 -  is displayed on the Standby screen.
 - ① To specialize in simple operations, the Simple mode is set to the single band display and restricts some operations.

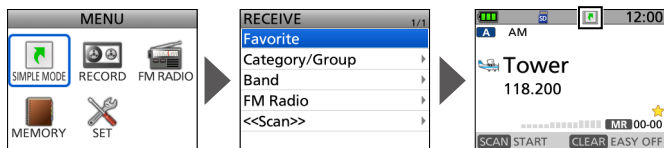

Display in the Simple mode

4. To exit the Simple mode, push [CLEAR].
 - The confirmation dialog is displayed.

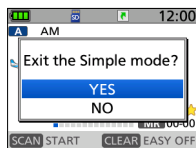

5. Select "YES."

◇ Key operations in Simple mode

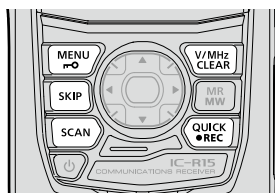

[MENU]/[

- Switches between the MENU screen and the Standby screen.
- Hold down for 1 second to turn the Lock function ON or OFF.

[SKIP]

Push to enter a Skip channel (SKIP or PSKIP).

[SCAN]

Push to start or stop a scan.

[V/MHz]/[CLEAR]

Push to exit the Simple mode.

[QUICK]/[

- Push to open the Quick Menu window.
- Hold down for 1 second to start the voice recording.

■ Receiving

◇ Selecting from the Favorite channel

[MENU] > SIMPLE MODE > Favorite

1. Push [MENU].
2. Select "SIMPLE MODE."
3. Select "Favorite" in the "RECEIVE" menu.
 - The receiver displays "Favorite Select Mode" and ★ is displayed.
4. Rotate [DIAL] to select a channel from Favorites.
 - ① You can add Favorite channels from the Quick Menu. (p. 12)



◇ Selecting from the Category/Group

[MENU] > SIMPLE MODE > Category/Group

1. Push [MENU].
2. Select "SIMPLE MODE."
3. Select "Category/Group" in the "RECEIVE" menu.
4. Select a group from the category list.
5. Rotate [DIAL] to select a channel.

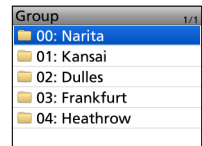
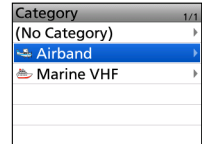

◇ Selecting from the band

[MENU] > SIMPLE MODE > Band

1. Push [MENU].
2. Select "SIMPLE MODE."
3. Select "Band" in the "RECEIVE" menu.
4. Select the frequency band.
5. Rotate [DIAL] to set a frequency.



■ Listening to the FM Radio

◇ Selecting from the Radio Memory

[MENU] > SIMPLE MODE > FM Radio > **FM Radio Memory**

1. Push [MENU].
2. Select "SIMPLE MODE."
3. Select "FM Radio" in the "RECEIVE" menu.
4. Select "FM Radio Memory."
5. Select a group.
 - "FM RADIO" and the Radio Memory name are displayed.
6. Rotate [DIAL] to select a channel.
 - ① Scanning is not activated.



"FM RADIO" and the Radio Memory name are displayed

◇ Selecting from the frequency

[MENU] > SIMPLE MODE > FM Radio > **Frequency**

1. Push [MENU].
2. Select "SIMPLE MODE."
3. Select "FM Radio" in the "RECEIVE" menu.
4. Select "Frequency."
 - "FM RADIO" and the Radio frequency are displayed.
5. Rotate [DIAL] to set a frequency.

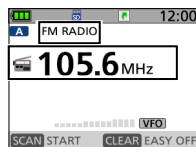

"FM RADIO" and the Radio frequency are displayed

■ Scanning

You can search for signals from Favorite channels, Categories/Groups, or bands.

[MENU] > SIMPLE MODE > <<Scan>>

1. Push [MENU].
2. Select "SIMPLE MODE."
3. Select "<<Scan>>" in the "RECEIVE" menu.
4. Select a Scan type.
 - **MR** or "BND" blinks and the scan starts.
 - ① When receiving a signal, the scan is paused and the S-meter displays the received signal strength.
 - ① Rotate [DIAL] to change the scanning direction.
 - ① While the scan is paused, push [SKIP] to temporarily skip unwanted frequencies (or memory channels) during a scan for the set period of time or condition without changing the Skip Channel setting.

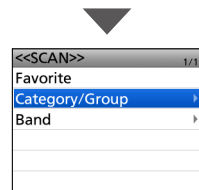
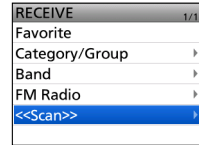

10 SPECIFICATIONS

◇ General

- Frequency coverage:
[A band], [B band] 108.000000 ~ 500.000000 MHz
[BC band (FM Radio)] EUR version 76.000000 ~ 108.000000 MHz
USA version 88.000000 ~ 108.000000 MHz
- Receive modes: FM/FM-N/WFM*¹/AM/AM-N
- Operating temperature range: -20°C ~ +60°C, -4°F ~ +140°F
- Frequency stability: ±2.5 ppm or less (-20°C ~ +60°C, -4°F ~ +140°F)
- Frequency resolution: 5, 6.25, 8.33*², 10, 12.5, 15, 20, 25, 30, 50, 100, 125, 200 kHz
- Number of memory channels: 2,000 (in 100 groups)
+ 325 (Scan edges: 25 pairs,
Auto Memory Write: 200, and Scan Skip: 100)
- Power supply requirement: 5.0 V DC (±5%) (Using the supplied USB cable)
3.6 V DC (Using the supplied battery pack)
4.5 V DC (Using the battery case)
- Antenna impedance: 50 Ω nominal Unbalanced
- Dimensions (Projections not included):
58 (W) × 116 (H) × 33.8 (D) mm,
2.3 (W) × 4.6 (H) × 1.3 (D) in
- Weight (approximate): 260 g, 9.2 oz
(Including battery pack and antenna)

*¹ For only the FM radio mode.

*² For only VHF AIR band (108.000 MHz ~ 136.991 MHz).

◇ Receiver

- Receive system: Double superheterodyne
- Intermediate frequencies:
 - [A band] 1st 58.050 MHz, 2nd 0.450 MHz
 - [B band] 1st 57.150 MHz, 2nd 0.450 MHz

- Sensitivity for all versions:

Mode	Frequency range (MHz)	Sensitivity (dBμ)	Squelch Sensitivity (dBμ)
AM (10 dB S/N)	108.000 ~ 142.000	0 or less	0 or less
	222.000 ~ 249.995	0 or less	0 or less
	250.000 ~ 299.995	5 or less	5 or less
	300.000 ~ 400.000	3 or less	3 or less
FM (12 dB SINAD) (1 kHz/±3.5 kHz DEV)	108.000 ~ 249.995	-8 or less	-8 or less
	250.000 ~ 299.995	-3 or less	-3 or less
	300.000 ~ 500.000	-5 or less	-5 or less
FM Radio (12 dB S/N) (1 kHz/±52.5 kHz DEV)	76.000 ~ 108.000	0 or less	5 or less

- Selectivity:
 - AM/FM 50 dB or more
 - WFM 35 dB or more
- Audio output power (3.6 V):
 - External speaker 0.12 W or more (8 Ω load, at 10% distortion)
 - Internal speaker 0.4 W or more (8 Ω load, at 10% distortion)
- Power consumption
(3.6 V, FM, Single band display, Recording function OFF, Backlight OFF):
 - Receiving 380 mA typical
 - Standby 150 mA typical
 - Power saving 80 mA typical

◇ Bluetooth

- Version: Bluetooth Version 5.2
- Transmission Output: Class 1
- Profile: HFP Version 1.8
- The maximum number of paired Bluetooth devices: 1 device

MENU SCREEN ITEMS

When pushing [MENU], the following MENU items are displayed.
Refer to the Advanced manual for each menu item's details.

SIMPLE MODE
Favorite
Category/Group
(No Category)
Category name (Example: Airband)
Band
FM Radio
FM Radio Memory
Frequency
<<Scan>>
Favorite
Category/Group
Band
RECORD
<<REC Start>>
Play Files
Recorder Set
RX REC Condition
File Split
REC Operation
Player Set
Skip Time
FM RADIO
MEMORY
Memory CH
(No Category)
Category name (Example: Airband)
Auto MW CH
SKIP CH
<<Add Category>>
FM Radio Memory
A ~ Z

SET > Scan
Pause Timer
Resume Timer
Temporary Skip Timer
Program Skip
Program Scan Edge
Program Link
Auto MW SCAN Memory Clear
Group Link
DUP Check During MR Scan
SET > Function
Auto Power OFF
Power Save
Monitor
Dial Speed-UP
Key Lock
Frequency Selection Range
Memory Selection Range
CI-V
CI-V Address
CI-V Baud Rate (SP Jack)
CI-V Transceive
CI-V Echo Back (USB Jack)
CI-V USB→REMOTE Transceive Address
USB Connect
Heterodyne
Screen Capture [PWR] Key
Screen Capture File Type

SET > Display
Backlight
Backlight Timer
Brightness
Dim Screen
Dim Timer
Brightness (Dim)
RX Backlight (Except Radio)
Scroll Speed
Opening Message
Battery Level (Power ON)
Display Type
Display Language
System Language
SET > Sounds
Volume Select
Earphone Mode
Beep Level
Beep/Vol Level Link
Key-Touch Beep
Scan Stop Beep
Sub Band Mute
SET > Time Set
Date/Time
SET > SD Card
Load Setting
Save Setting
Import/Export
Import
Export
CSV Format
Opening Picture
SD Card Info
Screen Capture View
Firmware Update
Format
Unmount

SET > Bluetooth Set
Bluetooth
<<Pairing>>
Headset Set
AF Output
Auto Disconnect
Bluetooth Device Information
Initialize Bluetooth Device
SET > Others
Information
Battery
Version
Clone
Clone Mode
Reset
Partial Reset
All Reset

INDEX

1 MHz tuning 16

A

A band 13
Accessoriesvi
AM 15
AM-N 15
Attenuator 8
Attenuator (ATT) 17
Audio level 3
Auto Power OFF 8
Auto Power OFF icon 11

B

Band select 16
Battery icon 2
Battery pack
 Attaching 1
 Charging 2
B band 13
Bluetooth
 Deleting 29
 Disconnecting 29
 icon 8
 Pairing 28
 Turning ON 27

C

Charging 2
CLEAR key 7

D

Default setting 11
DIAL 7
DOC v
Dual band display 8, 13
Dualwatch 13

E

ENTER key 7

F

Favorites 35
 Add to Favorites 12
FCC v
FM 15
FM-N 15
FM Radio 36

L

Lock function 17
LOCK key 6

M

MAIN band 13
Memory channel
 Entering 20
 Selecting 18
Memory mode 15
MEMORY screen 18
MENU
 List 40
 MENU key 6
 MENU screen 10
 Operation 10
 Selecting a item 11
microSD card
 Formatting 4
 Inserting 3
 Removing 25
Monitor function 14
MR key 7
MW key 7, 20

P

Pairing 28
Partial Reset 31
Playing a recorded audio 25
Program Skip 22

Q

QUICK key 7
Quick Menu window 12

R

Receive band 16
Receive frequency 16
Receive mode 15
Recording
 Playing a recorded audio 25
 Starting recording 24
 Stopping recording 24
RECORDING key 7
Resetting 31

S

Save Setting	5
SCAN key	6
Scan starting or canceling	22
Screen Capture	7
Simple mode.....	34
Single band display	8, 13
SKIP key	6
S meter	9
Speaker jack.....	7
Specifications	38
Squelch.....	14
SQUELCH key.....	6
Sub Band Mute.....	13

T

Troubleshooting.....	32
Tuning step.....	16
Turning ON	3

U

UKCA DOC.....	v
USB port.....	7

V

VFO/MHz key	7
VFO mode	15
VOL	7

W

Weather Channel mode.....	15
---------------------------	----

ABOUT THE LICENSES

mbed TLS

Apache License

Version 2.0, January 2004

<http://www.apache.org/licenses/>

TERMS AND CONDITIONS FOR USE, REPRODUCTION, AND DISTRIBUTION

1. Definitions.

"License" shall mean the terms and conditions for use, reproduction, and distribution as defined by Sections 1 through 9 of this document.

"Licensor" shall mean the copyright owner or entity authorized by the copyright owner that is granting the License.

"Legal Entity" shall mean the union of the acting entity and all other entities that control, are controlled by, or are under common control with that entity. For the purposes of this definition, "control" means (i) the power, direct or indirect, to cause the direction or management of such entity, whether by contract or otherwise, or (ii) ownership of fifty percent (50%) or more of the outstanding shares, or (iii) beneficial ownership of such entity.

"You" (or "Your") shall mean an individual or Legal Entity exercising permissions granted by this License.

"Source" form shall mean the preferred form for making modifications, including but not limited to software source code, documentation source, and configuration files.

"Object" form shall mean any form resulting from mechanical transformation or translation of a Source form, including but not limited to compiled object code, generated documentation, and conversions to other media types.

"Work" shall mean the work of authorship, whether in Source or Object form, made available under the License, as indicated by a copyright notice that is included in or attached to the work (an example is provided in the Appendix below).

"Derivative Works" shall mean any work, whether in Source or Object form, that is based on (or derived from) the Work and for which the editorial revisions, annotations, elaborations, or other modifications represent, as a whole, an original work of authorship. For the purposes of this License, Derivative Works shall not include works that remain separable from, or merely link (or bind by name) to the interfaces of, the Work and Derivative Works thereof.

"Contribution" shall mean any work of authorship, including the original version of the Work and any modifications or additions to that Work or Derivative Works thereof, that is intentionally submitted to Licensor for inclusion in the Work by the copyright owner or by an individual or Legal Entity authorized to submit on behalf of the copyright owner. For the purposes of this definition, "submitted" means any form of electronic, verbal, or written communication sent to the Licensor or its representatives, including but not limited to communication on electronic mailing lists, source code control systems, and issue tracking systems that are managed by, or on behalf of, the Licensor for the purpose of discussing and improving the Work, but excluding communication that is conspicuously marked or otherwise designated in writing by the copyright owner as "Not a Contribution."

"Contributor" shall mean Licensor and any individual or Legal Entity on behalf of whom a Contribution has been received by Licensor and subsequently incorporated within the Work.

2. Grant of Copyright License. Subject to the terms and conditions of this License, each Contributor hereby grants to You a perpetual, worldwide, non-exclusive, no-charge, royalty-free, irrevocable copyright license to reproduce, prepare Derivative Works of, publicly display, publicly perform, sublicense, and distribute the Work and such Derivative Works in Source or Object form.
3. Grant of Patent License. Subject to the terms and conditions of this License, each Contributor hereby grants to You a perpetual, worldwide, non-exclusive, no-charge, royalty-free, irrevocable (except as stated in this section) patent license to make, have made, use, offer to sell, sell, import, and otherwise transfer the Work, where such license applies only to those patent claims licensable by such Contributor that are necessarily infringed by their Contribution(s) alone or by combination of their Contribution(s) with the Work to which such Contribution(s) was submitted. If You institute patent litigation against any entity (including a cross-claim or counterclaim in a lawsuit) alleging that the Work or a Contribution incorporated within the Work constitutes direct or contributory patent infringement, then any patent licenses granted to You under this License for that Work shall terminate as of the date such litigation is filed.
4. Redistribution. You may reproduce and distribute copies of the Work or Derivative Works thereof in any medium, with or without modifications, and in Source or Object form, provided that You meet the following conditions:
 - (a) You must give any other recipients of the Work or Derivative Works a copy of this License; and
 - (b) You must cause any modified files to carry prominent notices stating that You changed the files; and
 - (c) You must retain, in the Source form of any Derivative Works that You distribute, all copyright, patent, trademark, and attribution notices from the Source form of the Work, excluding those notices that do not pertain to any part of the Derivative Works; and

(d) If the Work includes a "NOTICE" text file as part of its distribution, then any Derivative Works that You distribute must include a readable copy of the attribution notices contained within such NOTICE file, excluding those notices that do not pertain to any part of the Derivative Works, in at least one of the following places: within a NOTICE text file distributed as part of the Derivative Works; within the Source form or documentation, if provided along with the Derivative Works; or, within a display generated by the Derivative Works, if and wherever such third-party notices normally appear. The contents of the NOTICE file are for informational purposes only and do not modify the License. You may add Your own attribution notices within Derivative Works that You distribute, alongside or as an addendum to the NOTICE text from the Work, provided that such additional attribution notices cannot be construed as modifying the License.

You may add Your own copyright statement to Your modifications and may provide additional or different license terms and conditions for use, reproduction, or distribution of Your modifications, or for any such Derivative Works as a whole, provided Your use, reproduction, and distribution of the Work otherwise complies with the conditions stated in this License.

5. **Submission of Contributions.** Unless You explicitly state otherwise, any Contribution intentionally submitted for inclusion in the Work by You to the Licensor shall be under the terms and conditions of this License, without any additional terms or conditions. Notwithstanding the above, nothing herein shall supersede or modify the terms of any separate license agreement you may have executed with Licensor regarding such Contributions.
6. **Trademarks.** This License does not grant permission to use the trade names, trademarks, service marks, or product names of the Licensor, except as required for reasonable and customary use in describing the origin of the Work and reproducing the content of the NOTICE file.
7. **Disclaimer of Warranty.** Unless required by applicable law or agreed to in writing, Licensor provides the Work (and each Contributor provides its Contributions) on an "AS IS" BASIS, WITHOUT WARRANTIES OR CONDITIONS OF ANY KIND, either express or implied, including, without limitation, any warranties or conditions of TITLE, NON-INFRINGEMENT, MERCHANTABILITY, or FITNESS FOR A PARTICULAR PURPOSE. You are solely responsible for determining the appropriateness of using or redistributing the Work and assume any risks associated with Your exercise of permissions under this License.
8. **Limitation of Liability.** In no event and under no legal theory, whether in tort (including negligence), contract, or otherwise, unless required by applicable law (such as deliberate and grossly negligent acts) or agreed to in writing, shall any Contributor be liable to You for damages, including any direct, indirect, special, incidental, or consequential damages of any character arising as a result of this License or out of the use or inability to use the Work (including but not limited to damages for loss of goodwill, work stoppage, computer failure or malfunction, or any and all other commercial damages or losses), even if such Contributor has been advised of the possibility of such damages.
9. **Accepting Warranty or Additional Liability.** While redistributing the Work or Derivative Works thereof, You may choose to offer, and charge a fee for, acceptance of support, warranty, indemnity, or other liability obligations and/or rights consistent with this License. However, in accepting such obligations, You may act only on Your own behalf and on Your sole responsibility, not on behalf of any other Contributor, and only if You agree to indemnify, defend, and hold each Contributor harmless for any liability incurred by, or claims asserted against, such Contributor by reason of your accepting any such warranty or additional liability.

END OF TERMS AND CONDITIONS

APPENDIX: How to apply the Apache License to your work.

To apply the Apache License to your work, attach the following boilerplate notice, with the fields enclosed by brackets "[]" replaced with your own identifying information. (Don't include the brackets!) The text should be enclosed in the appropriate comment syntax for the file format. We also recommend that a file or class name and description of purpose be included on the same "printed page" as the copyright notice for easier identification within third-party archives.

Copyright 2016, Arthur Teplitzki 2013, Edmodo, Inc.

Licensed under the Apache License, Version 2.0 (the "License");

you may not use this file except in compliance with the License.

You may obtain a copy of the License at

<http://www.apache.org/licenses/LICENSE-2.0>

Unless required by applicable law or agreed to in writing, software distributed under the License is distributed on an "AS IS" BASIS, WITHOUT WARRANTIES OR CONDITIONS OF ANY KIND, either express or implied.

See the License for the specific language governing permissions and limitations under the License.

