



**CI-V REFERENCE GUIDE**

---

COMMUNICATIONS RECEIVER  
**IC-R8600**

---

---

---

---

---

---

---

---

# Table of contents

REMOTE CONTROL .....	2
■ REMOTE CONTROL (CI-V) INFORMATION .....	2
◇ CI-V connection .....	2
◇ Preparation .....	2
◇ Data format .....	2
◇ Command table .....	3
◇ Command formats .....	9

# Remote control

## Remote control (CI-V) information

### ◆ CI-V connection

The receiver's operating frequency, mode, VFO and memory selection, can be remotely controlled using a PC.

- Use a USB cable (A-B (or A-miniB) type, user supplied) to connect the IC-R8600 and the PC (controller).

The required USB driver and driver installation guide can be downloaded from the Icom web site.

Go to "<http://www.icom.co.jp/world>," and then click "Support," "Firmware Updates / Software downloads" in sequence.

- ① The download procedure on the web page may be changed without notice.

### ◆ Preparing

The Icom Communications Interface V (CI-V) is used for remote control.

To control the receiver, first set its address, data communication speed, and transceive function.

These settings are set in Set mode (Refer to the IC-R8600 instruction manual).

### ◆ About the data format

The CI-V system can be written using the following data formats. Data formats differ according to command numbers. A data area or sub command is added for some commands.

### • Connection example

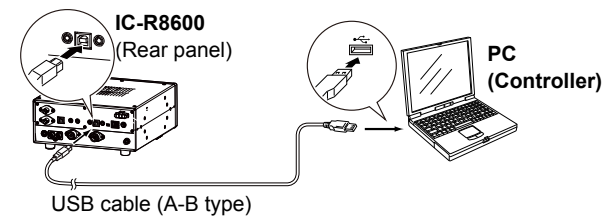
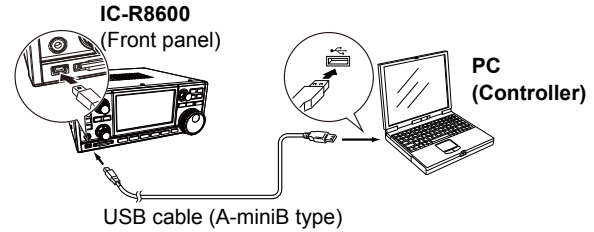

- ① Make the connection as short as possible. The receiver may not be recognized by the controller, depending on the USB cable length.

### Controller to IC-R8600

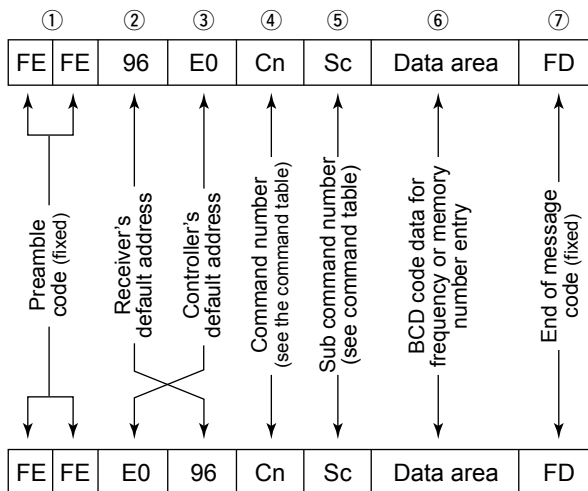

### IC-R8600 to controller

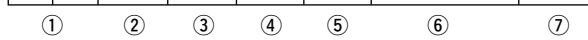

### OK message to controller

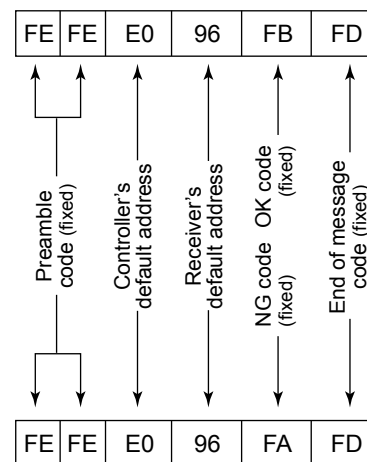

### NG message to controller

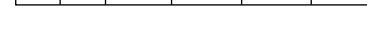

## Remote control

### ◆ Command table

Cmd.	Sub cmd.	Data	Description	
00		See p. 9	Output the frequency data for transceiver	
01		See p. 9	Output the receiving mode for transceiver	
02		See p. 9	Read the band edge frequencies	
03		See p. 9	Read the receiving frequency	
04		See p. 9	Read the receiving mode	
05		See p. 9	Set the receiving frequency	
06		See p. 9	Select the receiving mode	
07			Select the VFO mode	
08			Select the Memory mode	
		0000 ~ 0199	Select the Memory channel (0000 ~ 0099: Normal Memory channels/Scan Skip channels/Scan edges) (0000 ~ 0199: Auto Memory Write channels)	
	A0	0000 ~ 0102	Select the Memory group (0000 ~ 0099: Normal Memory channels 0100: Auto Memory Write channels 0101: Scan Skip channels 0102: Scan edges)	
09			Memory write	
0A			Memory copy to VFO	
0B			Memory clear	
0C			Read offset frequency	
0D		See p. 9	Set offset frequency	
0E	00		Scan stop	
	01		Programmed/memory scan start	
	02		Programmed scan start	
	03		$\Delta$ F scan start	
	04		Auto Memory Write scan start	
	12		Fine Programmed scan start	
	13		Fine $\Delta$ F scan start	
	22		Memory scan start	
	23		Select memory scan start	
	24		Mode Select scan start	
	42		Priority scan start	
	A0		Set the Fix of $\Delta$ F frequency to OFF	
	AA		Set the Fix of $\Delta$ F frequency to ON	
	Ax		Set/read the Fix range (x) of $\Delta$ F frequency (1= $\pm$ 5kHz, 2= $\pm$ 10kHz, 3= $\pm$ 20kHz, 4= $\pm$ 50kHz, 5= $\pm$ 100kHz, 6= $\pm$ 500kHz, 7= $\pm$ 1MHz)	
	B0		Set as non-select channel	
	B1			Set as select channel (If no selection is performed, the previously set number by CI-V is set after turning power ON, otherwise "1" is automatically set.)
			01 ~ 09	Set as select channel (01=SEL1, 02=SEL2, 03=SEL3, 04=SEL4, 05=SEL5, 06=SEL6, 07=SEL7, 08=SEL8, 09=SEL9)
	B2		00 ~ 09	Set starting select memory channel for a select memory scan (00=ALL, 01=SEL1, 02=SEL2, 03=SEL3, 04=SEL4, 05=SEL5, 06=SEL6, 07=SEL7, 08=SEL8, 09=SEL9)
	D0			Set Scan resume OFF
	D1			Set Scan resume ON (Close timer)
D3			Set Scan resume ON (Close & Delay)	
0F		10 ~ 12	Read duplex setting (10=OFF, 11=DUP-, 12=DUP+)	
	10		Set Simplex	
	11		Set Duplex -	
	12		Set Duplex +	
10*		00	Send/read the tuning step OFF(in 10 Hz steps)	
		01	Send/read the 100 Hz tuning step	
		02	Send/read the 1 kHz tuning step	
		03	Send/read the 2.5 kHz tuning step	
		04	Send/read the 3.125 kHz tuning step	
		05	Send/read the 5 kHz tuning step	
		06	Send/read the 6.25 kHz tuning step	
		07	Send/read the 8.33 kHz tuning step	
		08	Send/read the 9 kHz tuning step	
		09	Send/read the 10 kHz tuning step	
		10	Send/read the 12.5 kHz tuning step	
	11	Send/read the 20 kHz tuning step		

Cmd.	Sub cmd.	Data	Description
10*		12	Send/read the 25 kHz tuning step
		13	Send/read the 100 kHz tuning step
		14	Send/read the programmable tuning step
11*		00	Send/read Attenuator OFF (0 dB)
		10	Send/read Attenuator (10 dB)
		20	Send/read Attenuator (20 dB)
		30	Send/read Attenuator (30 dB)
12*		00 ~ 02	Select antenna (only 10 kHz – 29.999999 MHz) (00=ANT1, 01=ANT2, 02=ANT3)
13	00		Speech all parameters (Signal level + Frequency + Receiving mode)
	01		Speech frequency (Signal level + Frequency)
	02		Speech receiving mode ①The mode is announced after the ongoing speech.
14*	01	0000 ~ 0255	Send/read the AF gain level (0000=Minimum ~ 0255=Maximum)
	02	0000 ~ 0255	Send/read the RF gain level (0000=Minimum ~ 0255=Maximum)
	03	0000 ~ 0255	Send/read the squelch level (0000=Minimum ~ 0255=Maximum)
	06	0000 ~ 0255	Send/read the NR level (0000=0% ~ 0255=100%)
	07	0000 ~ 0255	Send/read the PBT1 position (0000=Narrow the upper edge, 0128=Center position, 0255=Narrow the lower edge)
	08	0000 ~ 0255	Send/read the PBT2 position (0000=Narrow the upper edge, 0128=Center position, 0255=Narrow the lower edge)
	09	0000 ~ 0255	Send/read CW pitch (0000=300 Hz, 0128=600 Hz, 0255=900 Hz) (in 5 Hz steps)
	0D	0000 ~ 0255	Send/read the NOTCH position (0000=A lower position, 0128=Center position, 0255=A upper position)
	12	0000 ~ 0255	Send/read the NB level (0000=0% ~ 0255=100%)
	19	0000 ~ 0255	Send/read the LCD brightness (0000=0% ~ 0255=100%)
	1B	0000 ~ 0255	Send/read the tone (Bass) level (0000=-15, 0128=0, 0255=+15)
	1C	0000 ~ 0255	Send/read the tone (Treble) level (0000=-15, 0128=0, 0255=+15)
	1D	0000 ~ 0255	Send/read the Scan Speed (0000=1, 0128=16, 0255=30)
	1E	0000 ~ 0255	Send/read the Scan Delay (0000=1s, 0128=16s, 0255=30s)
	1F	0000 ~ 0255	Send/read the PRIO Interval (0000=1s, 0128=8s, 0255=15s)
	15	01	00/01
02		0000 ~ 0255	Read the S-meter level (0000=S0, 0120=S9, 0241=S9+60dB)
03			Read the meter level in the "AAAABBCC" Format: AAAA= Absolute signal strength (in 0.1 steps) BB= Plus or minus sign (0/1=+/-) CC= Meter type (0/1/2=dB $\mu$ /dB $\mu$ EMF/dBm)
04		0000 ~ 0255	Read the center meter level (0000= Left edge, 0128= Center, 0255= Right edge)
16*	05	00/01	Read various squelch function's (including the tone squelch) status (00=Close, 01=Open)
	17	00/01	Read the S-AM SYNC Indicator (00=Non-synchronous, 01=Synchronous)
	18	00/01	Read the OVF indicator status (00=OFF, 01=ON)
16*	02	00/01	Send/read the Preamp status (00=OFF, 01=ON)
	12	01 ~ 03	Send/read the AGC function status (01=FAST, 02=MID, 03=SLOW)

## Remote control

### ◇ Command table (Continued)

Cmd.	Sub cmd.	Data	Description	
16*	22	00/01	Send/read the Noise blanker function status (00=OFF, 01=ON)	
	40	00/01	Send/read the Noise reduction function status (00=OFF, 01=ON)	
	41	00/01	Send/read the Auto notch function status (00=OFF, 01=ON)	
	43	00/01	Send/read the Tone squelch status (00=OFF, 01=ON)	
	48	00/01	Send/read the Manual notch function status (00=OFF, 01=ON)	
	4A	00/01	Send/read the AFC function status (00=OFF, 01=ON)	
	4B	00/01	Send/read the DTCS function status (00=OFF, 01=ON)	
	4C	00/01	Send/read the VSC function status (00=OFF, 01=ON)	
	4F	00/01	Send/read the Twin Peak Filter status (00=OFF, 01=ON)	
	50	00/01	Send/read the Dial lock function status (00=OFF, 01=ON)	
	52	00/01	Send/read the P25 digital squelch (D.SQL) setting (00=OFF, 01=NAC)	
	56	00/01	Send/read the DSP filter type (00=SHARP, 01=SOFT)	
	57	00 ~ 02	Send/read the Manual notch width (00=WIDE, 01=MID, 02=NAR)	
	5B	00/02	Send/read the D-STAR digital squelch (D.SQL) setting (00=OFF, 02=CSQL)	
	5F	00/01	Send/read the dPMR digital squelch (D.SQL) setting (00=OFF, 01=COM ID, 02=CC)	
	60	00/01	Send/read the NXDN digital squelch (D.SQL) setting (00=OFF, 01=RAN)	
	61	00/01	Send/read the DCR digital squelch (D.SQL) setting (00=OFF, 01=UC)	
	62	00/01	Send/read the dPMR SCRAMBLER function status (00=OFF, 01=ON)	
	63	00/01	Send/read the NXDN ENCRYPTION function status (00=OFF, 01=ON)	
	64	00/01	Send/read the DCR ENCRYPTION function status (00=OFF, 01=ON)	
18	00		Turn OFF the receiver	
	01		Turn ON the receiver*1	
19	00		Read the receiver ID	
1A	00*	See pp. 11 ~ 14	Send/read memory channel contents	
	03*	00 ~ 49	Send/read the selected filter width (AM mode: 00=200 Hz ~ 49=10 kHz, other than AM mode: 00=50 Hz ~ 40/31=3600/2700 Hz)	
	04*	00 ~ 13	Send/read the selected AGC time constant (00=OFF, SSB/CW/FSK modes: 01=0.1 ~ 13=6.0 seconds AM mode: 01=0.3 ~ 13=8.0 seconds)	
	05*	0001	See p. 10	Send/read the FM audio tone (HPF/LPF) settings
		0002	00 ~ 30	Send/read the FM audio tone (Bass) settings (00=-15 ~ 30=+15)
		0003	00 ~ 30	Send/read the FM audio tone (treble) settings (00=-15 ~ 30=+15)
		0004	00/01	Send/read the de-emphasis (50k) (00=OFF, 01=ON)
0005	00/01	Send/read the de-emphasis (15k) (00=OFF, 01=ON)		
0006	00/01	Send/read the de-emphasis (7k) (00=OFF, 01=ON)		

Cmd.	Sub cmd.	Data	Description	
1A	05*	0007	00 ~ 30	Send/read the WFM audio tone (Bass) settings (00=-15 ~ 30=+15)
		0008	00 ~ 30	Send/read the WFM audio tone (Treble) settings (00=-15 ~ 30=+15)
		0009	See p. 10	Send/read the AM audio tone (HPF/LPF) settings
		0010	00 ~ 30	Send/read the AM audio tone (Bass) settings (00=-15 ~ 30=+15)
		0011	00 ~ 30	Send/read the AM audio tone (Treble) settings (00=-15 ~ 30=+15)
		0012	See p. 10	Send/read the SSB audio tone (HPF/LPF) settings
		0013	00 ~ 30	Send/read the SSB audio tone (Bass) settings (00=-15 ~ 30=+15)
		0014	00 ~ 30	Send/read the SSB audio tone (Treble) settings (00=-15 ~ 30=+15)
		0015	See p. 10	Send/read the CW audio tone (HPF/LPF) settings
		0016	00 ~ 30	Send/read the CW audio tone (Bass) settings (00=-15 ~ 30=+15)
		0017	00 ~ 30	Send/read the CW audio tone (Treble) settings (00=-15 ~ 30=+15)
		0018	See p. 10	Send/read the FSK audio tone (HPF/LPF) settings
		0019	00 ~ 30	Send/read the FSK audio tone (Bass) settings (00=-15 ~ 30=+15)
		0020	00 ~ 30	Send/read the FSK audio tone (Treble) settings (00=-15 ~ 30=+15)
		0021	See p. 10	Send/read the D-STAR audio tone (HPF/LPF) settings
		0022	00 ~ 30	Send/read the D-STAR audio tone (Bass) settings (00=-15 ~ 30=+15)
		0023	00 ~ 30	Send/read the D-STAR audio tone (Treble) settings (00=-15 ~ 30=+15)
		0024	See p. 10	Send/read the P25 audio tone (HPF/LPF) settings
		0025	00 ~ 30	Send/read the P25 audio tone (Bass) settings (00=-15 ~ 30=+15)
		0026	00 ~ 30	Send/read the P25 audio tone (Treble) settings (00=-15 ~ 30=+15)
		0027	See p. 10	Send/read the dPMR audio tone (HPF/LPF) settings
		0028	00 ~ 30	Send/read the dPMR audio tone (Bass) settings (00=-15 ~ 30=+15)
		0029	00 ~ 30	Send/read the dPMR audio tone (Treble) settings (00=-15 ~ 30=+15)
		0030	See p. 10	Send/read the NXDN audio tone (HPF/LPF) settings
		0031	00 ~ 30	Send/read the NXDN audio tone (Bass) settings (00=-15 ~ 30=+15)
		0032	00 ~ 30	Send/read the NXDN audio tone (Treble) settings (00=-15 ~ 30=+15)
		0033	See p. 10	Send/read the DCR audio tone (HPF/LPF) settings
		0034	00 ~ 30	Send/read the DCR audio tone (Bass) settings (00=-15 ~ 30=+15)
		0035	00 ~ 30	Send/read the DCR audio tone (Treble) settings (00=-15 ~ 30=+15)
		0036	0000 ~ 0255	Send/read the beep level (0000=0% ~ 0255=100%)
		0037	00/01	Send/read beep gain limit (00=OFF, 01=ON)

## Remote control

### ◇ Command table (Continued)

Cmd.	Sub cmd.	Data	Description
1A	05*	0038	00/01 Send/read confirmation beep (00=OFF, 01=ON)
		0039	00/01 Send/read speech language (00=English, 01=Japanese)
		0040	00/01 Send/read speech speed (00=Slow, 01=Fast)
		0041	00/01 Send/read S-meter level speech (00=OFF, 01=ON)
		0042	00/01 Send/read receiving mode speech (00=OFF, 01=ON)
		0043	00/01 Send/read scan speech function (00=OFF, 01=ON)
		0044	00 ~ 02 Send/read the setting of the speech output from the external terminals (00=OFF, 01=Push/Touch, 02=ALL)
		0045	00 ~ 02 Send/read the speech recording setting (00=OFF, 01=Push/Touch, 02=ALL)
		0046	0000 ~ 0255 Send/read the speech level (0000=0% ~ 0255=100%)
		0047	00/01 Send/read the [SPEECH/LOCK] key action (00=Push: SPEECH, Hold down: LOCK, 01=Push: LOCK, Hold down: SPEECH)
		0048	00/01 Send/read the [P.LOCK] key action (00=ALL, 01=KEY)
		0049	00 ~ 02 Send/read the Automatic TS function (00=OFF, 01=LOW, 02=HIGH)
		0050	00/01 Send/read the AFC limit (00=OFF, 01=ON)
		0051	00 ~ 02 Send/read the [NOTCH] key action in the AM mode (00=Auto, 01=Manual, 02=Auto/Manual)
		0052	00 ~ 02 Send/read the [NOTCH] key action in the SSB mode (00=Auto, 01=Manual, 02=Auto/Manual)
		0053	00/01 Send/read SSB/CW synchronous tuning (00=OFF, 01=ON)
		0054	00/01 Send/read the CW normal side setting (00=LSB, 01=USB)
		0055	00/01 Assign the Screen Capture function to [POWER] (00=OFF, 01=ON)
		0056	00/01 Send/read the file format for the Screen Capture function (00=PNG, 01=BMP)
		0057	00/01 Send/read the Keyboard type (00=Ten-key, 01=Full Keyboard)
		0058	0000 ~ 0511 Send/read the reference frequency adjustment value (0000=0% ~ 0511=100%)
		0059	00 ~ 02 Send/read the receive mode when [DIAL B] is pushed in the DIGITAL mode (00=Auto, 01=Digital, 02=Analog)
		0060	00/01 Send/read the RX history log function (00=OFF, 01=ON)
		0061	00 ~ 02 Send/read the separator for the CSV file (00=Separator ",", Decimal point ".", 01=Separator ";", Decimal point ".", 02=Separator ";", Decimal point ",")
		0062	00 ~ 02 Send/read the date format of the CSV file (00=yyyy/mm/dd, 01=mm/dd/yyyy, 02=dd/mm/yyyy)
		0063	00/01 Send/read the D-STAR standby beep (00=OFF, 01=ON)
		0064	00/01 Send/read the DV (D-STAR) mode Automatic Detect function (00=OFF, 01=ON)
		0065	00/01 Send/read the call history of received DV (D-STAR) signal from a repeater (00=ALL, 01=Latest Only)
		0066	0000 ~ 0255 Send/read the EMR signal audio output level (0000=0% ~ 0255=100%)
		0067	0040 ~ 0200 Send/read the output ratio of the speaker output level and headphones output level (0040=0.40 ~ 0200=2.00)
		0068	00/01 Send/read the signal output from [AF/IF] (00=AF, 01=IF)
		0069	0000 ~ 0255 Send/read the AF output level of [AF/IF] (0000=0% ~ 0255=100%)

Cmd.	Sub cmd.	Data	Description
1A	05*	0070	00/01 Send/read the audio output setting for [AF/IF] (00=OFF (OPEN): The squelch is always opened. 01=ON: The squelch opens and closes, according to the squelch and signal levels.)
		0071	00/01 Send/read the Beep and Speech audio output status of [AF/IF] (00=OFF, 01=ON)
		0072	0000 ~ 0255 Send/read the IF output level of [AF/IF] (0000=0% ~ 0255=100%)
		0073	00/01 Send/read the signal output from [USB] on the front panel (00=AF, 01=IF)
		0074	0000 ~ 0255 Send/read the AF output level of [USB] on the front panel (0000=0% ~ 0255=100%)
		0075	00/01 Send/read the audio output setting for [USB] on the front panel (00=OFF (OPEN): The squelch is always opened. 01=ON: The squelch opens and closes, according to the squelch and signal levels.)
		0076	00/01 Send/read the Beep and Speech audio output status of [USB] on the front panel (00=OFF, 01=ON)
		0077	0000 ~ 0255 Send/read the IF output level of [USB] on the front panel (0000=0% ~ 0255=100%)
		0078	00/01 Send/read the signal output from [USB] on the front panel (00=An FSK decoded signal, 01=A D-STAR data)
		0079	00 ~ 03 Send/read the data transfer rate (Baud rate) of decoded FSK signals from [USB] on the front panel (00=4800 bps, 01=9600 bps, 02=19200 bps, 03=38400 bps)
		0080	00/01 Send/read the data transfer rate (Baud rate) of decoded D-STAR data from [USB] on the front panel (00=4800 bps, 01=9600 bps)
		0081	00/01 Send/read the signal output from [USB] on the rear panel (00=AF, 01=IF)
		0082	0000 ~ 0255 Send/read the AF output level of [USB] on the rear panel (0000=0% ~ 0255=100%)
		0083	00/01 Send/read the audio output setting for [USB] on the rear panel (00=OFF (OPEN): The squelch is always opened. 01=ON: The squelch opens and closes, according to the squelch and signal levels.)
		0084	00/01 Send/read the Beep and Speech audio output status of [USB] on the rear panel (00=OFF, 01=ON)
		0085	0000 ~ 0255 Send/read the IF output level of [USB] on the rear panel (0000=0% ~ 0255=100%)
		0086	00/01 Send/read the signal output from [USB] on the rear panel. (00=An FSK decoded signal, 01=A D-STAR data)
		0087	00 ~ 03 Send/read the data transfer rate (Baud rate) of decoded FSK signals from [USB] on the rear panel (00=4800 bps, 01=9600 bps, 02=19200 bps, 03=38400 bps)
		0088	00/01 Send/read the data transfer rate (Baud rate) of decoded D-STAR data from [USB] on the rear panel (00=4800 bps, 01=9600 bps)
		0089	00/01 Send/read the signal output from [LAN]. (00=AF, 01=IF)
		0090	00/01 Send/read the audio output setting for [LAN] (00=OFF (OPEN): The squelch is always opened. 01=ON: The squelch opens and closes, according to the squelch and signal levels.)

## Remote control

### ◇ Command table (Continued)

Cmd.	Sub cmd.	Data	Description
1A	05*	0091	00/01 Send/read the Speech audio output status of [LAN] (00=OFF, 01=ON)
		0092	00/01 Send/read the CI-V transceive function setting (00=OFF, 01=ON)
		0093	0000 ~ 0223 Send/read the CI-V transceive address (USB/LAN → REMOTE) setting (in Hexadecimal) (0000=00h ~ 0223=DFh)
		0094	00/01 Send/read the Data Echo Back function for the [USB] (Front) CI-V port (00=OFF, 01=ON)
		0095	00/01 Read the CI-V USB (Rear) port setting (00=Connect to [REMOTE], 01=Disconnect from [REMOTE]) (Read only)
		0096	00/01 Send/read the Data Echo Back function for the [USB] (Rear) CI-V port (00=OFF, 01=ON)
		0097	00/01 Send/read the signal output from [METER] (00=Signal strength, 01=Signal strength and squelch level)
		0098	0000 ~ 0255 Send/read the voltage level output from [METER] (0000=0% ~ 0255=100%)
		0099	00 ~ 02 Send/read the receiver's reference frequency signal source (00=IN Uses an external reference signal, 01=OFF, 02=Outputs the internal reference signal.)
		0100	00/01 Send/read the DHCP function (00=OFF, 01=ON)
		0101	Set the static IP address (0000000000000001 ~ 0255025502550254)
		0102	Read the dynamic IP address (0000000000000001 ~ 0255025502550254) (The automatically obtained address (if the DHCP is set to ON), or a manually set static IP address.)
		0103	01 ~ 30 Send/read the subnet mask to connect to your PC or LAN (01=1 bit ~ 30=30 bit)
		0104	Send/read the default gateway setting (0000 0000 0000 0001 ~ 0255 0255 0255 0254, FF (blank))
		0105	Send/read the primary DNS server address (0000 0000 0000 0001 ~ 0255 0255 0255 0254, FF(blank))
		0106	Send/read the secondary DNS server address (0000 0000 0000 0001 ~ 0255 0255 0255 0254, FF(blank))
		0107	See p. 10 Send/read the network name (Up to 15 characters)
		0108	00/01 Send/read the network control setting. (00=OFF, 01=ON)
		0109	00/01 Send/read the Power OFF Setting (for Remote Control) (00=Shutdown only, 01=Standby/Shutdown)
		0110	000001 ~ 065535 Send/read the UDP port number for the control signal transfer (1 ~ 65535)
		0111	000001 ~ 065535 Send/read the UDP port number for the serial data transfer (1 ~ 65535)
		0112	000001 ~ 065535 Send/read the UDP port number for the audio signal transfer (1 ~ 65535)
		0113	00/01 Send/read the internet access line (00=FTTH, 01=ADSL/CATV)
		0114	See p. 10 Send/read the nickname of the IC-R8600 (1 ~ 16 characters)
		0115	0000 ~ 0255 Send/read the LCD backlight brightness (0000=0% ~ 0255=100%)
		0116	0000 ~ 0255 Send/read the LED brightness (0000=0% ~ 0255=100%)
		0117	00/01 Send/read the display background type (00=A, 01=B)
		0118	00/01 Send/read the Meter Peak Hold function (00=OFF, 01=ON)
		0119	00/01 Send/read the Memory name display (00=OFF, 01=ON)

Cmd.	Sub cmd.	Data	Description
1A	05*	0120	00/01 Send/read the group name display function (00=OFF, 01=ON The group name is displayed when you change the memory channel group)
		0121	00/01 Send/read the Notch filter width display function (00=OFF, 01=ON The filter width is displayed when you select the Manual Notch.)
		0122	00/01 Send/read the digital TWIN PBT shift value display function (00=OFF, 01=ON The shift value is displayed while rotating [DIAL C].)
		0123	00/01 Send/read the digital IF filter width and shift value display function (00=OFF, 01=ON The filter width and shift value are displayed when you change the IF filter.)
		0124	00 ~ 03 Send/read the digital signal information display function (00=OFF, 01=Normal, 02=RX Hold, 03=Hold)
		0125	00/01 Send/read the P25 ID display type (00=Decimal, 01=Hexadecimal)
		0126	00 ~ 03 Send/read the Screen Saver activation time (00=OFF, 01=15 minutes, 02=30 minutes, 03=60 minutes)
		0127	00/01 Send/read the opening message display function (00=OFF, 01=ON)
		0128	p.10 Send/read the opening comment (Up to 10 characters)
		0129	00/01 Send/read the display language (00=English, 01=Japanese)
		0130	00/01 Send/read the system language (00=English, 01=Japanese)
		0131	20000101 ~ 20991231 Send/read the date (Year/Month/Day) (20000101 "2000/1/1" ~ 20991231 "2099/12/31")
		0132	0000 ~ 2359 Send/read the current time (0000 "00:00" ~ 2359 "23:59")
		0133	00/01 Send/read the NTP function (00=OFF, 01=ON)
		0134	See p. 10 Send/read the NTP server address (Up to 64 characters)
		0135	See p. 10 Send/read the UTC offset time (-14:00 ~ +14:00 (in 5 minutes steps))
		0136	00 ~ 02 Send/read the scope peak level holding function (00=OFF, 01=10 seconds Hold, 02=ON)
		0137	00 ~ 02 Send/read the scope center position (00=Filter Center, 01=Carrier Point Center, 02=Carrier Point Center (with absolute frequency)) (Only in the Center mode)
		0138	00/01 Send/read the scope marker position (00=Filter Center, 01=Carrier Point) (Only in the Fixed mode)
		0139	00/01 Send/read the scope Video Band Width (VBW) (00=Narrow, 01=Wide)
		0140	00 ~ 03 Send/read the FFT scope waveform averaging function (00=OFF, 01=2, 02=3, 03=4)
		0141	00/01 Send/read the scope outline waveform display (00=Fill, 01=Fill+Line)
		0142	See p. 10 Send/read the scope waveform (current) color
		0143	See p. 10 Send/read the waveform outline color
		0144	See p. 10 Send/read the scope waveform (Max hold) color
0145	See p. 10 Send/read the pointer color for the RX Marker		

## Remote control

### ◇ Command table (Continued)

Cmd.	Sub cmd.	Data	Description
1A	05*	0146	See p. 10 Send/read the pointer color for the Peak Marker
		0147	00/01 Send/read the scope Water fall display (00=OFF, 01=ON)
		0148	00 ~ 02 Send/read the scope Waterfall speed (00=Slow, 01=Mid, 02=Fast)
		0149	00 ~ 02 Send/read the scope Waterfall height for the Expand scope screen (00=Small, 01=Mid, 02=Large)
		0150	00 ~ 07 Send/read the signal level that the scope Waterfall displays a peak color (00=Grid 1, 01=Grid 2, 02=Grid 3, 03=Grid 4, 04=Grid 5, 05=Grid 6, 06=Grid 7, 07=Grid 8)
		0151	00/01 Send/read the Waterfall Marker Auto-hide function setting (00=OFF, 01=ON)
		0152	00 ~ 60 Send/read the difference of amplitude between the peak signal and nearby signals (00=0 dB ~ 60=60 dB)
		0153	00 ~ 80 Send/read the threshold level for the Peak signal detection (00=-80 dB ~ 80=0 dB)
		0154	00/01 Send/read the spectrum waveform peek search type (00=Real time, 01=Max. Hold)
		0155	00 ~ 02 Send/read the period of time of the Temporary Skip timer (00=5 minutes, 01=10 minutes, 02=15 minutes)
		0156	00/01 Send/read the Skip function setting (00=OFF, 01=ON)
		0157	00 ~ 02 Send/read the Auto Memory Write Scan starting option (00=OFF, 01=Displays the dialog, 02=ON)
		0158	00/01 Send/read the SCAN screen display option (00=OFF, 01=ON)
		0159	00/01 Send/read the scan operation when MAIN DIAL is rotated (00=OFF, 01=Up/Down)
		0160	00 ~ 03 Send/read the FSK FFT scope waveform averaging function setting (00=OFF, 01=2, 02=3, 03=4)
		0161	See p. 10 Send/read the color of the FSK FFT scope waveform (000000000000 ~ 025502550255)
		0162	00/01 Send/read the FSK Letter Code Decoding function setting (00=OFF, 01=ON)
		0163	00/01 Send/read the FSK decoder new line code (00=CR,LF,CR+LF, 01=CR+LF)
		0164	00/01 Send/read the FSK log time stamp (Time) (00=Local, 01=UTC)
		0165	00/01 Send/read the FSK log time stamp (Frequency) (00=OFF, 01=ON)
		0166	See p. 10 Send/read the text font color for received FSK signal
		0167	See p. 10 Send/read the text font color for the time stamp
		0168	00/01 Send/read FSK log function setting (00=OFF, 01=ON)
		0169	00/01 Send/read FSK log file type (00=Text, 01=HTML)
		0170	00/01 Send/read the FSK RX frequency (00=Mark (Space), 01=Mark/Space center)
		0171	00 ~ 03 Send/read the FSK mark frequency (00=1275, 01=1500, 02=1615, 03=2125)
		0172	00 ~ 04 Send/read the FSK shift width (00=170, 01=200, 02=425, 03=800, 04=850)
		0173	00/01 Send/read the recording setting (00=Always, 01=Squelch Auto)
		0174	00/01 Send/read the File Split function setting (00=OFF, 01=ON)
		0175	00 ~ 03 Send/read the player skip time (00=3 seconds, 01=5 seconds, 02=10 seconds, 03=30 seconds)

Cmd.	Sub cmd.	Data	Description	
1A	05*	0176	00 ~ 09 Send/read the Noise Blanker depth (Noise reducing level) (00=1 ~ 09=10)	
		0177	0000 ~ 0255 Send/read the Noise Blanker width (Blanking period) (0000=1 ~ 0255=100)	
		0178	00/01 Send/read the Memory group type (00=Current group, 01=All groups)	
		0179	00/01 Send/read the scanning Memory group type (00=Current group, 01=All groups)	
		0180	00 ~ 03 Send/read the meter type (00=S, 01=dBμ, 02=dBμ EMF, 03=dBm)	
		07*	00/01 Send/read the IP+ function (00=OFF, 01=ON)	
		08	 Read the power supply voltage (You can remotely check the power supply voltage in 0.1 V steps.)	
		09*	00/01 Send/read the connection status of NTP server (00=Stop, 01=Start)	
		0A	00 ~ 02 Read the date and time update result (00=Updating, 01=Succeed, 02=Failed)	
		1B*	01	See p. 14 Send/read the TSQL tone frequency
			02	See p. 14 Send/read the DTCS code
			03	000 ~ FFF Send/read the P25 NAC (First 4 bits in each byte are fixed to "0.")
			07	00 ~ 99 Send/read the D-STAR CSQcode
08	001 ~ 255 Send/read the dPMR COM ID			
09	00 ~ 63 Send/read the dPMR CC			
0A	00 ~ 63 Send/read the NXDN RAN			
0B	001 ~ 511 Send/read the DCR UC			
0C	00001 ~ 32767 Send/read the dPMR scrambler key			
0D	00001 ~ 32767 Send/read the NXDN encryption key			
0E	00001 ~ 32767 Send/read the DCR encryption key			
1C*	02	00/01 Send/read the Monitor function (00=OFF, 01=ON)		
1D*		00/02 Send/read the REMOTE function setting (00=OFF, 02=ON)		
20	00	00*	00/01 Send/read the D-STAR Call sign output setting (00=Transceive OFF, 01=Transceive ON)	
		01	See p. 15 Output the D-STAR Call sign setting for transceive	
		02	See p. 15 Read the D-STAR Call sign contained in the received signal	
	01	00*	00/01 Send/read the D-STAR message output setting (00=Transceive OFF, 01=Transceive ON)	
		01	See p. 15 Output the D-STAR message for transceive	
	02	00*	00/01 Send/read the D-STAR RX status output setting (00=Transceive OFF, 01=Transceive ON)	
		01	See p. 15 Output the D-STAR RX status for transceive	
	03	00*	00/01 Send/read the D-STAR RX GPS/D-PRS data output setting (00=Transceive OFF, 01=Transceive ON)	
		01	See pp. 16 ~ 17 Output the D-STAR RX GPS/D-PRS data for transceive	
	04	00*	00/01 Send/read the D-STAR RX GPS/D-PRS message output setting (00=Transceive OFF, 01=Transceive ON)	
		01	See p. 17 Output the D-STAR RX GPS/D-PRS message for transceive	
	05	00*	00/01 Send/read the D-STAR RX CSQ code output setting (00=Transceive OFF, 01=Transceive ON)	
		01	See p. 18 Output the D-STAR RX CSQ code for transceive	
	06	00*	00/01 Send/read the P25 ID output setting (00=Transceive OFF, 01=Transceive ON)	
		01	See p. 18 Output the P25 ID for transceive	
		02	See p. 18 Read the P25 ID	



## Remote control

### ◇ Command table (Continued)

Cmd.	Sub cmd.	Data	Description
20	07	00*	Send/read the P25 RX status output setting (00=Transceive OFF, 01=Transceive ON)
		01	See p. 18 Output the P25 RX status for transceive
		02	See p. 18 Read the P25 RX status
	08	00*	Send/read the dPMR RX ID output setting (00=Transceive OFF, 01=Transceive ON)
		01	See p. 18 Output the dPMR RX ID for transceive
		02	See p. 18 Read the dPMR RX ID
	09	00*	Send/read the dPMR RX status output setting (00=Transceive OFF, 01=Transceive ON)
		01	See p. 19 Output the dPMR RX status for transceive
		02	See p. 19 Read the dPMR RX status
	0A	00*	Send/read the NXDN RX ID output setting (00=Transceive OFF, 01=Transceive ON)
		01	See p. 19 Output the NXDN RX ID for transceive
		02	See p. 19 Read the NXDN RX ID
0B	00*	Send/read the NXDN RX status output setting (00=Transceive OFF, 01=Transceive ON)	
	01	See p. 19 Output the NXDN RX status for transceive	
	02	See p. 19 Read the NXDN RX status	
0C	00*	Send/read the DCR RX ID output setting (00=Transceive OFF, 01=Transceive ON)	
	01	See p. 20 Output the DCR RX ID for transceive	
	02	See p. 20 Read the DCR RX ID	
0D	00*	Send/read the DCR RX status output setting (00=Transceive OFF, 01=Transceive ON)	
	01	See p. 20 Output the DCR RX status for transceive	
	02	See p. 20 Read the DCR RX status	
22	01	00*	Send/read the D-STAR RX data output setting (00=Transceive OFF, 01=Transceive ON)
		01	See p. 20 Output the D-STAR RX data for transceive
25*		See p. 20	Send/read the selected or not selected VFO frequency
26*		See p. 21	Send/read the selected or not selected VFO's operating mode and filter
27*	00	See p. 21	Read the Scope waveform data
	10	00/01	Send/read the Scope ON/OFF status (00=OFF, 01=ON)
	11* <sup>2</sup>	00/01	Send/read the Scope wave data output setting (00=OFF, 01=ON)
	12	00	Send/read the Scope MAIN/SUB setting (00=Fixed to MAIN)
	13	00	Send/read the Scope Single/Dual setting (00=Fixed to Single)
	14	See p. 22	Send/read the Scope Center mode or Fixed mode setting
	15	See p. 22	Send/read the span setting in the Center mode Scope
	17	See p. 22	Send/read the Scope hold function status
	19	See p. 22	Send/read the Scope Reference level
	1A	See p. 22	Send/read the Sweep speed
	1C	00 ~ 02	Send/read scope center frequency setting in the Center mode (00=Filter Center, 01=Carrier Point Center, 02=Carrier Point Center (Abs. Freq.))
1D	See p. 22	Send/read the Scope VBW setting	
1E	See p. 22	Send/read the Scope Fixed edge frequencies	

\*(Asterisk) Send/read data

\*<sup>1</sup> When sending the power ON command (18 01), you need to repeatedly send "FE" before the standard format. The following is the approximate number of needed repetition.

- 115200 bps: 119 "FE"s
- 57600 bps: 59 "FE"s
- 38400 bps: 40 "FE"s
- 19200 bps: 20 "FE"s
- 9600 bps: 9 "FE"s
- 4800 bps: 5 "FE"s

Example: When using 4800 bps

		Preamble		R8600's address	Controller's address	Command	Sub command	Postamble					
F	E	F	E	9	6	E	0	1	8	0	1	F	D

×5

\*<sup>2</sup> When you use the [USB (Front)] port, you need to select "115200" in the "CI-V Baud Rate" item. When you use the [USB (Rear)] port, you need to select "Unlink from [REMOTE]" in the "CI-V USB port" item, and need to select "115200" in the "CI-V Baud Rate" item. You can use the [LAN] port regardless of those settings. You cannot use the [REMOTE] terminal regardless of those settings.

# Remote control

## ◆ Command formats

### ● Receiving frequency

Command: **00, 03, 05**

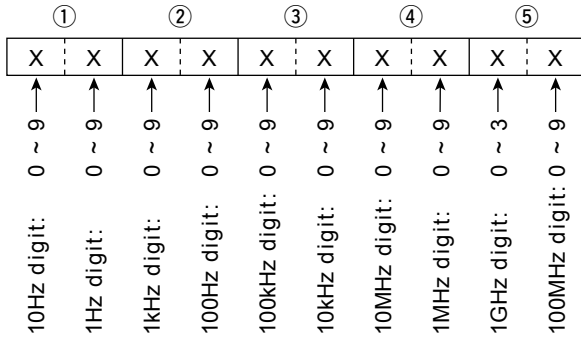

### ● Offset frequency

Command: **0D**

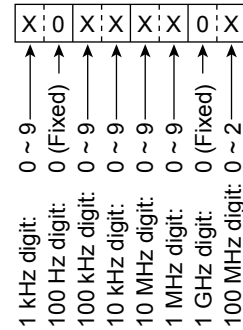

### ● Receiving mode

Command: **01, 04, 06**

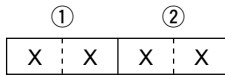

① Receiving mode		② Filter setting
00:LSB	11:S-AM (D)	01:FIL1
01:USB	14:S-AM (L)	02:FIL2
02:AM	15:S-AM (U)	03:FIL3
03:CW	16:P25	—
04:FSK	17:D-STAR	—
05:FM	18:dPMR	—
06:WFM	19:NXDN-VN	—
07:CW-R	20:NXDN-N	—
08:FSK-R	21:DCR	—

①Filter setting (②) can be skipped with command 01 and 06. In that case, "FIL1" is selected with command 01 and the default filter setting of the receiving mode is automatically selected with command 06.

### ● Band edge frequency

Command: **02**

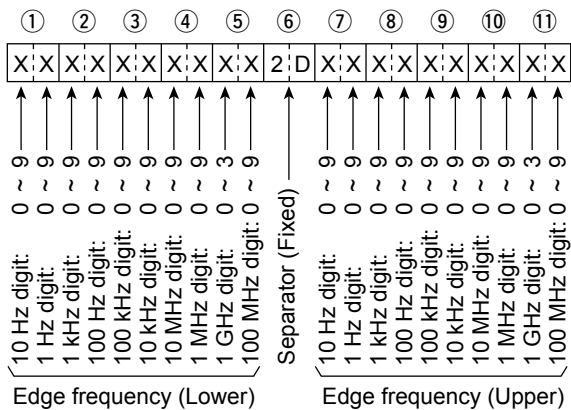

# Remote control

## ◇ Command formats (Continued)

### ● RX HPF/LPF setting for each operating mode

Command: **1A 05 0001, 0009, 0012, 0015, 0018, 0021, 0024, 0027, 0030, 0033**



#### LPF

05 ~ 24=500 ~ 2400 Hz

25 =Through

#### HPF

00 =Through

01 ~ 20=100 ~ 2000 Hz

(The HPF value must be lower than LPF.)

### ● UTC Offset setting

Command: **1A 05 0135**

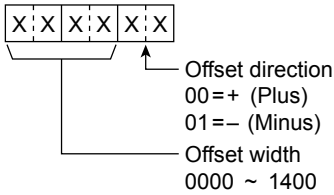

### ● Scope/FSK FFT Scope waveform/FSK font color

Command: **1A 05 0142 ~ 0146,**

**0161, 0166, 0167**

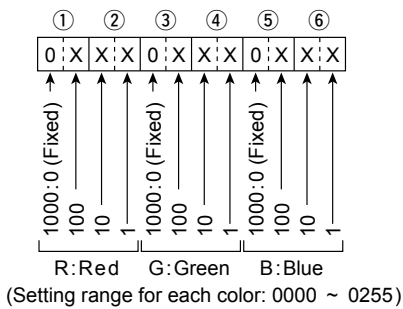

### ● Character entries

Command: **1A 00,**

**1A 05 0107, 0114, 0128, 0134**

Command	Edit items	Total character number
	Selectable characters	
1A 00	MEMORY NAME	16
	A to Z, a to z, 0 to 9, (space), @ % & # + - = [ ] / ( ) ; : ^ ! ? < > . , " \$ ' * _ ` { } ~ \	
1A 05 0107	NETWORK NAME	15
	A to Z, 0 to 9, (space), ! " # \$ % & ( ) + , - . ; = @ [ ] ^ _ ' { } ~	
1A 05 0114	NETWORK RADIO NAME	16
	A to Z, a to z, 0 to 9, (space), ! " # \$ % & ' ( ) * + , - . / : ; < > = ? @ [ ] ^ _ ` { }   ~	
1A 05 0128	OPENING COMMENT	10
	A to Z, 0~9, (space), / @ - .	
1A 05 0134	NTP SERVER ADDRESS	64
	A to Z, a to z, 0~9, - .	

# Remote control

## ◇ Command formats (Continued)

### ● Memory channel content

Command: **1A 00**

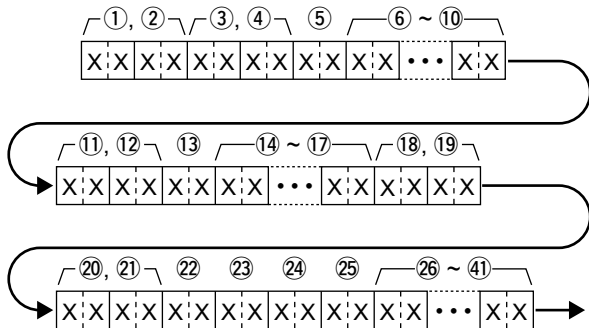

① In the modes other than FM and Digital, ④ and or later is not used. In the FM and Digital modes, entering ④ and or later can be omitted. The default value is applied to the omitted items.

#### ①, ② Memory group number

- 0000 ~ 0099: Normal memory channel group
- 0100: Auto Write Memory channel group
- 0101: Scan Skip channel group
- 0102: Programmable Scan Edge channel group

#### ③, ④ Memory channel numbers

- 0000 ~ 0099: Normal memory channel (00 ~ 99)
- Scan Skip channel (S00 ~ S99)
- Programmable Scan Edge channel (P00A, P00B ~ P49A, P49B)
- 0000 ~ 0199: Auto Write Memory channels (A000 ~ A199)

#### ⑤ Skip/Select Memory scan setting

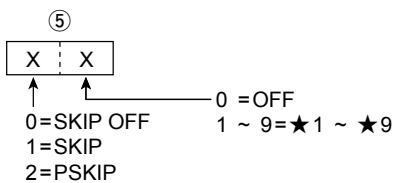

① Set "00" for the Programmable Scan Edge channel.

#### ⑥ ~ ⑩ Receiving frequency

Refer to "Receiving frequency" (p. 9)

#### ⑪, ⑫ Receiving mode

Refer to "Receiving mode" (p. 9)

#### ⑬ Duplex setting

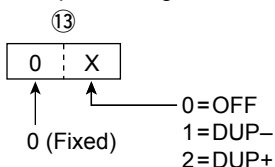

#### ⑭ ~ ⑰ Frequency offset

Refer to "Offset frequency" (p. 9)

#### ⑱, ⑲ Tuning step (TS)

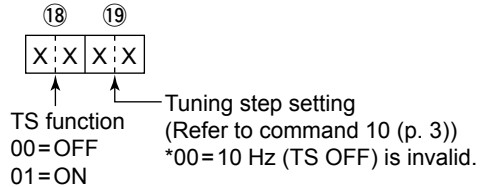

#### ⑳, ㉑ Programmable tuning step

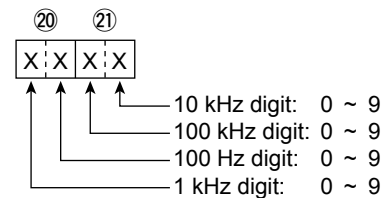

#### ㉒ Attenuator setting

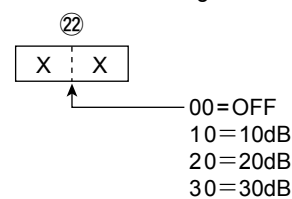

#### ㉓ Preamp setting

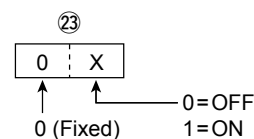

#### ㉔ Antenna setting

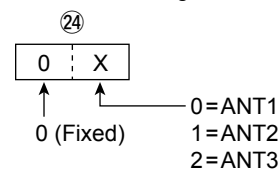

#### ㉕ IP plus (IP+) function

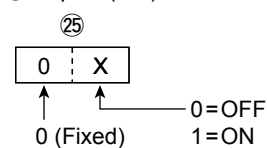

#### ⑳ ~ ㉑ Memory name (Up to 16 characters)

Refer to "Character entries" (p. 10)

# Remote control

## ◇ Command formats (Continued)

### ● Memory channel content

Command: **1A 00**

#### For receiving an FM signal

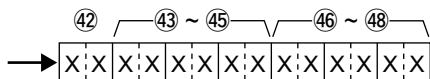

④② Tone squelch type

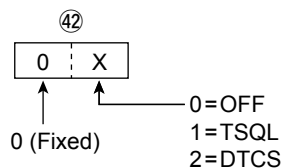

④③ ~ ④⑤ Tone squelch frequency  
Refer to "TSQL frequency" (p. 14)

④⑥ ~ ④⑧ DTCS code  
Refer to "DTCS code" (p. 14)

#### For receiving a P25 signal

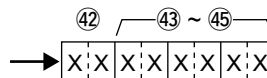

④② Digital squelch (D.SQL) type

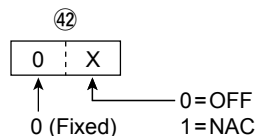

④③ ~ ④⑤ NAC

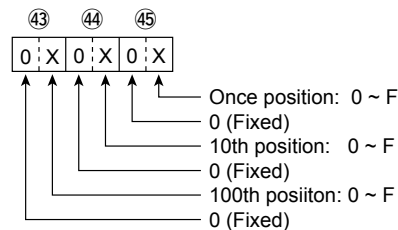

#### For receiving a D-STAR signal

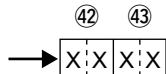

④② Digital squelch (D.SQL) type

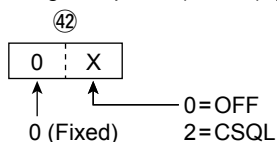

④③ Digital code squelch (CSQL) code

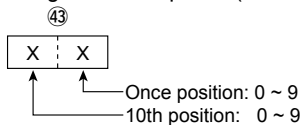





## Remote control

### ◇ Command formats (Continued)

#### ● D-STAR RX Call sign

Command: **20 0001, 20 0002**

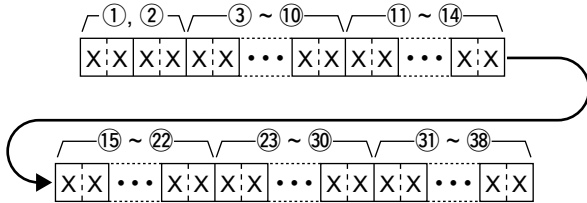

① Header flag data (First byte)

Data	Description
bit7	0 (Fixed) —
bit6	0 (Fixed) —
bit5	0 (Fixed) —
bit4	0/1 0=Voice, 1=Data
bit3	0/1 0=Direct, 1=Through repeater
bit2	0/1 0=No Break-in, 1=Break-in
bit1	0/1 0=Data, 1=Control
bit0	0/1 0=Normal, 1=EMR

② Header flag data (Second byte)

Data			Description
bit2	bit1	bit0	
1	1	1	Repeater control
1	1	0	Send auto acknowledge
1	0	1	(Not used)
1	0	0	Request to re-transmit
0	1	1	Send acknowledge
0	1	0	Receive no reply
0	0	1	Repeater disabled
0	0	0	NULL

③ ~ ⑩: Call sign of the CALLER station (8 characters)

⑪ ~ ⑭: Note of the CALLER station (4 characters)

⑮ ~ ⑲: CALLED station's call sign (8 characters)

⑳ ~ ㉓: RXRPT1's call sign (8 characters)

㉔ ~ ㉗: RXRPT2's call sign (8 characters)

①FF: No signal has been received since the power was turned ON.

#### ● D-STAR RX message

Command: **20 0101, 20 0102**

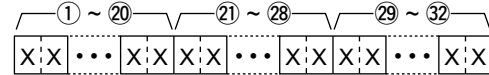

① ~ ⑳: Message (20 characters)

㉑ ~ ㉔: Call sign of the CALLER station (8 characters)

㉕ ~ ㉘: Note of the CALLER station (4 characters)

①FF: No signal has been received since the power was turned ON.

#### ● D-STAR RX STATUS

Command: **20 0201, 20 0202**

Data	Function	Description
bit7	0 (Fixed)	—
bit6	0/1 Receiving a voice call	While receiving a digital voice signal, "1" is returned. (Regardless of DSQL and CSQL setting)
bit5	0/1 Last call finisher	When the last call was finished by a user, "1" is returned.
bit4	0/1 Receiving a signal	When the audio tone can be heard, "1" is returned.
bit3	0/1 Receiving a BK call	While receiving a BK call, "1" is returned.
bit2	0/1 Receiving an EMR call	While receiving an EMR call, "1" is returned.
bit1	0/1 Receiving a signal other than D-STAR	While under an interference (Mode icon D-STAR and FM alternately blink), "1" is returned.
bit0	0/1 Packet loss status	While displaying a packet loss, "1" is returned.



# Remote control

## ◇ Command formats (Continued)

### ● D-STAR GPS/D-PRS data

Command: **20 0301, 20 0302**

#### • Data number and description

Data number	Description
00	D-PRS-Position
01	D-PRS-Object
02	D-PRS-Item
03	D-PRS-Weather

#### • GPS/D-PRS data— Position

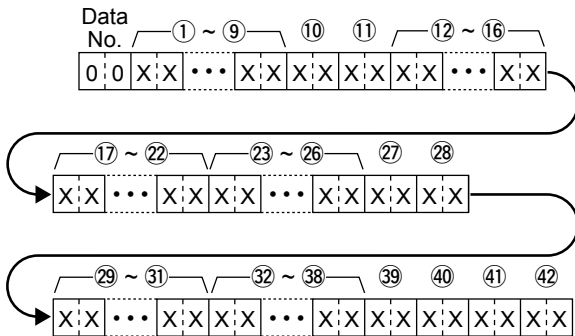

① ~ ⑨: Call sign/SSID

\*9 ASCII characters (A ~ Z, 0 ~ 9, /, -, space)

⑩, ⑪: Symbol

\*2 ASCII characters (00h ~ EFh)

⑫ ~ ⑯: Latitude (dd°mm.mmm format)

⑰ ~ ⑳: Longitude (ddd°mm.mmm format)

㉓ ~ ㉖: Altitude (0.1 meter steps)

㉗, ㉘: Course (1 degree steps)

㉙ ~ ㉚: Speed (0.1 km/h steps)

㉛ ~ ㉞: Date (UTC: yyyyymmddHHMMSS)

\* y: Year, m: Month, d: Day, H: Hour, M: Minute, S: Second

㉟: Power (see the table below)

㊱: Height (see the table below)

㊲: Gain (see the table below)

㊳: Directivity (see the table below)

Item Data	Power (W)	Height (m/ft)	Gain (dB)	Directivity (deg)
0	0	3/10	0	Omnidirectional
1	1	6/20	1	45°NE
2	4	12/40	2	90°E
3	9	24/80	3	135°SE
4	16	49/160	4	180°S
5	25	98/320	5	225°SW
6	36	195/640	6	270°W
7	49	390/1280	7	315°NW
8	64	780/2560	8	360°N
9	81	1561/5120	9	-

① The item, that is not contained the received data, is filled with "FF."

① FF: No signal has been received since the power was turned ON.

#### • GPS/D-PRS data— Object

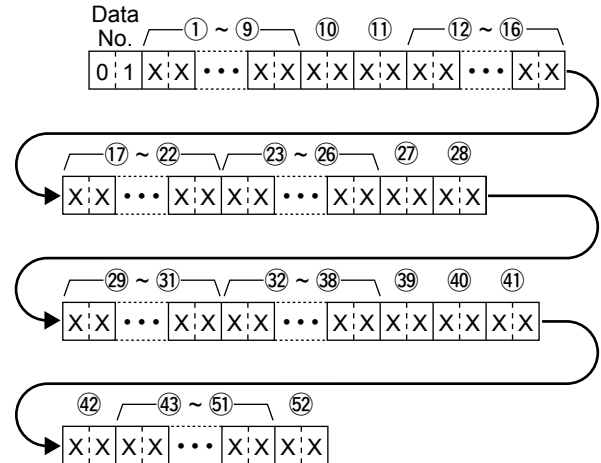

① ~ ⑨: Call sign/SSID

\*9 ASCII characters (A ~ Z, 0 ~ 9, /, -, space)

⑩, ⑪: Symbol

\*2 ASCII characters (00h ~ EFh)

⑫ ~ ⑯: Latitude (dd°mm.mmm format)

⑰ ~ ⑳: Longitude (ddd°mm.mmm format)

㉓ ~ ㉖: Altitude (0.1 meter steps)

㉗, ㉘: Course (1 degree steps)

㉙ ~ ㉚: Speed (0.1 km/h steps)

㉛ ~ ㉞: Date (UTC: yyyyymmddHHMMSS)

\* y: Year, m: Month, d: Day, H: Hour, M: Minute, S: Second

㉟: Power (see the table below)

㊱: Height (see the table below)

㊲: Gain (see the table below)

㊳: Directivity (see the table below)

Item Data	Power (W)	Height (m/ft)	Gain (dB)	Directivity (deg)
0	0	3/10	0	Omnidirectional
1	1	6/20	1	45°NE
2	4	12/40	2	90°E
3	9	24/80	3	135°SE
4	16	49/160	4	180°S
5	25	98/320	5	225°SW
6	36	195/640	6	270°W
7	49	390/1280	7	315°NW
8	64	780/2560	8	360°N
9	81	1561/5120	9	-

⑬ ~ ⑮: Name

\*9 ASCII characters (00h ~ EFh)

⑯: Type (1=Live, 0=Killed)

① The item, that is not contained the received data, is filled with "FF."

① FF: No signal has been received since the power was turned ON.

# Remote control

## ◇ Command formats (Continued)

### ● GPS/D-PRS data— Item

Command: **20 0301, 20 0302**

#### • Item

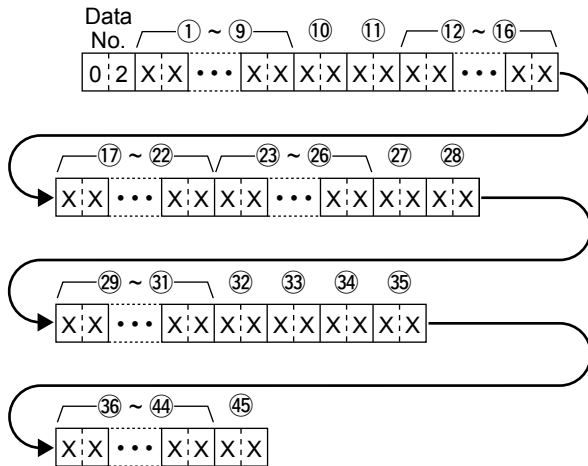

- ① ~ ⑨: Call sign/SSID  
\*9 ASCII characters (A ~ Z, 0 ~ 9, /, -, space)
- ⑩, ⑪: Symbol  
\*2 ASCII characters (00h ~ EFh)
- ⑫ ~ ⑯: Latitude (dd°mm.mmm format)
- ⑰ ~ ⑳: Longitude (ddd°mm.mmm format)
- ㉓ ~ ㉖: Altitude (0.1 meter steps)
- ㉗, ㉘: Course (1 degree steps)
- ㉙ ~ ㉚: Speed (0.1 km/h steps)
- ㉛: Power (see the table below)
- ㉜: Height (see the table below)
- ㉝: Gain (see the table below)
- ㉞: Directivity (see the table below)

Item Data	Power (W)	Height (m/ft)	Gain (dB)	Directivity (deg)
0	0	3/10	0	Omnidirectional
1	1	6/20	1	45°NE
2	4	12/40	2	90°E
3	9	24/80	3	135°SE
4	16	49/160	4	180°S
5	25	98/320	5	225°SW
6	36	195/640	6	270°W
7	49	390/1280	7	315°NW
8	64	780/2560	8	360°N
9	81	1561/5120	9	—

- ㉞ ~ ㉟: Name  
\*9 ASCII characters (00h–EFh)
- ㊱: Type (1=Live, 0=Killed)
- ① The item, that is not contained the received data, is filled with "FF."
- ①FF: No signal has been received since the power was turned ON.

#### • Weather

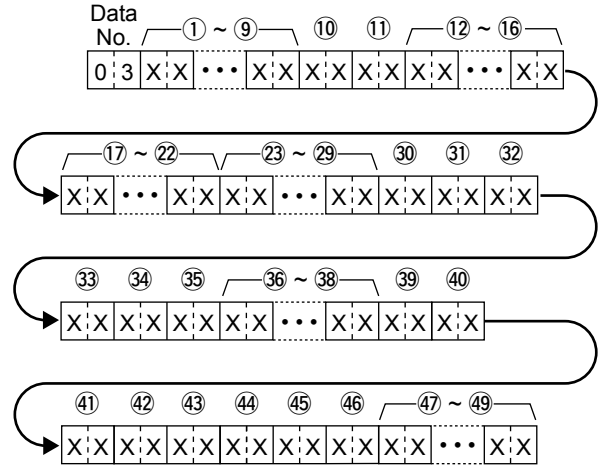

- ① ~ ⑨: Call sign/SSID  
\*9 ASCII characters (A ~ Z, 0 ~ 9, /, -, space)
- ⑩, ⑪: Symbol  
\*2 ASCII characters (00h ~ EFh)
- ⑫ ~ ⑯: Latitude (dd°mm.mmm format)
- ⑰ ~ ⑳: Longitude (ddd°mm.mmm format)
- ㉓ ~ ㉙: Date (UTC: yyyyymmddHHMMSS)  
\*y: Year, m: Month, d: Day, H: Hour, M: Minute, S: Second
- ㉚, ㉛: Wind direction (1 degree steps)
- ㉜, ㉝: Wind speed (0.1 m/s steps)
- ㉞, ㉟: Gust speed (0.1 m/s steps)
- ㊰ ~ ㊲: Temperature (0.1°C steps)
- ㊳, ㊴: Rainfall (1 hour) (0.1 mm steps)
- ㊵, ㊶: Rainfall (24 hours) (0.1 mm steps)
- ㊷, ㊸: Rainfall (Midnight) (0.1 mm steps)
- ㊹, ㊺: Humidity (1% steps)
- ㊻ ~ ㊽: Barometric pressure (0.1 hPa steps)
- ① The item, that is not contained the received data, is filled with "FF."
- ①FF: No signal has been received since the power was turned ON

### ● GPS/D-PRS message

Command: **20 0401, 20 0402**

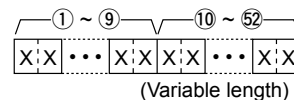

- ① ~ ⑨: Call sign/SSID  
\*9 ASCII characters (A ~ Z, 0 ~ 9, /, -, space)
- ⑩ ~ ㉚: Message  
\*Up to 43 ASCII characters (00h ~ EFh)
- ①FF: No signal has been received since the power was turned ON.

# Remote control

## ◇ Command formats (Continued)

### ● Digital code squelch setting

Command: **20 0501, 20 0502**

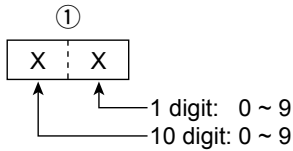

### ● P25 RX ID

Command: **20 0601, 20 0602**

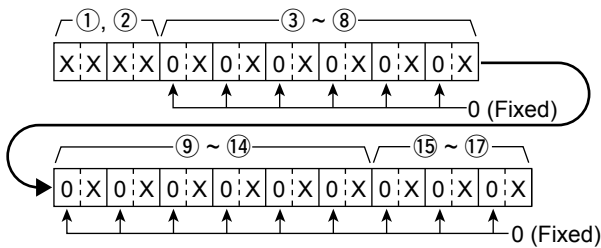

#### ① Header flag data (First byte)

Data	Description
<b>bit7</b> 0 (Fixed)	—
<b>bit6</b> 0	(Reserved)
<b>bit5</b> 0	(Reserved)
<b>bit4</b> 0	(Reserved)
<b>bit3</b> See the table below	Type of call
<b>bit2</b>	
<b>bit1</b> 0/1	0=Encryption OFF, 1=Encryption ON
<b>bit0</b> 0/1	0=Normal, 1=EMR

Data		Description
bit3	bit2	
1	1	All call
1	0	Group call
0	1	Individual call
0	0	Not identified

#### ② Header flag data (Second byte)

Data	Description
<b>bit7</b> 0 (Fixed)	—
<b>bit6</b> 0	(Reserved)
<b>bit5</b> 0	(Reserved)
<b>bit4</b> 0	(Reserved)
<b>bit3</b> 0	(Reserved)
<b>bit2</b> 0	(Reserved)
<b>bit1</b> 0	(Reserved)
<b>bit0</b> 0	(Reserved)

③ ~ ⑧: ID of the CALLER station (6 digits in Hexer decimal)

⑨ ~ ⑭: ID of the CALLED station (6 digits in Hexer decimal)

⑮ ~ ⑰: NAC (3 digits in Hexer decimal)

① If the NAC, CALLER or CALLED station is not identified,

"FF" is returned.

① FF: No signal has been received since the power was turned ON.

### ● P25 RX status data

Command: **20 0701, 20 0702**

Data	Function	Description
<b>bit7</b> 0 (Fixed)	—	—
<b>bit6</b> 0	—	(Reserved)
<b>bit5</b> 0/1	Interfere detection	While under an interference (Mode icon P25 and FM alternately blink), "1" is returned.
<b>bit4</b> 0/1	Receive status	While receiving a P25 signal, "1" is returned. (Regardless of NAC)
<b>bit3</b> 0/1	Last call finisher	When the last call was finished by a finisher, "1" is returned.
<b>bit2</b> 0/1	Receiving a signal	When the audio tone can be heard, "1" is returned.
<b>bit1</b> 0/1	Emergency call	While receiving an emergency call, "1" is returned.
<b>bit0</b> 0/1	Encryption	When the call is encrypted, "1" is returned.

### ● dPMR RX ID

Command: **20 0801, 20 0802**

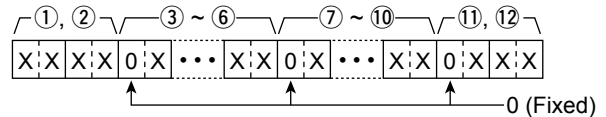

#### ① Header flag data (First byte)

Data	Description
<b>bit7</b> 0 (Fixed)	—
<b>bit6</b> 0	(Reserved)
<b>bit5</b> 0	(Reserved)
<b>bit4</b> 0/1	0=dPMR446, 1=Tier2
<b>bit3</b> See the table below	Type of call
<b>bit2</b>	
<b>bit1</b> 0/1	0=Scramble OFF, 1=Scramble ON
<b>bit0</b> 0	(Reserved)

Data		Description
bit3	bit2	
1	1	All call
1	0	(Not used)
0	1	Individual or Group call
0	0	Not identified

#### ② Header flag data (Second byte)

Data	Description
<b>bit7</b> 0 (Fixed)	—
<b>bit6</b> 0	(Reserved)
<b>bit5</b> 0	(Reserved)
<b>bit4</b> 0	(Reserved)
<b>bit3</b> 0	(Reserved)
<b>bit2</b> 0	(Reserved)
<b>bit1</b> 0	(Reserved)
<b>bit0</b> 0	(Reserved)

③ ~ ⑥ : ID of the CALLER station (7 digits in decimal)

⑦ ~ ⑩ : ID of the CALLED station (7 digits in decimal\*)

⑪ ~ ⑫ : CC/COM ID (2 or 3 digits in decimal)

\*If a wildcard is contained, corresponding digit is filled with "A."

① If the CC/COM ID, CALLER or CALLED station is not identified, "FF" is returned.

① FF: No signal has been received since the power was turned ON.

## Remote control

### ◇ Command formats (Continued)

#### ● dPMR RX status data

Command: **20 0901**, **20 0902**

Data	Function	Description
bit7	0 (Fixed)	—
bit6	0	(Reserved)
bit5	0/1	Interfere detection While under an interference (Mode icon dPMR and FM alternately blink), "1" is returned.
bit4	0/1	dPMR mode While receiving a dPMR Tier 2 signal, "1" is returned.
bit3	0/1	Receive status While receiving a dPMR signal, "1" is returned. (Regardless of CC or COM ID)
bit2	0/1	Last call finisher When the last call was finished by a user, "1" is returned.
bit1	0/1	Receiving a signal When the audio tone can be heard, "1" is returned.
bit0	0/1	Scrambler When the call is scrambled, "1" is returned.

#### ● NXDN RX Status data

Command: **20 0B01**, **20 0B02**

Data	Function	Description
bit7	0 (Fixed)	—
bit6	0	(Reserved)
bit5	0/1	Interfere detection While under an interference (Mode icon NXDN-VN/N and FM alternately blink), "1" is returned.
bit4	0/1	NXDN mode When the received NXDN signal is "Narrow," "1" is returned.
bit3	0/1	Receive status While receiving an NXDN signal, "1" is returned. (Regardless of RAN)
bit2	0/1	Last call finisher When the last call was finished by a user, "1" is returned.
bit1	0/1	Receiving a signal When the audio tone can be heard, "1" is returned.
bit0	0/1	Encryption When the call is encrypted, "1" is returned.

#### ● NXDN RX ID

Command: **20 0A01**, **20 0A02**

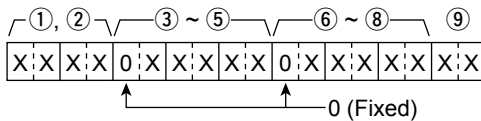

##### ① Header flag data (First byte)

Data	Description
bit7	0 (Fixed)
bit6	0 (Reserved)
bit5	0 (Reserved)
bit4	0/1 0=Very narrow, 1=Narrow
bit3	See the table below Type of call
bit2	
bit1	0/1 0=Encryption OFF, 1=Encryption ON
bit0	0 (Reserved)

Data	Description
bit3 bit2	
1 1	All call
1 0	Group call
0 1	Individual call
0 0	Not identified

##### ② Header flag data (Second byte)

Data	Description
bit7	0 (Fixed)
bit6	0 (Reserved)
bit5	0 (Reserved)
bit4	0 (Reserved)
bit3	0 (Reserved)
bit2	0 (Reserved)
bit1	0 (Reserved)
bit0	0 (Reserved)

③ ~ ⑤ : ID of the CALLER station (5 digits in decimal)

⑥ ~ ⑧ : ID of the CALLED station (5 digits in decimal)

⑨ : RAN (2 digits in decimal)

① If the RAN, CALLER or CALLED station is not identified, "FF" is returned.

② FF: No signal has been received since the power was turned ON.

## Remote control

### ◇ Command formats (Continued)

#### ● DCR RX ID

Command: **20 0C01**, **20 0C02**

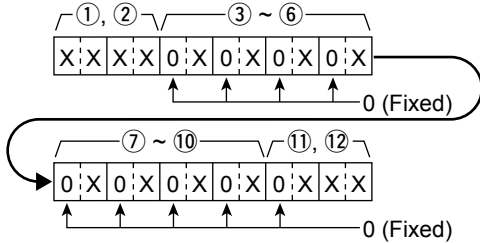

#### ① Header flag data (First byte)

Data	Description
bit7	0 (Fixed) —
bit6	0 (Reserved)
bit5	0 (Reserved)
bit4	0 (Reserved)
bit3	See the table below
bit2	
bit1	0/1 0=Encryption OFF, 1=Encryption ON
bit0	0 (Reserved)

Data		Description
bit3	bit2	
1	1	All call
1	0	Group call
0	1	Individual call
0	0	Not identified

#### ② Header flag data (Second byte)

Data	Description
bit7	0 (Fixed) —
bit6	0 (Reserved)
bit5	0 (Reserved)
bit4	0 (Reserved)
bit3	0 (Reserved)
bit2	0 (Reserved)
bit1	0 (Reserved)
bit0	0 (Reserved)

③ ~ ⑥: ID of the CALLER station (4 digits in Hexer decimal)

⑦ ~ ⑩: ID of the CALLED station (4 digits in Hexer decimal)

⑪, ⑫: UC (3 digits in decimal)

① If the UC, CALLER or CALLED station is not identified, "FF" is returned.

② FF: No signal has been received since the power was turned ON.

#### ● DCR RX Status data

Command: **20 0D01**, **20 0D02**

Data	Function	Description	
bit7	0 (Fixed)	—	
bit6	0	(Reserved)	
bit5	0	(Reserved)	
bit4	0/1	Interfere detection	While under an interference (Mode icon DCR and FM alternately blink), "1" is returned.
bit3	0/1	Receive status	While receiving a DCR signal, "1" is returned. (Regardless of UC)
bit2	0/1	Last call finisher	When the last call was finished by a user, "1" is returned.
bit1	0/1	Receiving a signal	When the audio tone can be heard, "1" is returned.
bit0	0/1	Encryption	When the call is encrypted, "1" is returned.

#### ● D-STAR RX data (transceive)

Command: **22 0101**

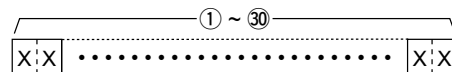

① ~ ⑩: Rx data (Up to 30 Bytes)

① "FA" to "FF" are entered after converted to "FF 0A" to "FF 0F" automatically. In this case, the data length can be up to 60 Bytes.

#### ● Selected or unselected VFO frequency

Command: **25**

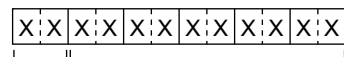

Refer to the receive frequency data

00: Fixed

# Remote control

## ◇ Command formats (Continued)

### ● Selected or unselected VFO's operating mode and filter

Command: **26**

① If you omit the data mode or filter setting, default setting is automatically applied.

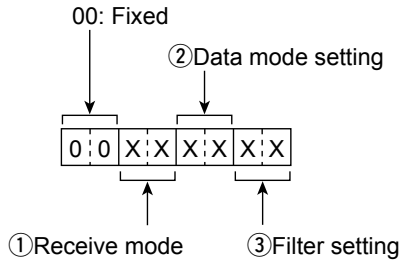

① Receiving mode		② Data mode	③ Filter
00: LSB	11: S-AM(D)	00: Fixed	01: FIL1
01: USB	14: S-AM(L)		02: FIL2
02: AM	15: S-AM(U)		03: FIL3
03: CW	16: P25		
04: FSK	17: D-STAR		
05: FM	18: dPMR		
06: WFM	19: NXDN-VN		
07: CW-R	20: NXDN-N		
08: FSK-R	21: DCR		

### ● Scope waveform data

Command: **27 00**

Outputs the waveform data to the controller.

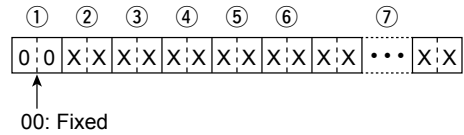

② Division number (NOW): 01 ~ 11

③ Division number (Maximum): 11 (USB)

When sent through the USB port, the data is divided by 11 and sent in sequential order.

① The divided data is not output from [LAN].

The division number (Maximum) means the maximum divided number.

The division number (Now) means the number that indicates the divided data location.

Example: Sending the 5th data of divided into 11.

The division number (Now) is "5," and the division number (Maximum) is "11."

① The 1st data sends only the wave information (① ~ ⑥) without the waveform data (⑦).

The 2nd or later data sends the minimum wave information (② ~ ③) with waveform data (⑦).

④ Center or Fixed mode data

00: Center mode scope

01: Fixed mode scope

⑤ Waveform information

The waveform information is different between Center mode and fixed mode.

In the Center mode: Center frequency and span are sent.  
Scope span setting (in the Center mode (② ~ ⑥) (p. 22)

In the Fixed mode: Lower edge and higher edge frequencies are sent.

Scope Fixed edge frequency settings (③ ~ ⑫) (p. 22)

⑥ Out of Range

00: In range

01: Out of range

① If the scope data is out of range, the waveform data (⑦) is not obtained.

⑦ Waveform data

Data range: 0 ~ 160

Data length: 475

# Remote control

## ◇ Command formats (Continued)

### ● Center/Fixed mode settings

Command: **27 14**

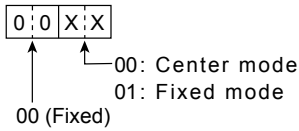

### ● Sweep speed settings

Command: **27 1A**

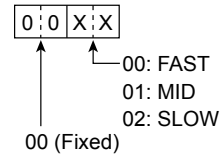

### ● Scope span settings (Only in the Center mode)

Command: **27 15**

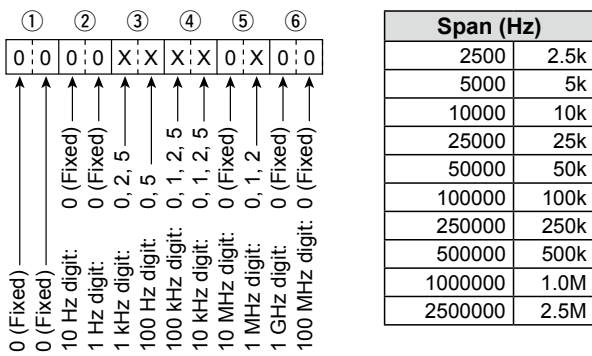

### ● VBW (Video Band Width) settings

Command: **27 1D**

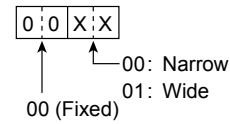

### ● Scope Hold settings

Command: **27 17**

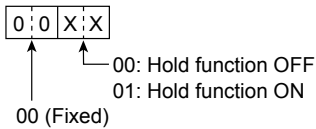

### ● Scope Reference level settings

Command: **27 19**

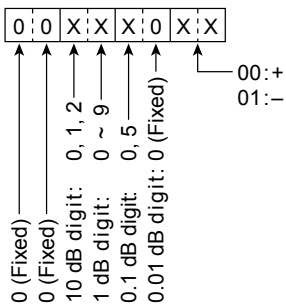

### ● Fixed edge frequency settings

Command: **27 1E**

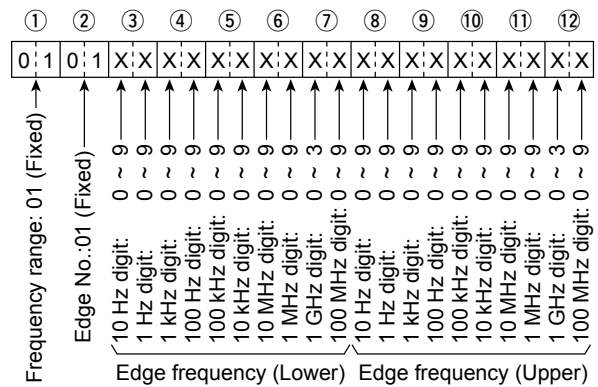

① Adjustable range: -20.0 dB ~ +20.0 dB (in 0.5 dB steps)

**Count on us!**

