



ADVANCED MANUAL

MARINE/LTE HYBRID
TRANSCEIVER
IP-M60

INTRODUCTION

1 ACCESSORIES

2 BEFORE USING

3 BASIC OPERATIONS

4 USING THE CELLULAR MODE

5 OTHER FUNCTIONS

6 SET MODE

7 FOR YOUR REFERENCE

INTRODUCTION

Thank you for choosing this Icom product. This product is designed and built with Icom's state of the art technology and craftsmanship. With proper care, this product should provide you with years of trouble-free operation.

IMPORTANT

FIRST, CAREFULLY READ INSTRUCTION MANUAL that is boxed with the transceiver.

SAVE THIS ADVANCED MANUAL— This advanced manual contains additional important operating instructions for the transceiver.

Icom and the Icom logo are registered trademarks of Icom Incorporated (Japan) in Japan, the United States, the United Kingdom, Germany, France, Spain, Russia, Australia, New Zealand, and/or other countries.

The Bluetooth® word mark and logos are registered trademarks owned by Bluetooth SIG, Inc. and any use of such marks by Icom Inc. is under license.

AQUAQUAKE is a trademark of Icom Incorporated.

All other products or brands are registered trademarks or trademarks of their respective holders.

Icom is not responsible for the destruction, damage to, or performance of any Icom or non-Icom equipment, if the malfunction is because of:

- Force majeure, including, but not limited to, fires, earthquakes, storms, floods, lightning, other natural disasters, disturbances, riots, war, or radioactive contamination.
- The use of Icom transceivers with any equipment that is not manufactured or approved by Icom.

Section 1 ACCESSORIES

Supplied accessories.....	1-2
Attaching accessories.....	1-2
◇ Antenna	1-2
◇ Battery pack.....	1-3
◇ Belt clip	1-3

Supplied accessories

Battery pack

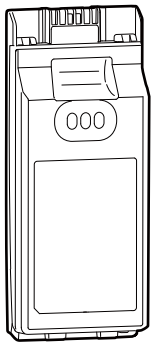

Belt clip



Connector cover and screw

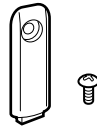

Flexible antenna

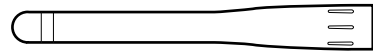

NOTE: Some accessories are not supplied, or the shape is different, depending on the transceiver version.

Attaching accessories

◇ Antenna

Connect an optional antenna to the antenna connector.

CAUTION:

- **DO NOT** carry the transceiver by holding only the antenna.
- **DO NOT** connect an antenna other than the supplied antenna, or those listed in this manual.
- **DO NOT** transmit without an antenna.

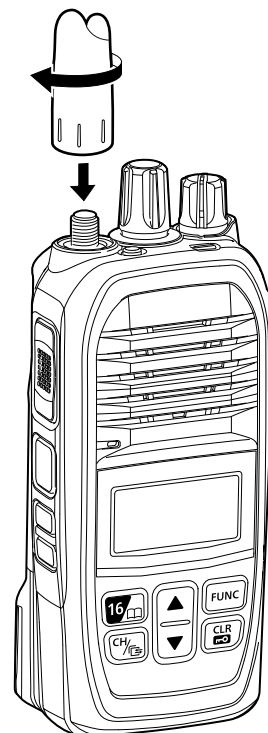

Attaching accessories

◇ Battery pack

CAUTION:

- **DO NOT** attach or detach the battery pack when the transceiver is wet or soiled. This may result in water or dust getting into the transceiver, or the battery pack may damage.
- Keep the battery pack terminals clean. It's a good idea to occasionally clean them.

To attach:

1. Slide the battery pack in the direction of the arrow. (1)
2. Push the battery pack until the battery sliding locks make a 'click' sound. (2)

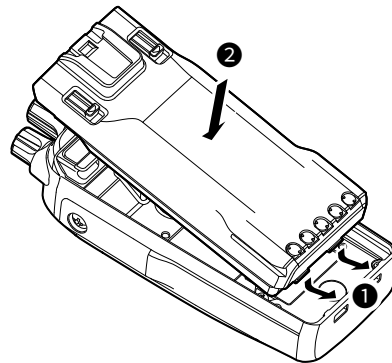

To detach:

1. Pull both battery sliding locks in the direction of the arrow. (1)
2. Lift up to detach the battery pack. (2)

Battery sliding locks

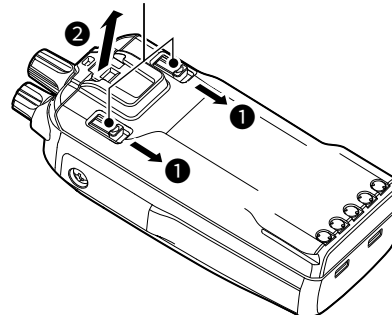

◇ Belt clip

To attach:

1. Remove the battery pack from the transceiver, if it is attached.
2. Slide the belt clip in the direction of the arrow until the belt clip is locked and makes a 'click' sound.

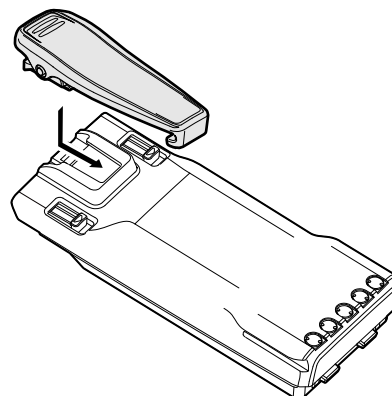

To detach:

1. Remove the battery pack from the transceiver, if it is attached.
2. Lift the tab up (1), and slide the belt clip in the direction of the arrow (2).

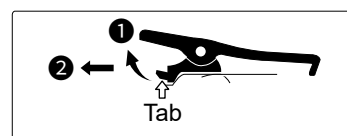

BE CAREFUL! DO NOT break your fingernail.

Section 2 BEFORE USING

Panel description	2-2
◇ Front, top, and side panels	2-2
◇ Status indicator	2-4
◇ Multi-connector	2-4
Function display.....	2-5
◇ Cellular mode.....	2-5
◇ Marine mode.....	2-6
◇ Cellular/Marine mode.....	2-6

Panel description

◇ Front, top, and side panels

Cellular mode

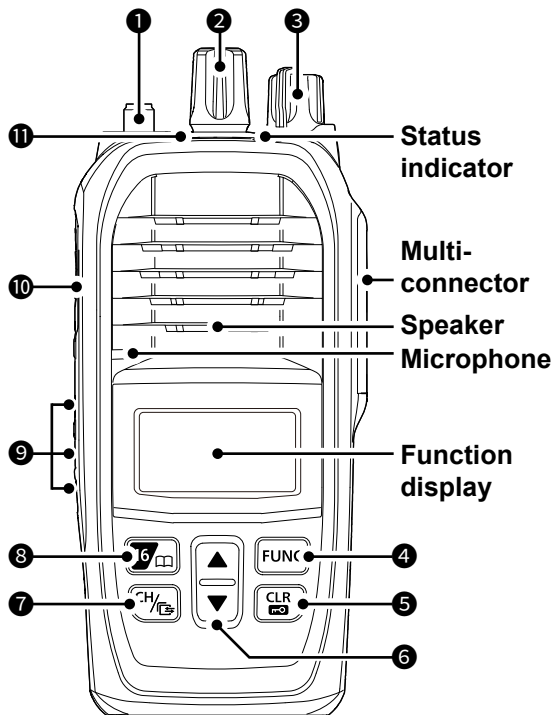

- 1 Antenna connector (p. 1-2)**
Connects the supplied antenna.
- 2 Rotary Selector**
Rotate to select a channel or scroll the screen.
- 3 [PWR/VOL]**
 - Rotate to turn the transceiver ON or OFF.
 - Rotate to adjust the audio output level.
- 4 [FUNC]**
 - Push to display the Function screen.
 - In the Function screen, push several times to select functions such as Operating mode selection, Talkgroup Selection, and so on.
 - ① Selectable functions may differ, depending on a Set mode setting.
- 5 [CLR/Lock]**
 - Push to return to the Standby screen.
 - Hold down for 1 second to turn the Key Lock function ON or OFF. (p. 3-2)
 - ① [Main PTT], [Sub PTT], [PWR/VOL], and [Emer] are usable even while the Key Lock function is ON.
- 6 [▲]/[▼]**
Push to select a channel or scroll the screen.

- 7 [CH/Call History]**
 - Push to display the Call history. (p. 4-6)
 - Push this key several times to switch between the Call history types, Transmitted call, Received call, Sent message, Received message, Recording log, and Phone call log.
 - Hold down for 1 second to playback a selected Recording log. (p. 5-10)
- 8 [16/Address]**
 - Selects a preset address.
 - Push to switch the Address Book between the call types. (p. 4-2)
- 9 [Sub PTT]/[Side 1]/[Side 2]**
Functions may be assigned, depending on a presetting.
You can also assign functions in the Detailed Set mode.
See page 4-8 for assignable function details.

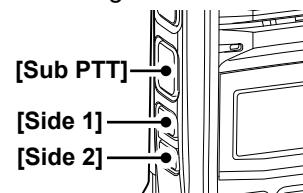

- 10 [Main PTT]**
Hold down to transmit, release to receive.
- 11 [Emer]**
Hold down until "Emergency" is displayed to send an Emergency call. (p. 5-6)

Panel description

◇ Front, top, and side panels

Marine mode

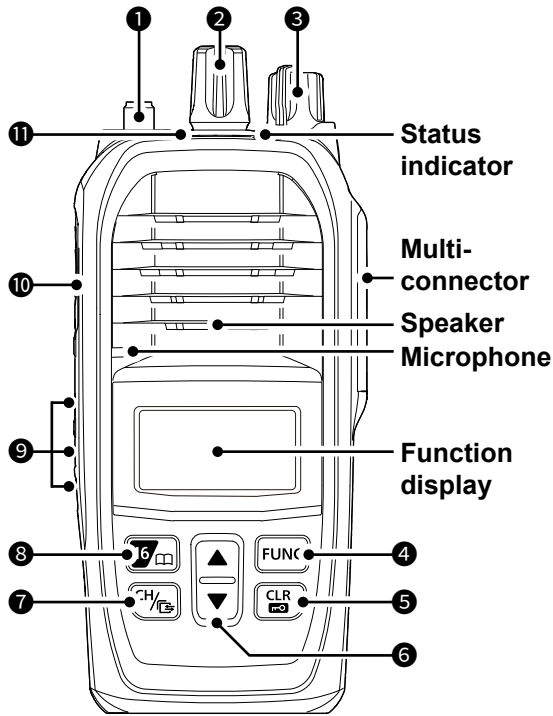

- 1 Antenna connector (p. 1-2)**
Connects the supplied antenna.
- 2 Rotary Selector**
Rotate to select a channel or scroll the screen.
- 3 [PWR/VOL]**
 - Rotate to turn the transceiver ON or OFF.
 - Rotate to adjust the audio output level.
- 4 [FUNC]**
 - Push to display the Function screen.
 - In the Function screen, push several times to select functions such as Operating selection, Channel group selection, and so on.
 - ① Selectable functions may differ, depending on a Set mode setting.
- 5 [CLR/Lock]**
 - Push to return to the Standby screen.
 - Hold down for 1 second to turn the Key Lock function ON or OFF. (p. 3-2)
 - ① [Main PTT], [Sub PTT], [PWR/VOL], and the Monitor function are usable even while the Key Lock function is ON.
- 6 [▲]/[▼]**
Push to select a channel or scroll the screen.

- 7 [CH/Call History]**
 - Push to switch between a regular channel and the Weather channel.
 - Hold down for 1 second to set the output power high or low.
 - ① Some channels are set to only low power.
- 8 [16/Address]**
 - Push to select Channel 16.
 - Hold down for 1 second to select the Call channel.
 - ① See the boxed Instruction manual for details.
- 9 [Sub PTT]/[Side 1]/[Side 2]**
Functions may be assigned, depending on a presetting.
You can also assign functions in the Detailed Set mode.
See page 6-8 for assignable functions.

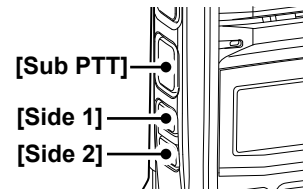

- 10 [Main PTT]**
Hold down to transmit, release to receive.
- 11 [Emer]**
This key cannot be used in the Marine mode.

Panel description

◇ **Status indicator**

Cellular mode

- Lights red: Transmitting.
- Lights green: Receiving.
- Lights yellow: Receiving and transmitting in the Full-Duplex mode.

Marine mode

- Lights red: Transmitting.
- Lights green: Receiving or the squelch is open.

◇ **Multi-connector**

Connect an optional speaker microphone or headset.

CAUTION: DO NOT use the transceiver without the connector cover or optional equipment attached. The transceiver meets IP67 requirements for dust-tight and waterproof protection only when the connector cover or the specified optional speaker microphone is attached. See page 7-5 for the usable speaker microphones.

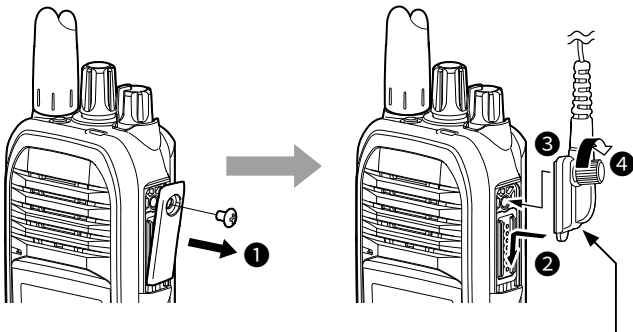

CAUTION: Firmly attach to the Multi connector, but do not overtighten. A loose connection will allow water intrusion into the connector. Over-tightening the connection can damage the transceiver.

Function display

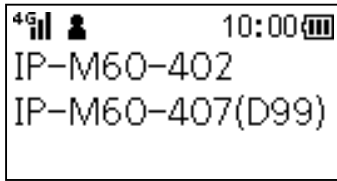

Cellular mode

◇ Cellular mode

Indicator	Description
	Displays the signal strength level by 3 bars. ① A connected network type (4G or 3G) is displayed on the left top.
	<ul style="list-style-type: none"> Blinks when the transceiver location is out of the service area or cannot receive a control signal. Displayed if the transceiver has not been authenticated. ① A connected network type (4G or 3G) is displayed on the left top.
	All/Group Call
	Talkgroup Call*
	Individual Call
	Phone Call*
	<ul style="list-style-type: none"> Displayed when the Pocket Beep function is ON. (p. 4-7) Blinks when a call is received. It blinks until the transceiver returns to the Standby mode after a received signal disappears.
	Displayed when the P-Bell function is ON. (p. 4-7)
	Displayed when the Emergency Call function is ON. (p. 5-6)
	<ul style="list-style-type: none"> Displayed when the Voice Record function is ON. (p. 5-10) Blinks while recording audio.
F	Blinks when the transceiver is downloading a new firmware.

* May be usable, depending on a presetting.

“F” blinks while downloading a new firmware:

- Do not turn OFF the transceiver until the download is finished. Place the transceiver in a good signal level area. Downloading takes approximately 10 minutes.
- After the downloading is finished, the firmware update will start. Updating takes approximately 1 minute.
- Do not turn OFF the transceiver. The transceiver will automatically restart when the update is finished.

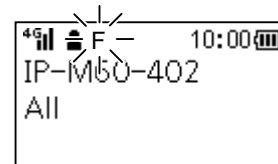

- ① If “F” has been displayed for more than 10 minutes, reboot the transceiver.
- ① If the battery status indication is (nearing exhaustion) or (exhausted), the firmware update will not start. Charge the battery pack, then restart the transceiver and do the firmware update.

Function display



Marine mode

◇ Marine mode

Indicator	Description
Low	Displayed when low output power is selected. ① Blinks when the transceiver temperature becomes high.
INT/ USA/ CAN/ ATIS/ WX	Displays the current channel group. ① The selectable channel group differs, depending on the transceiver version.
WX	Displayed when the WX Alert is ON. ① The function may not be usable, depending on the transceiver version.
DUP	Displayed when a Duplex channel is selected.
SCAN	Displayed while scanning.
DUAL/ TRI	“DUAL” or “TRI” and the watched channel number are displayed while using the Dualwatch or Tri-Watch function.
CALL	Displayed when a Call channel is selected.
★	Displayed when a Favorite channel is selected.

◇ Cellular/Marine mode

Indicator	Description
✳	Displayed when Bluetooth is activated. (p. 5-3)
📶	Displayed when a Bluetooth device is connected. (p. 5-3)
🔒	Displayed when the Key Lock function is ON. (p. 3-2)
VOX	Displayed when the VOX function is ON.
🔋	Displays the remaining battery charge. 🔋 : Full 🔋 : Mid 🔋 : Charging required 🔋 : Battery exhausted
A	Displayed when the transceiver is in the Adaptive PTT mode. (p. 5-13)

Section 3 BASIC OPERATIONS

Turning ON the transceiver	3-2
Adjusting the volume level.....	3-2
Using the Key Lock function	3-2
Function screen	3-2
AquaQuake Water Draining function	3-3
Selecting the operation mode.....	3-3

Turning ON the transceiver

For only the European version:

When you turn ON the transceiver for the first time, the “Model” screen is displayed, depending on the presetting. Select the country where you operate the transceiver.

NOTE: Before using the transceiver for the first time, the battery pack must be fully charged for optimum life and operation. See the BATTERY CHARGING section on the boxed Instruction manual.

- Rotate [PWR/VOL] clockwise to the 12 o'clock position to turn ON the transceiver.
 - ① The dial is made tight for dust and water resistance.
 - ① To turn OFF the transceiver, rotate [PWR/VOL] counter-clockwise until it makes a “click” sound.
 - ① An opening text may be displayed, depending on a presetting.

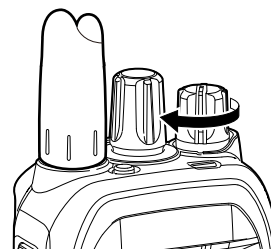

Adjusting the volume level

- Rotate [PWR/VOL] to adjust the volume level.
 - ① The volume level adjustment screen is displayed while adjusting.
 - ① Push [CLR/Lock] to return to the Standby screen.

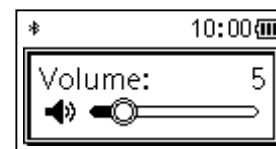

Using the Key Lock function

You can use the Key Lock function to prevent accidental channel changes and unnecessary function access, depending on a presetting.

Keys and functions except the following are electronically locked:

[Main PTT], [Sub PTT], [PWR/VOL], [Emer], and the Monitor function.

- Hold down [CLR/Lock] for 1 second to turn the Key Lock function ON or OFF.
 - ① “” is displayed while the function is ON.



Function screen

In the Function screen, you can select the functions by pushing [FUNC].

- ① Selectable functions may differ, depending on the transceiver version.
- ① The following keys can be used in the Function screen, depending on the operating mode.
 - Cellular mode: [Main PTT] and [CLR/Lock]
 - Marine mode: [Main PTT], [16/Address], [CLR/Lock], and [Sub PTT] that assigned “Marine PTT”

Routes to the Function screens:

Routes to the Function screens are in the following manner.

Instruction example: [FUNC] > **Mode Select**

AquaQuake Water Draining function

Water in the speaker grill may muffle the sound coming from the speaker. The AquaQuake Water Draining function removes water from the speaker grill by vibrating the speaker.

① Confirm that “AquaQuake” is assigned to [Sub PTT], [Side 1], or [Side 2]. You can assign functions in the Set mode. (p. 6-8)

NOTE: When an external speaker microphone is connected, the AquaQuake Water Draining function cannot be used.

- Hold down the key that is assigned to “AquaQuake.”
 - A low frequency vibration drains the water, regardless of the volume level setting.
 - The volume level adjustment screen is displayed while holding down the key.
 - ① This function is activated for a maximum of 10 seconds, even if you continue to hold down the key.
- Release the key to turn OFF the function.
 - The volume level returns to the original level.

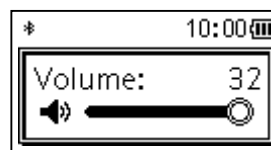

Selecting the operation mode

You can select the operating mode, as shown below. See the page shown below for instructions on each operation mode.

Cellular mode: Section 4 (p. 4-1)

Makes a call with IP transceivers using a cellular network.

- This mode can be used when the transceiver is within the range of the cellular network.
- Two types of communication, the Full Duplex mode and the Simplex mode, can be used.

Marine mode: See the boxed Instruction manual

Makes a call with VHF marine transceivers.

This mode is used for maritime communication.

Cellular + Marine mode: Section 5 (p. 5-12)

You can use the Cellular mode and Marine mode at the same time.

In the Cellular + Marine mode, simultaneous transmission and reception on IP transceivers and VHF marine transceivers is possible.

NOTE: The Relay mode relays received VHF marine audio to the cellular transceiver group, while transferring the cellular radio conversations to the VHF marine transceivers. See page 5-14 for details.

- Open the “Mode Select” screen.
 - [FUNC] > **Mode Select**
- Rotate the Rotary Selector or push [▲] or [▼] to select an operating mode “Cellular,” “Marine,” “Cellular + Marine,” or “Relay,”
 - ① Some modes may not be selectable, depending on the presetting.
- Push [CH/Call History].
 - The operating mode is selected, and then returns to the Standby screen.

Example: Selecting the Cellular + Marine mode

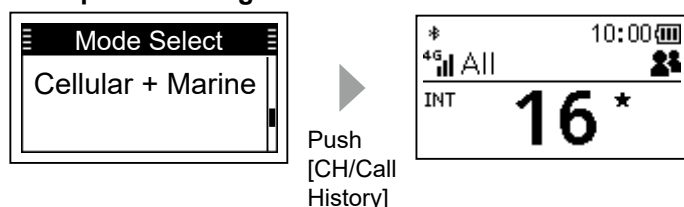

Section 4

USING THE CELLULAR MODE

Basic operation.....	4-2
◇ Selecting a call-to party	4-2
◇ Receiving and transmitting	4-2
Advanced operation.....	4-3
◇ About the Talkgroup Call.....	4-3
◇ Selecting a Talkgroup number	4-4
◇ Sending a message (Message Call).....	4-5
◇ Browsing received messages	4-6
◇ Status Call	4-6
◇ Switching the SIM card	4-7
◇ Pocket Beep function.....	4-7
◇ P-Bell function.....	4-7
Using assignable keys.....	4-8

Basic operation

NOTE: LTE operation requires SIM insertion. Contact your dealer for details.

◇ Selecting a call-to party

1. Push [16/Address] to display the Address book.
 - ① The Address book is displayed.
2. Push [16/Address] several times to switch the call type.
 - ① The selectable call type may differ, depending on the presetting.
3. Rotate the Rotary Selector or push [▲] or [▼] to select a call-to party.

◇ Receiving and transmitting

Receiving:

- When a call is received, the Status indicator lights green.

Transmitting:

- While holding down [Main PTT], speak at your normal voice level.
 - ① The Status indicator lights red while [Main PTT] is held down.

Talk while receiving a call:

- While receiving a call, push [Main PTT] to talk in the Full-Duplex mode* like a telephone call.
 - ① In the Full-Duplex mode, the Status indicator lights yellow.
 - * Usability depends on a presetting. Ask your dealer for details.

TIP: To maximize the readability of your transmitted signal, pause for a second after pushing [Main PTT] and hold the microphone 5 to 10 cm (2 to 4 inches) from your mouth, and then speak at your normal voice level.

About the call type:

- All call: Transmit to all of the transceivers that belong to the network.
- Group call: Transmit to the transceivers that belong to the same group.
- Talkgroup call: Transmit to the transceivers that belong to the same Talkgroup.
- Individual call: Transmit to an individual transceiver.
- Telephone call: Transmit to an IP phone (Transmittable, depending on the presetting).

NOTE:

- The Time-out Timer function cuts off transmission after 5 minutes of continuous transmission to prevent prolonged transmission.
A beep sounds 10 seconds before the TOT function cuts off the transmission. After the cut-off, you cannot transmit for 60 seconds.
- The Noise Cancel function reduces random noise components in the transmit signal.

Advanced operation

◇ About the Talkgroup Call

The Talkgroup Call function enables users to communicate with call-to parties in the same Talkgroup. For example, in the illustration below, when the IP-M60 “00105” in its normal group “10002” selects Talkgroup “20001,” it is excluded from group “10002,” and can communicate with only the transceivers “00004” and “00108” that belong to Talkgroup “20001.”

- ① This function can be used only when the Talkgroup number is registered, and the Talkgroup Call function is assigned to a key by your dealer.
- ② Ask your dealer whether or not to include a Talkgroup in the All Call.

When Talkgroup is OFF

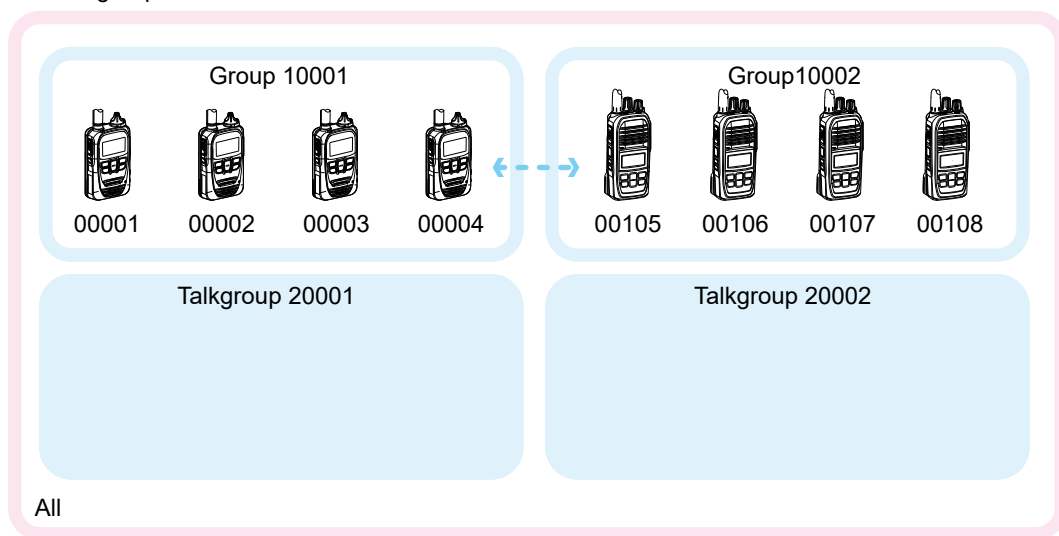

When Talkgroup is selected

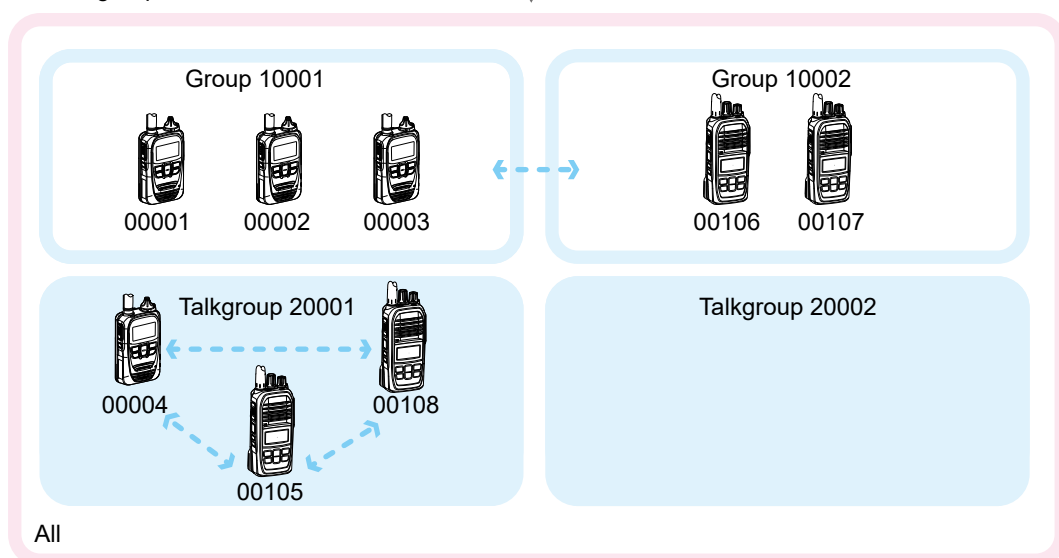

Advanced operation

◇ Selecting a Talkgroup number

You can select a Talkgroup number if the Talkgroup Call function is assigned to the [FUNC] key. Ask your dealer for details.

1. Push [FUNC] to display the function.
 - The Function screen is displayed.
2. Push [FUNC] to display "Talkgroup," if another function is displayed.
 - ① You may need to push [FUNC] several times, depending on the presetting.
3. Rotate the Rotary Selector or push [▲] or [▼] to select a Talkgroup number you want to belong to.
4. Push [CLR/Lock].
 - The transceiver is ready to talk to only the transceivers that belong to the same Talkgroup.
 - ① While the Talkgroup number is selected, you cannot transmit a Normal Group call.
 - ① You can leave the Talkgroup and return to the Normal Group by selecting "OFF" in Step 3 on the "Talkgroup" screen.

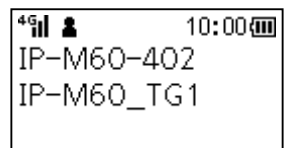
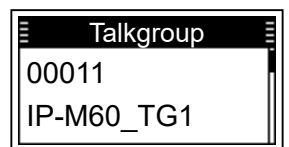
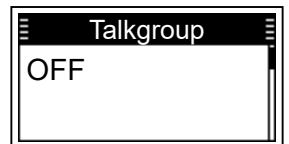

Advanced operation

◇ Sending a message (Message Call)

You can send a message, depending on the presetting. Ask your dealer for details.

1. Selecting a call-to party

1. Push [16/Address] to display the Address book.
 - The Address book is displayed.
2. Push [16/Address] several times to switch the call type. (Example: Individual call)
 - ① Displayed call types may differ, depending on the presetting.

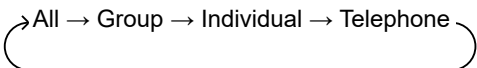

3. Rotate the Rotary Selector or push [▲] or [▼] to select a call-to party.

TIP: You can also select a call-to party from the Call history.

1. Push [CH/Call History] to display the Call history.
 - The Call history is displayed.
2. Push [CH/Call History] several times to switch the Call history between “TX log,” “RX log,” and “TX MSG log.”
 - ① The displayed log may differ, depending on the presetting.

3. Rotate the Rotary Selector or push [▲] or [▼] to select a call-to party.

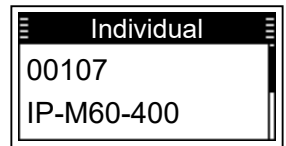

2. Sending a message

Sending a preset message:

1. Push [FUNC] to display the function.
 - The Function screen is displayed.
2. Push [FUNC] to display “Message,” if another function is displayed.
 - ① You may need to push [FUNC] several times, depending on the presetting.
3. Rotate the Rotary Selector or push [▲] or [▼] to select a message to send.
 - The selected message may scroll, depending on the message length.
4. Push [Main PTT] to send a message.
 - ① “Sending...” is displayed while holding down [Main PTT].
 - ① When the Call type is set to “Individual,” the call result (Successful/No response) is displayed after sending.

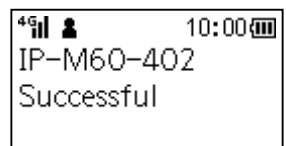
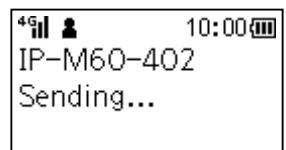
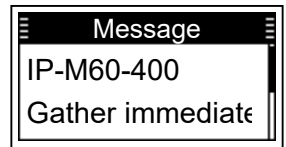

Advanced operation

◇ Browsing received messages

You can browse received messages, depending on the presetting. Ask your dealer for details.

1. Push [CH/Call History] to display the Call history.
 - The Call history is displayed.
2. Push [CH/Call History] to display “RX MSG log.”
 - ① You may need to push [CH/Call History] several times, depending on the presetting.
3. Rotate the Rotary Selector or push [▲] or [▼] to browse received messages.
 - ① The selected message may scroll, depending on the message length.

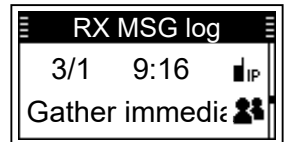

◇ Status Call

You can send a Status call, depending on the presetting. Ask your dealer for details.

1. Push [FUNC] to display the function.
 - The Function screen is displayed.
2. Push [FUNC] to display “Status,” if another function is displayed.
 - ① You may need to push [FUNC] several times, depending on the presetting.
3. Rotate the Rotary Selector or push [▲] or [▼] to select a status.
4. Push [Main PTT] to send a status.

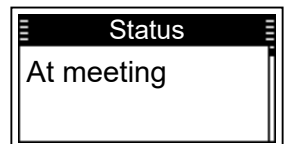

Advanced operation

◇ Switching the SIM card

The transceiver has 2 SIM card slots, SIM 1 and SIM 2. You can switch the SIM card to use in the Detailed Set mode.

1. Turn OFF the transceiver, if it is turned ON.
2. While holding down [16/Address] and [FUNC], rotate [PWR/VOL] to turn ON the transceiver.
 - The Detailed Set mode is displayed.
 - ① Release [16/Address] and [FUNC] when "SET (Detail)" is displayed.
3. Rotate the Rotary Selector or push [▲] or [▼] to select an item group "Cellular," and then push [FUNC].
4. Push [16/Address] or [FUNC] several times to select "SIM Selection."
5. Rotate the Rotary Selector or push [▲] or [▼] to select a SIM card.
 - ① The SIM card name may be displayed, if it is entered.
6. Push [CLR/Lock] to exit "SIM Selection."
 - ① Push [CLR/Lock] again to exit the Detailed Set mode and return to the Standby screen.

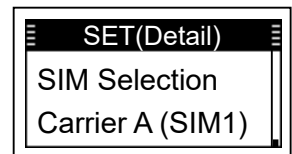
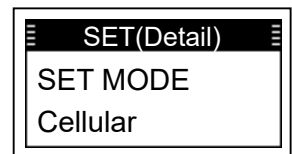

TIP: You can also push [FUNC] to display the "SIM Selection" screen by enabling the "Show SIM selection" in the Detailed Set mode (p. 6-6).

◇ Pocket Beep function

The Pocket beep function sounds a notification tone and indication when a call is received.

- ① This function is set by your dealer, or in the Set mode.
- ① "🔔" is displayed when the function is ON.
- ① "🔔" blinks and the notification beep sounds when a call is received. It blinks until the transceiver returns to the Standby mode after a received signal disappears.

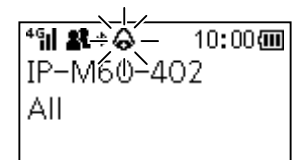

◇ P-Bell function

The P-Bell function sounds a notification tone when a call is received. A received call is muted until you reply. After pushing [Main PTT], the mute is released.

- ① This function is set by your dealer, or in the Set mode.
- ① "P" is displayed when the function is ON.

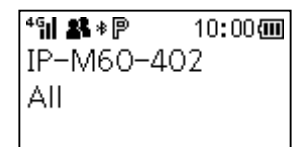

Using assignable keys

Functions shown below may be assigned to the [Sub PTT], [Side 1], and [Side 2] keys in the Cellular mode, depending on the presetting.

Hold down or push these keys to use the assigned functions.

You can also assign these functions in the Detailed Set mode. (p. 6-5)

Function	Descriptions
Message	<p>Push to directly display the Message screen.</p> <p>① The Message screen displayed by the first push differs, depending on the presetting.</p>
One Touch	<p>Push to directly select a particular call-to party.</p> <p>① The selectable call-to party differs, depending on the presetting.</p>
AquaQuake	<p>While holding down this key, the AquaQuake Water Draining function removes water from the speaker grill by vibrating the internal speaker.</p> <p>① Water in the speaker grill may muffle the sound coming from the speaker.</p> <p>① After the specified period of time, this function automatically stops, even if a user continues to hold down this key.</p> <p>① This key works with only the internal speaker. When an external speaker microphone is connected, the AquaQuake Water Draining function cannot be used.</p>

① See the boxed Instruction manual for details about the assignable functions for the Marine mode.

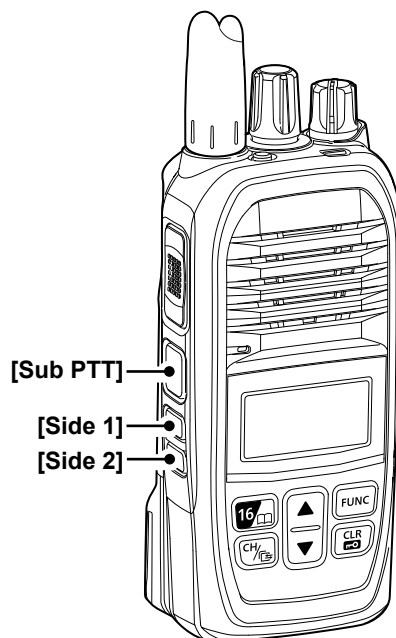

Using a Bluetooth® device	5-2
◇ About the VS-3 Bluetooth headset	5-2
◇ Pairing with a Bluetooth device.....	5-3
◇ Settings for the Bluetooth function.....	5-3
◇ Disconnecting a paired device.....	5-4
◇ Deleting a Bluetooth device from the pairing list.....	5-4
◇ Initializing the Pairing list	5-5
Using the Emergency Call function	5-6
◇ The Man Down function.....	5-7
◇ The Lone Worker function.....	5-8
◇ The Stationary Detection function.....	5-9
◇ The Motion Detection function	5-9
Using the Voice Recorder function	5-10
◇ Using the Voice Recorder function	5-10
◇ Deleting the recorded audio.....	5-11
Using the Cellular + Marine mode	5-12
◇ Selecting the Cellular + Marine mode.....	5-12
◇ Main mode and Sub mode.....	5-12
◇ Transmitting	5-12
◇ Receiving	5-12
◇ Adaptive PTT mode	5-13
Using the Relay mode	5-14
◇ Selecting the Relay mode.....	5-14
◇ Relaying a signal	5-14

Using a Bluetooth® device

NOTE:

Connect with a device that complies with the standards set by Bluetooth SIG and has been certified. Even if the device complies with the Bluetooth standard, it may not be able to connect to the receiver, depending on the specifications and settings of the device, and not all operations are guaranteed.

The transceiver can operate with Bluetooth headsets.

① Only the VS-3 headset performance is guaranteed as of March 2024.

- The Bluetooth function may not be usable, depending on the presetting. Ask your dealer for details.
- The communication range of Bluetooth is approximately 10 m (33 ft).
 - ① The range may vary, depending on the environment in which the device operates.
- Although you can enter up to 6 Bluetooth devices in the transceiver device list, it is recommended that you pair only 1 device at a time.

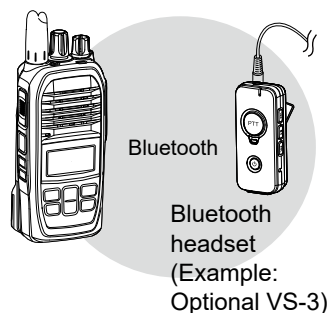

Electromagnetic Interference

When you use a Bluetooth device, pay attention to the following:

Bluetooth devices operate in the 2.4 GHz band that is also used by other appliances, such as Wireless LAN products, microwave ovens, RFID systems, amateur radio stations, and so on.

When using a Bluetooth device near such devices, interference may occur, causing a decreased communication speed, and an unstable connection.

In such cases, keep the Bluetooth devices away from the other appliances, or stop using those devices.

Bringing the Bluetooth device and the transceiver closer together also improves communication.

◆ **About the VS-3 Bluetooth headset**

When connecting an optional VS-3 Bluetooth headset to the transceiver, you can wirelessly transmit and receive the headset audio.

The VS-3 has a [PTT] switch, so you can transmit in the same way as using the transceiver’s [Main PTT] switch.

- The [FWD], [RWD], and [PLAY] keys on the VS-3 are disabled while using the headset with the IP-M60.

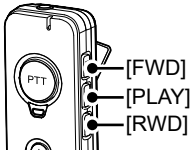

- If the headset does not work correctly, even if the power is ON, push [RESET] with a pin to force power OFF.

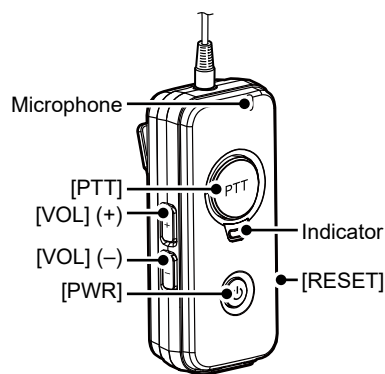

Function		Operation	Beep tone	Indicator
Bluetooth function	ON	Hold down [PWR] for 3 seconds	Melody (up)	Blinks blue
	OFF		Melody (down)	OFF
Pairing mode	Searching	While the Bluetooth function is OFF, hold down [PWR] for 6 seconds	PiPa- (ready to connect)	Quickly blinks red, then blue, every 3 seconds
	Connected		PiRo	Blinks blue twice every 3 seconds
Transmit*1		Push [PTT]	Pi*2	Blinks red once, then blue twice, every 3 seconds
Audio volume	Up*1	Push [VOL] (+)	Pi	—
	Down*1	Push [VOL] (–)	Boo	—

*1 Functional only when a Bluetooth device is connected.

*2 Depends on the Notice Tone settings or “BT PTT Beep” setting in the Set mode.

Using a Bluetooth® device

◇ Pairing with a Bluetooth device

This is an example of connecting the transceiver to a VS-3 Bluetooth headset.

1. Entering the VS-3 Pairing mode

1. Confirm the VS-3 is turned OFF.
2. Hold down [PWR] for 6 seconds.
 - The indicator quickly blinks red, then blue, and then the headset enters the Pairing mode.

NOTE:

- Charge the VS-3 before operating.
- The VS-3 starts up in the Pairing mode when its Bluetooth function is ON, but no Bluetooth device is entered in its pairing list.

2. Enable the transceiver's Bluetooth function

1. Turn OFF the transceiver, if it is turned ON.
2. While holding down [FUNC], rotate [PWR/VOL] to turn ON the transceiver.
 - The Set mode is displayed.
 - ① Release [FUNC] when "SET" is displayed.
3. Rotate the Rotary Selector or push [▲] or [▼] to select an item group "Common," and then push [FUNC].
4. Push [FUNC] or [16/Address] several times to select "Bluetooth."
5. Rotate the Rotary Selector or push [▲] or [▼] to select "ON."

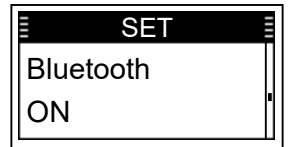

3. Pairing and connecting the Bluetooth device

1. Push [FUNC] or [16/Address] several times to select "Search BT Device" in the Set mode, and then push [CH/Call History].
 - "Searching..." is displayed and the transceiver searches for a Bluetooth device.
 - ① Push [CLR/Lock] to cancel searching.
 - If found, the device's name and Bluetooth Device address are displayed on the screen. (Example: ICOM BT-002)
2. Push [▲] or [▼] to select the headset to pair and connect, and then push [CH/Call History].
 - "Connect" is displayed when the pairing has been completed.
3. Push [CLR/Lock] to exit "Search BT Device."
 - ① Push [CLR/Lock] again to exit the Set mode and return to the Standby screen.
 - "BT" is displayed when the headset is correctly paired.

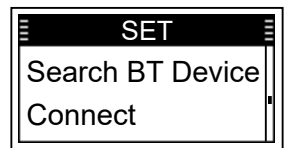
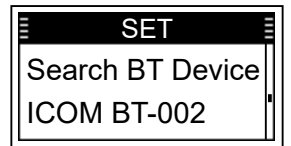
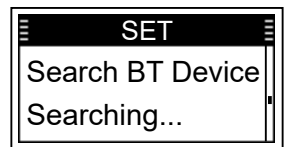
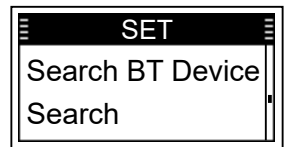

◇ Settings for the Bluetooth function

You can customize the transceiver's Bluetooth settings in the Set mode. See the Set Mode section for details. (pp. 6-3, 6-4)

Using a Bluetooth® device

◇ **Disconnecting a paired device**

You can disconnect a paired Bluetooth device if it is not being used.

1. In the Standby screen, push [FUNC] several times to select “Pairing List.”
2. Push [▲] or [▼] to select the device to disconnect, and then push [CH/Call History].
 - “Unconnected” is displayed if the headset or device is correctly disconnected.
 - ① To reconnect to the Bluetooth device, do the same steps.

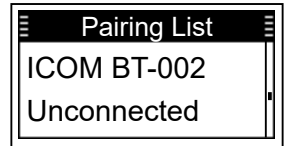

◇ **Deleting a Bluetooth device from the pairing list**

You can delete Bluetooth devices from the “Pairing List” screen.

① Disconnect the Bluetooth device before deleting if connected.

1. Turn OFF the transceiver, if it is turned ON.
2. While holding down [FUNC], rotate [PWR/VOL] to turn ON the transceiver.
 - The Set mode is displayed.
 - ① Release [FUNC] when “SET” is displayed.
3. Rotate the Rotary Selector or push [▲] or [▼] to select an item group “Common,” and then push [FUNC].
4. Push [FUNC] or [16/Address] several times to select “Delete BT Device.”
5. Rotate the Rotary Selector or push [▲] or [▼] to select the device to delete.
6. Push [CH/Call history].
 - “Delete?” is displayed.
 - To cancel deleting, push any key other than [CH/Call history].
7. Push [CH/Call history].
 - “Completed to delete” is displayed, and the selected device is deleted from the pairing list.

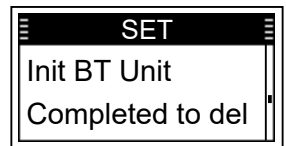
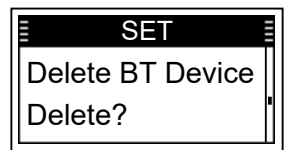
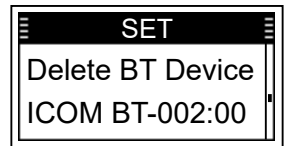

Using a Bluetooth® device

◇ **Initializing the pairing list**

If you have problems with Bluetooth operation, initialize the pairing list, as shown below.

Initializing the pairing list of the transceiver

- ① All the paired Bluetooth devices are deleted from the pairing list by the initialization.
- ① The pairing list is also initialized by the RESET function in the Detailed Set mode.
 1. Turn OFF the transceiver, if it is turned ON.
 2. While holding down [FUNC], rotate [PWR/VOL] to turn ON the transceiver.
 - The Set mode is displayed.
 - ① Release [FUNC] when “SET” is displayed.
 3. Rotate the Rotary Selector or push [▲] or [▼] to select an item group “Common,” and then push [FUNC].
 4. Push [FUNC] or [16/Address] several times to select “Init BT Unit.”
 5. Rotate the Rotary Selector or push [▲] or [▼] to select “Clear.”
 6. Push [CH/Call History] to initialize the pairing list.
 - The pairing list is initialized, and the transceiver automatically restarts.

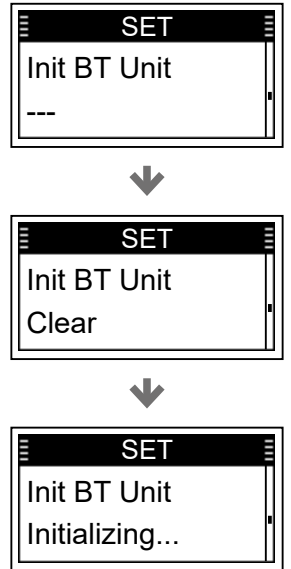

Initializing the pairing list of the VS-3

1. Hold down [PWR] on the VS-3 for 3 seconds to turn ON the Bluetooth function.
 - The indicator blinks blue.
2. Hold down [PWR] on the VS-3 for 3 seconds again to turn OFF the Bluetooth function.
 - The indicator turns OFF.
3. Within 10 seconds, while holding down both [VOL] (+) and [VOL] (-), hold down [PWR] for 10 seconds.
 - The indicator lights violet, and then turns OFF after the pairing list is initialized.

Using the Emergency Call function

NOTE: The Emergency function can be used only in the Cellular mode.

You can transmit or receive an Emergency call when the function is enabled.

Transmitting:

The instruction is for when the function is enabled. Ask your dealer for details.

1. Hold down [Emer] until “Emergency” is displayed.
 - An alarm periodically sounds.
2. Wait for an answer back.
 - When the transceiver receives an answer, the alarm stops, and the Status indicator lights green.
 - ① To cancel the Emergency call, turn OFF the transceiver.
 - ① The transceiver automatically transmits a repeat Emergency call until it receives an acknowledgment or until a user turns OFF the transceiver.

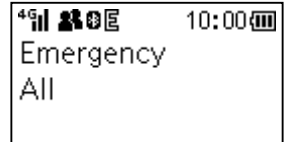

Receiving:

When an emergency call has been received, “Emergency” is displayed, and the display periodically blinks.

- ① The alarm periodically sounds, and/or the transceiver periodically vibrates, depending on the presetting.
- While holding down [Main PTT], talk into the microphone.
 - The blinking screen, alarm, and/or vibration stops.
 - ① While holding down [Main PTT], the status indicator lights red.
 - ① After releasing [Main PTT], the transceiver returns to the Standby screen.

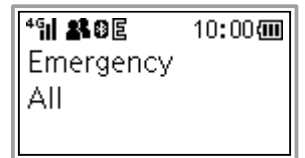

The display periodically blinks.

NOTE: The Emergency function may not properly work, depending on the surrounding environment, such as obstructions, weather conditions, and so on. Icom is not responsible for the destruction or damage caused by the Emergency Call function.

Using the Emergency Call function

The transceiver enters the Emergency mode through the following functions, depending on the presetting:

◇ **The Man Down function**

When the transceiver is tilted past the preset angle for the ON Timer preset time, the transceiver enters the Emergency mode.

- ① If a user raises the transceiver back from the preset angle towards the vertical position before the Reminder Timer set time expires, the Emergency mode is canceled.

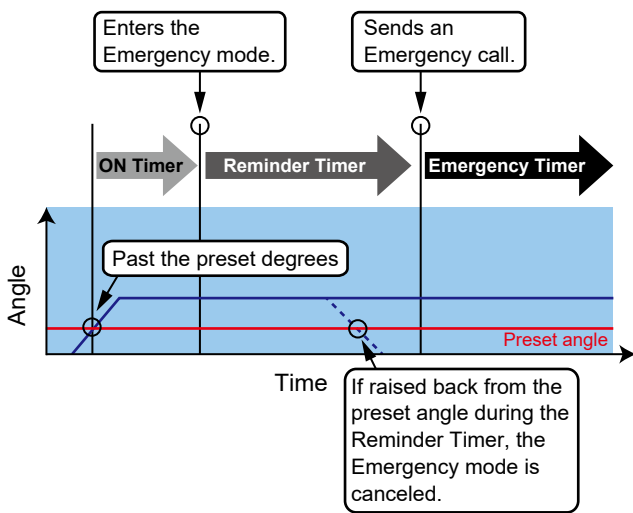

Man Down With Stationary:

- The transceiver leans past the preset angle for the ON Timer preset time.
- AND
- The transceiver is detected as stationary (no motion) for the ON Timer set time.
- ① If a user raises the transceiver back from the preset angle towards the vertical position or when the user moves the transceiver before the Reminder Timer set time expires, the Emergency mode is canceled.

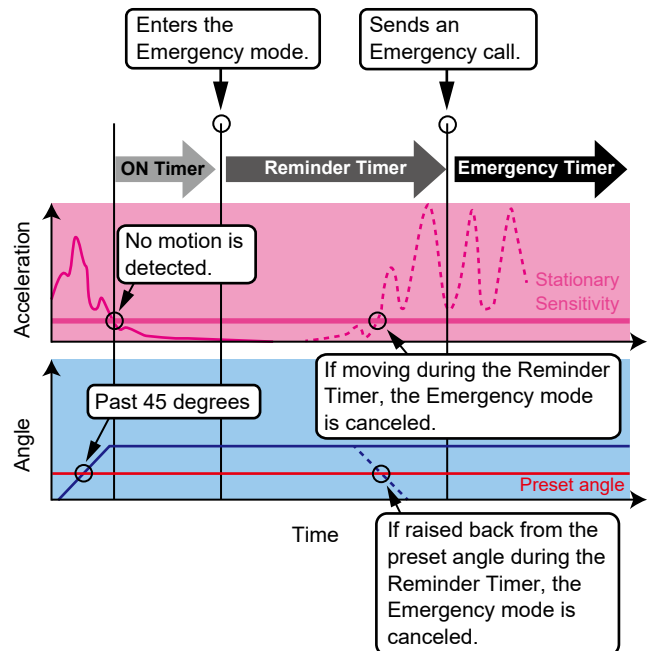

NOTE: The Man down function may not properly work, depending on the surrounding environment, such as obstructions, weather conditions, and so on. Icom is not responsible for the destruction or damage caused by the Man Down function.

Using the Emergency Call function

The transceiver enters the Emergency mode through the following functions, depending on the presetting:

◇ The Lone Worker function

When no operation occurs for the ON Timer preset time, the transceiver enters the Emergency mode.

- ① If a user pushes any key before the Reminder Timer set time expires, the Emergency mode is canceled.

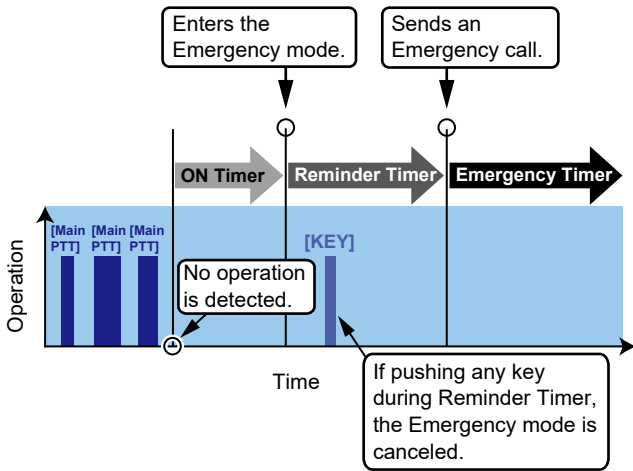

Lone Worker With Stationary:

- When no operation occurs for the ON Timer preset time.
- AND
- The transceiver is detected as stationary (no motion) for the ON Timer set time.
- ① If a user pushes any key or moves the transceiver before the Reminder Timer set time expires, the Emergency mode is canceled.

Example:

- ON Timer: 60 minutes
- Reminder Timer: 60 seconds

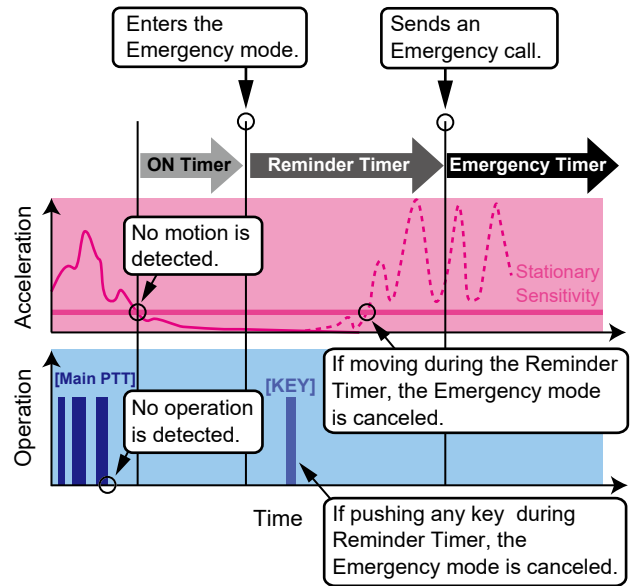

NOTE: The Lone Worker function may not properly work, depending on the surrounding environment, such as obstructions, weather conditions, and so on. Icom is not responsible for the destruction or damage caused by the Lone Worker function.

Using the Emergency Call function

The transceiver enters the Emergency mode through the following functions, depending on the presetting:

◇ The Stationary Detection function

When the transceiver is detected as stationary (no motion) for the ON Timer preset time, the transceiver enters the Emergency mode.

- ① If a user moves the transceiver during the Reminder Timer set time, the Emergency mode is canceled.

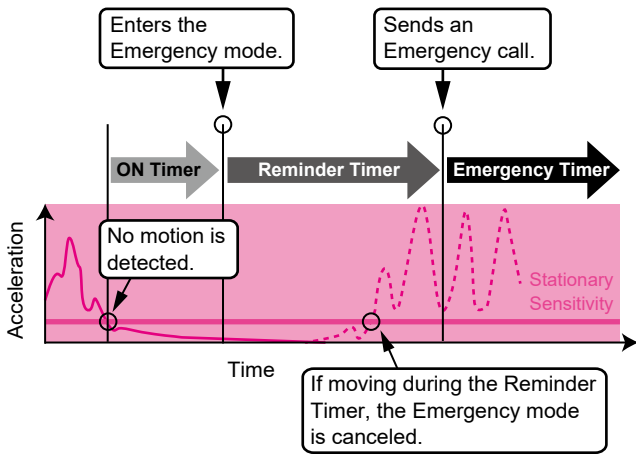

NOTE: The Stationary Detection function may not properly work, depending on the surrounding environment, such as obstructions, weather conditions, and so on.
Icom is not responsible for the destruction or damage caused by the Stationary Detection function.

◇ The Motion Detection function

When the transceiver continuously moves for the ON Timer preset time, the transceiver enters the Emergency mode.

- ① If a user holds down [Emer] for the Emer SW OFF Timer (Sec) set time, before the Reminder Timer set time expires, the Emergency mode is canceled.

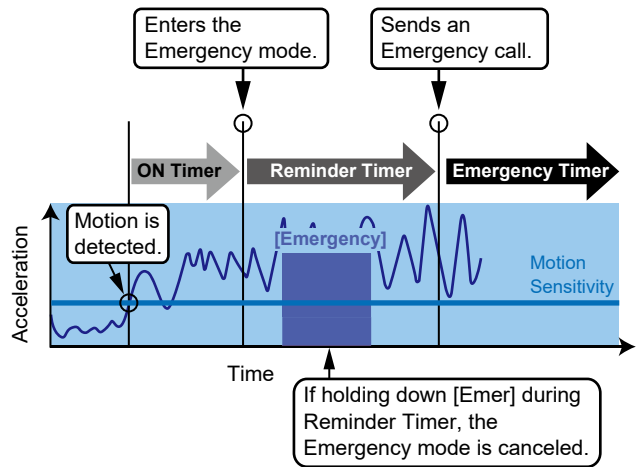

NOTE: The Motion Detection function may not properly work, depending on the surrounding environment, such as obstructions, weather conditions, and so on.
Icom is not responsible for the destruction or damage caused by the Motion Detection function.

Using the Voice Recorder function

NOTE: The Voice Recorder function can be used only in the Cellular mode.

The transceiver can record and playback up to 10 of the latest incoming calls, depending on the presetting.

- ① Records are up to 4 minutes per call. If a call is longer than 4 minutes, the older one will be automatically deleted.
- ① The recordable call type may differ, depending on the presetting.
- ① Recorded audio data cannot be exported.
- ① This function does not record analog audio.

◇ Using the Voice Recorder function

1. Enable the Voice Recorder function

1. Turn OFF the transceiver, if it is turned ON.
2. While holding down [FUNC], rotate [PWR/VOL] to turn ON the transceiver.
 - The Set mode is displayed.
 - ① Release finger from [FUNC] when “SET” is displayed.
3. Rotate the Rotary Selector or push [▲] or [▼] to select an item group “Cellular,” and then push [FUNC].
4. Push [FUNC] or [16/Address] several times to select “Recording.”
5. Rotate the Rotary Selector or push [▲] or [▼] to select “ON.”
6. Push [CLR/Lock] to exit “Recording.”
 - ① Push [CLR/Lock] again to exit the Set mode and return to the Standby screen.

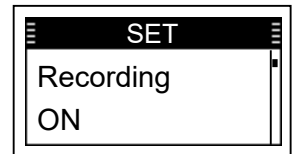

2. Turning ON the Voice Recorder function

1. Push [FUNC] to display the Function.
 - The Function screen is displayed.
2. Push [FUNC] to display “Recording,” if another function is displayed.
 - ① You may need to push [FUNC] several times, depending on the presetting.
3. Rotate the Rotary Selector or push [▲] or [▼] to select “ON.”
4. Push [CLR/Lock] to return to the Standby screen.
 - “” is displayed.

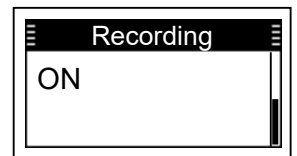

3. Playing back the recorded audio

“” blinks when there is recorded audio that has not been played back.

1. Push [CH/Call History] to display the Function.
 - The Call History is displayed.
2. Push [CH/Call History] several times to select “Recording log.”
 - ① You can select all Call history from “TX log,” “RX log,” “TX MSG log,” “RX MSG log,” or “Recording Log” by rotating the Rotary Selector or pushing [▲] or [▼].
 - TX log → RX log → TX MSG log → RX MSG log → Recording log →
 - ① The displayed log may differ, depending on the presetting.
3. Rotate the Rotary Selector or push [▲] or [▼] to select an audio to playback.
4. Hold down [CH/Call History] for 1 second to playback the audio.
 - ① Push [▲] or [▼] to stop playing back the audio.

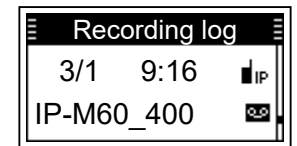

Using the Voice Recorder function

◇ **Deleting the recorded audio**

1. Turn OFF the transceiver, if it is turned ON.
2. While holding down [FUNC], rotate [PWR/VOL] to turn ON the transceiver.
 - The Set mode is displayed.
 - ① Release finger from [FUNC] when “SET” is displayed.
3. Rotate the Rotary Selector or push [▲] or [▼] to select an item group “Cellular,” and then push [FUNC].
4. Push [FUNC] or [16/Address] several times to select “Delete Recording.”
5. Rotate the Rotary Selector or push [▲] or [▼] to select “Clear.”
6. Push [CH/Call History] to delete the recorded audio.
 - “Deleting...” is displayed while deleting the recorded audio.
 - “---” is displayed after the deletion is finished.
7. Push [CLR/Lock] to exit “Delete Recording.”
 - ① Push [CLR/Lock] again to exit the Set mode and return to the Standby screen.

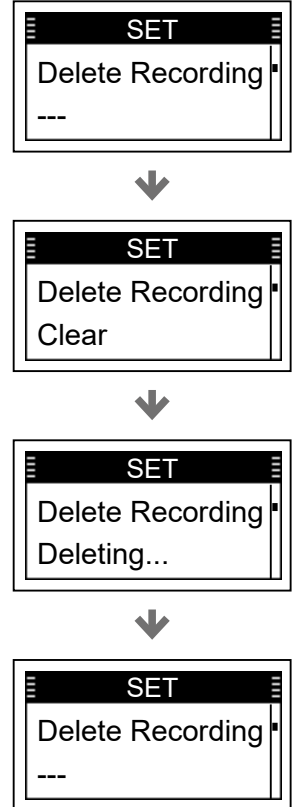

Using the Cellular + Marine mode

You can use the Cellular mode and Marine mode at the same time. In the Cellular + Marine mode, simultaneous transmission and reception on IP transceivers and VHF marine transceivers is possible.

◇ Selecting the Cellular + Marine mode

1. Open the “Mode Select” screen.
 [FUNC] > **Mode Select**
2. Rotate the Rotary Selector or push [▲] or [▼] to select “Cellular + Marine.”
3. Push [CH/Call History].
 - The Cellular + Marine mode is selected, and then returns to the Standby screen.

◇ Main mode and Sub mode

When the Cellular + Marine mode is selected, the Main mode and Sub mode are displayed, as shown to the right.

Switching the operating mode:

- Hold down [FUNC] for 1 second to switch the operating mode.
 - ① Displayed operating modes may differ, depending on the presetting.

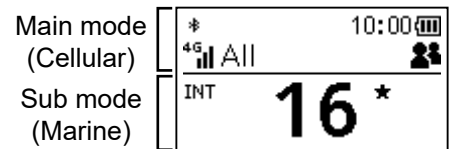

Example

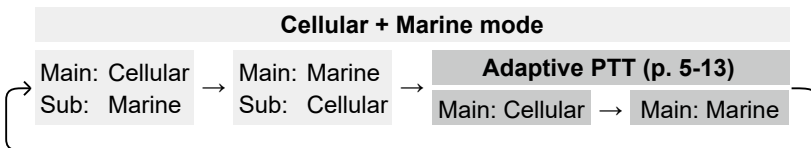

NOTE: Functions below are not usable in the Cellular + Marine mode.

Cellular mode functions:

- Sending a message

Marine mode functions:

- Scanning
- Dualwatch/Tri-Watch

Common functions:

- VOX function
- P-Bell function
- Power Save function

◇ Transmitting

- Hold down [Main PTT] to transmit in the Main mode.
- Hold down [Sub PTT] to transmit in the Sub mode.
 - ① You can also simultaneously transmit in both modes by holding down [Main PTT] and [Sub PTT].
 - ② A VHF marine channel, call-to party, or call type is not selectable in the Sub mode. To select those, switch to the Main mode.

◇ Receiving

- When signals have been received in both modes at the same time, you will hear the received audio mixed.
 - ① The volume difference can be set between the Main and Sub modes. Ask your dealer for details.

Using the Cellular + Marine mode

◇ Adaptive PTT mode

In the Adaptive PTT mode, only the Main mode is displayed, and the transceiver automatically selects the transmission mode.

To enter the Adaptive PTT mode:

- Hold down [FUNC] for 1 second once or twice in the Cellular + Marine mode.
 - When the transceiver enters the Adaptive PTT mode, “A” and “+” are displayed.
 - ① When “+” is displayed, valid GPS position data is received.
 - When “+” blinks, no position data is received.
 - ① When signals have been received in both modes at the same time, only the signal in the mode set to Main can be heard.



Example:
Main: Marine

The Adaptive PTT mode has 2 functions to automatically select the transmission mode. You can use either or both functions, depending on the presetting.

Talk Back function:

When the transceiver receives a signal, the Main mode is temporarily switched to the received operating mode.

While holding down [Main PTT], the transceiver transmits in that mode.

- ① If no transmission is performed for a certain period of time, the Main mode will return to the original operating mode.

Adaptive PTT area:

When the transceiver enters an area preset as an Adaptive PTT area, the operating mode will be switched to the mode set for use within that area.

While holding down [Main PTT], the transceiver transmits in the currently selected operating mode.

- ① If no position data is received, this function cannot be used.
- ① Up to 30 areas can be registered. Ask your dealer for details.

Using the Relay mode

The Relay mode relays received VHF marine audio to the cellular transceiver group, while transferring the cellular radio conversations to the VHF marine transceiver group.

This function is useful when communicating outside of the cellular service coverage with VHF marine transceivers.

① The Relay mode may not be usable, depending on the presetting.

Example:

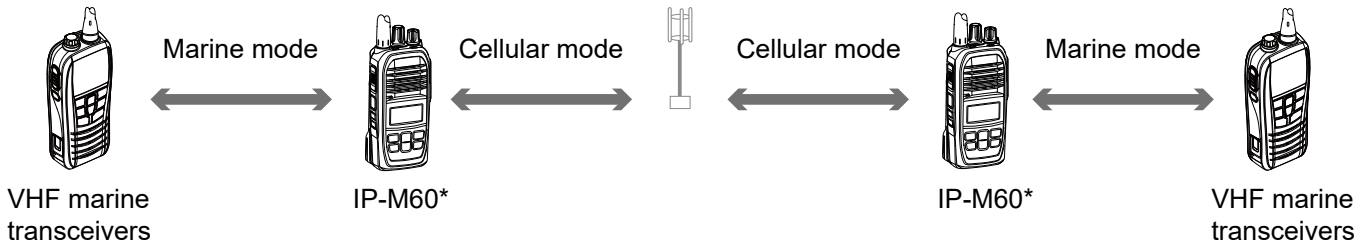
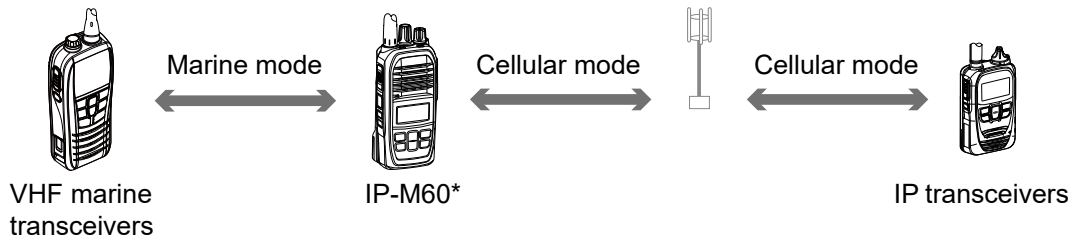

* The transmit power for the Marine mode will be reduced to 1 W.

NOTE:

- The Relay mode operation consumes more battery power.
- The Relay mode causes audio degradation by converting to a different voice codec.
- Communication delays may increase, depending on the state of the Cellular line.
- The Relay mode operation may be prohibited in some countries. Check the legal requirements in your country before using the function.

◇ Selecting the Relay mode

1. Open the "Mode Select" screen.
[FUNC] > **Mode Select**
2. Rotate the Rotary selector or push [▲] or [▼] to select "Relay."
3. Push [CH/Call History].
• The Relay mode is selected, and then returns to the Standby screen.

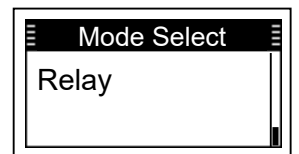

◇ Relaying a signal

- When a signal is received in one mode, it is relayed in the other mode.
 - "MRN◀IP" is displayed while relaying from Cellular to Marine, and "MRN▶IP" is displayed while relaying from Marine to Cellular.

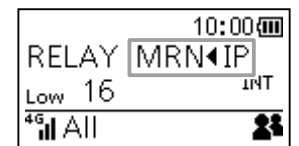

TIP:

- Push [16/Address] to turn the Relay function ON or OFF.
- "PAUSE" is displayed when:
 - The function is turned OFF.
 - A receive-only VHF marine channel is selected.

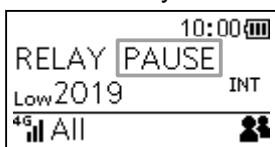

Section 6

SET MODE

- Using the Set mode6-2
 - ◇ Basic Set mode.....6-2
 - ◇ Detailed Set mode6-2
 - ◇ Using the Set mode6-2
- Set mode items.....6-3
 - ◇ Common6-3
 - ◇ Cellular.....6-5
 - ◇ Marine.....6-8
 - ◇ Cellular + Marine.....6-10

Using the Set mode

You can use a Set mode to set infrequently changed values or function settings. The transceiver has 2 types of Set modes, as shown below.

① You cannot transmit or receive while the transceiver is in a Set mode.

◇ Basic Set mode

1. Turn OFF the transceiver, if it is turned ON.
2. While holding down [FUNC], rotate [PWR/VOL] to turn ON the transceiver.
 - The Set mode is displayed.
 - ① Release [FUNC] when "SET" is displayed.
3. Rotate the Rotary Selector or push [▲] or [▼] to select an item group "Common," "Cellular," "Marine," or "Cellular + Marine," and then push [FUNC].
 - ① Select "Certification" and then push [FUNC] to display certification information.

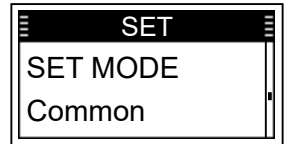

◇ Detailed Set mode

1. Turn OFF the transceiver, if it is turned ON.
2. While holding down [FUNC] and [16/Address], rotate [PWR/VOL] to turn ON the transceiver.
 - The Detailed Set mode is displayed.
 - ① Release [FUNC] and [16/Address] when "SET (Detail)" is displayed.
3. Rotate the Rotary Selector or push [▲] or [▼] to select an item group "Common," "Cellular," "Marine," or "Cellular + Marine," and then push [FUNC].

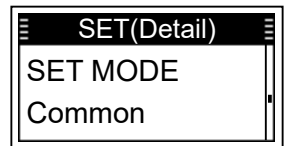

◇ Using the Set mode

Example: Disabling the key touch beep.

1. Turn OFF the transceiver, if it is turned ON.
2. While holding down [FUNC] and [16/Address], rotate [PWR/VOL] to turn ON the transceiver.
 - The Detailed Set mode is displayed.
 - ① Release [FUNC] and [16/Address] when "SET (Detail)" is displayed.
3. Rotate the Rotary Selector or push [▲] or [▼] to select an item group "Common," and then push [FUNC].
4. Push [FUNC] or [16/Address] several times to select "Key-Touch Beep."
5. Rotate the Rotary Selector or push [▲] or [▼] to select "OFF."
6. Push [CLR/Lock] to exit "Key-Touch Beep."
 - ① Push [CLR/Lock] again to exit the Set mode, and return to the Standby screen.

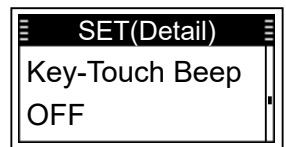

Set mode items

The shaded items are also displayed in the Basic Set mode.

① Items or default values may differ, depending on the transceiver's version or presets. Ask your dealer for details.

◇ Common

Item	Description	Option/range
RX Notify Vol.	Sets the call or message received notification volume.	0 ~ 32
Notify Vol.	Sets the Notification Beep level.	0 ~ 32
Key-Touch Beep	Selects whether or not to enable the Key-Touch beep.	OFF or ON
Key-Touch Beep Vol.	Sets the beep level when a transceiver's key is pushed.	0 ~ 32
Key-Touch Beep Linked	Selects whether or not to link the Key Touch Beep level to the transceiver's setting.	OFF or ON
Internal Mic Gain	Sets the internal microphone sensitivity. ① Higher values make the microphone more sensitive to your voice.	-12 dB ~ 12 dB (in 4 dB step)
External Mic Gain	Sets the external microphone sensitivity. ① Higher values make the microphone more sensitive to your voice.	-12 dB ~ 12 dB (in 4 dB step)
VOX	Selects whether or not to use the VOX function. The function automatically switches between receiving and transmitting by detecting your voice.	OFF, Bluetooth Mic*1, or Earphone Mic/ Headset
VOX Threshold*2	Sets the VOX gain level. ① Lower values make the VOX function more sensitive to your voice.	1 ~ 10
VOX Delay*2	Sets the period of time the transceiver continues transmitting after the user stops speaking, and then the VOX switches to receive. ① If you set the time too short, a pause in a conversation may be regarded as the end of the conversation, and the transceiver will start receiving, even as the conversation continues.	0.5 ~ 3.0
Noise Canceller	Selects whether or not to enable the Noise Cancelling function.	OFF or ON
PTT Lock	Selects whether or not to enable the PTT function. The function inhibits transmission by the internal PTT.	OFF or ON
Operate Inhibit	Selects whether or not to inhibit the operation except using [PWR/VOL].	OFF or ON
AF Min Level	Sets the minimum audio output level.	0 ~ 32
AF Max Level	Sets the maximum audio output level.	0 ~ 32
Backlight	Selects a Backlight option.	Auto, ON, or OFF
Brightness	Selects a Backlight brightness option.	Light or Dark
Contrast	Sets the screen contrast.	1 ~ 16
Bluetooth*1	Selects whether or not to enable the Bluetooth function. (p. 5-2)	OFF or ON
BT Auto Connect*1*3	Selects whether or not to automatically connect a Bluetooth device.	OFF or ON
BT Sync Vol.*1*3	Selects whether or not to synchronize the Bluetooth headset's volume level with the transceiver's volume level. ① When "ON" is selected, the Bluetooth headset volume can be set by rotating [PWR/VOL].	OFF or ON
BT Connect Type*1*3	Selects a Bluetooth headset's Synchronous Connection-Oriented (SCO) link* connection type. When "Auto Disconnect" is selected, the SCO link is automatically disconnected after 2 seconds. *A Bluetooth link for voice communication. ① This setting is valid only when a Bluetooth device other than a VS-3 is used. ② When this item is set to "Auto Disconnect," the VOX function is unusable.	Always Connect or Auto Disconnect

*1 For only the transceiver with the Bluetooth function.

*2 Displayed only when "Bluetooth Mic" or "Earphone Mic" is selected in the "VOX" item.

*3 Displayed only when "ON" is selected in the "Bluetooth" item.

6 SET MODE

Set mode items

The shaded items are also displayed in the Basic Set mode.

① Items or default values may differ, depending on the transceiver's version or presets. Ask your dealer for details.

◇ Common

Item	Description	Option/range
BT PTT & Mic Switch* ¹ * ³	Enables the user to select which microphone to use. ① When this item is set to "Auto," the transceiver transmits the audio from the device whose [PTT] is pushed.	Auto, Bluetooth Mic, or Radio Mic
BT AF Output* ¹ * ³	Selects the AF Output device when a Bluetooth headset is connected.	BT Only or BT & SP
BT Mic Gain* ¹ * ³	Sets the Bluetooth microphone sensitivity. ① Higher values make the microphone more sensitive to your voice.	-12 dB ~ 12 dB (in 4 dB step)
BT Echo Cancellor* ¹ * ³	Selects whether or not to enable the Bluetooth headset's Echo Cancellor.	OFF or ON
BT E-Cancel Gain* ¹ * ³	Sets the Echo Cancellor input gain for a Bluetooth headset.	-40 dB ~ 40 dB
BT E-Cancel Delay* ¹ * ³	Sets the Echo Cancellor delay for a Bluetooth headset.	0 milliseconds ~ 160 milliseconds
BT Noise Cancel* ¹ * ³	Selects whether or not to enable the Bluetooth headset's Noise Cancellor.	OFF or ON
BT Power Save* ¹ * ³	Selects whether or not to enable the Bluetooth headset's Power Save function. ① When "ON" is selected, the Power Save function automatically activates after 2 minutes of no communication.	OFF or ON
BT One Touch PTT* ¹ * ³	Selects whether or not to enable the One-Touch PTT function while a Bluetooth headset is connected. The function switches receiving and transmitting by momentarily pushing [PTT] on a Bluetooth headset. ① Push [PTT] to talk, and push again to return to receive. ① When "ON" is selected, you do not have to hold down [PTT] while talking.	OFF or ON
Show BT One Touch PTT* ¹ * ³	Selects whether or not to display the "BT One Touch PTT" item by pushing [FUNC] on the standby screen.	OFF or ON
BT PTT Beep* ¹ * ³	Selects whether or not to sound a beep when the [PTT] on the Bluetooth headset is pushed.	OFF or ON
Search BT Device* ¹ * ³	Searches for Bluetooth devices. ① Push [CH/Call History] to start searching.	Search
Delete BT Device* ¹ * ³	Deletes paired devices.	-
Init BT Unit* ¹ * ³	Initializes the built-in Bluetooth unit and pairing list.	-- -- or Clear
BT Unit Version* ¹	Displays the built-in Bluetooth unit version.	-
RESET	Resets the transceiver to its defaults, except for the Bluetooth pairing list. ① Select "Run," and then push [CH/Call History] to reset. ① The transceiver automatically restarts.	NO or YES

*¹ For only the transceiver with the Bluetooth function.

*³ Displayed only when "ON" is selected in the "Bluetooth" item.

Set mode items

The shaded items are also displayed in the Basic Set mode.

① Items or default values may differ, depending on the transceiver's version or presets. Ask your dealer for details.

◇ Cellular

Item	Description	Option/range
LOG CLEAR	Deletes logs. ① Select "Clear," and then push [CH/Call History] to delete.	---, Clear
FIRM UP	Updates the transceiver's firmware. ① Select "YES," and then push [CH/Call History] to update the firmware. ① The transceiver automatically restarts. ① Updating the firmware takes approximately 10 minutes.	NO or YES
Man Down*4	Selects whether or not to enable the Man Down function. The transceiver enters the Emergency mode when tilted past the preset angle for a set time. (p. 5-7)	OFF or ON
Lone Worker*4	Selects whether or not to enable the Lone Worker function. The transceiver enters the Emergency mode when no operation occurs for a set time. (p. 5-8)	OFF or ON
Stationary Detection*4	Selects whether or not to enable the Stationary Detection function. The transceiver enters the Emergency mode when detected as stationary (no motion) for a set time. (p. 5-9)	OFF or ON
Motion Detection*4	Selects whether or not to enable the Motion Detection function. The transceiver enters the Emergency mode when it continuously moves for a set time. (p. 5-9)	OFF or ON
Recording	Selects whether or not to enable the Voice Recorder function. (p. 5-10)	OFF or ON
Record Call type*5	Selects a type of call to record.	Individual Call or All
Delete Recording*5	Deletes recorded audio. ① Select "Clear," and then push [CH/Call History] to delete.	--- or Clear
Sub PTT Push*6	Sets the function to execute when pushing [Sub PTT].	Null, Message, or One Touch
Sub PTT Hold*6	Sets the function to execute when holding down [Sub PTT].	Null, Message, One Touch, or AquaQuake
Side 1 Push	Sets the function to execute when pushing [Side 1].	Null, Message, or One Touch
Side 1 Hold	Sets the function to execute when holding down [Side 1].	Null, Message, One Touch, or AquaQuake
Side 2 Push	Sets the function to execute when pushing [Side 2].	Null, Message, or One Touch
Side 2 Hold	Sets the function to execute when holding down [Side 2].	Null, Message, One Touch, or AquaQuake
Success Tone	Selects whether or not to enable the tone that indicates an individual call was successfully transmitted. ① The transmission result is also displayed on the screen.	OFF or ON
Failure Tone	Selects whether or not to enable the tone that indicates an individual call failed. ① The transmission result is also displayed on the screen.	OFF or ON

*4 Displayed only when the Emergency Call function is enabled by your dealer.

*5 Displayed only when "ON" is selected in the "Recording" item.

*6 In the Cellular + Marine mode, the transceiver transmits in the Sub mode regardless of the setting.

6 SET MODE

Set mode items

The shaded items are also displayed in the Basic Set mode.

① Items or default values may differ, depending on the transceiver's version or presets. Ask your dealer for details.

◇ Cellular

Item	Description	Option/range
Call Tone (IND/GRP/ALL/TEL)	Sets the call Initiation tone.	OFF, Tone1 ~ Tone8 ① A larger number makes the tone lower.
Crtsy Beep (IND/GRP/ALL/TEL)	Sets the call Termination beep.	OFF, Tone1 ~ Tone8 ① A larger number makes the tone lower.
RX Tone (IND/GRP/ALL/TEL/ MSG)	Sets the call Receive tone.	OFF, Tone1 ~ Tone8 ① A larger number makes the tone lower.
Notify Type (IND/GRP/ALL/TEL)	Sets the call to receive notification type.	P-Bell or Pocket beep
Notify No. (IND/GRP/ALL/TEL/ MSG)	Sets the number of tones.	Continuous (Except for "MSG"), 1, 3, 10, 20 (times)
RX Notify Actn.	Sets the call or message receive notification type.	Tone, Vibration, or Tone + Vibration
Out of Rng Tone	Selects whether or not to enable the Out-of-Area Warning Beep. The beep also sounds when the transceiver reenters the service area.	OFF or ON
Range Side Tone	Selects whether or not to mute the Side Tone when the transceiver is out-of-area.	OFF or ON
Sidetone	Selects whether or not to output your voice to a headset that is connected to the transceiver. ① The function outputs your voice even if you are not holding down [Main PTT], depending on the attached microphone. (p. 7-6)	OFF or ON
Sidetone Volume*7	Sets the Sidetone volume.	0 ~ 32
Echo Cancellor	Selects whether or not to enable the Echo Cancelling function. ① This function is commonly used for earphone microphones and headsets. ① This function is unusable when the "Sidetone" is set to "ON."	OFF or ON
RX Buffer Type	Sets the Jitter buffer size. ① A Jitter buffer reduces audio interruptions.	Dynamic, 40 milliseconds ~ 480 milliseconds (in 40 milliseconds step)
Call Type Stnby	Selects whether or not to display the call-to party (Call type)* on the standby screen. *Preset by your dealer.	OFF or ON
One Touch PTT	Selects whether or not to enable the One-Touch PTT function. The function switches receiving and transmitting by momentarily pushing [Main PTT]. ① Push [Main PTT] to talk, and push again to return to receive. ① When "ON" is selected, you do not have to hold down [Main PTT] while talking.	OFF or ON
Destination ID	Selects a Destination ID display option. ① If "OFF" is selected, the call-to party (call type) that is preset by your dealer is displayed on the standby screen.	OFF, All Operations, Transmit and Receive, or Transmit
Show SIM Selection	Selects whether or not to display the "SIM Selection" item by pushing [FUNC] on the standby screen.	OFF or ON

*7 Displayed only when "ON" is selected in the "Sidetone" item.

6 SET MODE

Set mode items

The shaded items are also displayed in the Basic Set mode.

① Items or default values may differ, depending on the transceiver's version or presets. Ask your dealer for details.

◇ Cellular

Item	Description	Option/range
SIM Selection	Selects a SIM card. (p. 4-7) ① Rotate the Rotary Selector or push [▲] or [▼] to select a SIM card, and then push [CH/Call History] to restart the transceiver.	__ __ * (SIM1) *A SIM card name is displayed, if it is named.
Show Network Select	Selects whether or not to display the "Network Select" item by pushing [FUNC] on the standby screen.	OFF or ON
Network Select	Selects whether or not to automatically select a network carrier.	Auto, Last accessed, or User select
Cellular Unit Version	Displays the internal cellular unit version.	—
IMEI	Displays the Communication unit IMEI number.	—
Phone Number* ⁸ * ⁹	Displays the SIM card's telephone number.	—
ICCID* ⁹	Displays the SIM card's ICCID.	—

*⁸ May not be displayed, depending on the inserted SIM card.

*⁹ Displays the phone number and ICCID of the SIM card selected in the "SIM Selection" item.

6 SET MODE

Set mode items

The shaded items are also displayed in the Basic Set mode.

① Items or default values may differ, depending on the transceiver's version or presets. Ask your dealer for details.

◇ Marine

Item	Description	Option/range
WX Alert	A NOAA broadcast station transmits a Weather Alert tone before any important weather information is broadcast.	OFF or ON
Priority Scan* ¹⁰	Selects whether or not to use Priority scan. ① When "OFF" is selected, a Normal scan will be performed.	OFF or ON
Scan Timer* ¹⁰	Selects whether or not to use the scan timer to pause, or to resume after 5 seconds, when a signal is detected.	OFF or ON
Auto Scan	Turns the Automatic Scan function ON or OFF.	OFF or ON
Dual/Tri-Watch* ¹⁰	Selects Dualwatch or Tri-Watch.	Dualwatch or Tri-Watch
Monitor Switch Action	Holding down the key that [Monitor] is assigned to for 1 second turns ON the monitor function and opens the squelch. Selects whether the squelch closes when you release the key or push any key.	Push or Hold
Show SQL Level Selection	Selects whether or not the SQL level selection screen can be selected by pushing [FUNC] several times in the Marine mode, Cellular + Marine mode, and Relay mode.	OFF or ON
Show Favorite Selection	Selects whether or not the Favorite screen can be selected by pushing [FUNC] several times in the Marine mode and Cellular + Marine mode.	OFF or ON
Channel Display (INT/USA/CAN/ATIS)	Selects the number of digits to display the channel number. ① This setting may not be usable, depending on the transceiver version or presetting.	3 digits or 4 digits
Call Channel (INT/USA/CAN/ATIS)	Sets your Call channel. The default setting may differ, depending on the transceiver version. ① This setting may not be usable, depending on the transceiver version or presetting.	Channels available for each channel group
Sub PTT Push* ⁶	Sets the function to execute when pushing [Sub PTT]. ① When "Marine PTT" is assigned to "Sub PTT Hold," this item cannot be set.	FAV Up, FAV ON/OFF, SQL Level, Scan, or Dualwatch/Tri-Watch
Sub PTT Hold* ⁶	Sets the function to execute when holding down [Sub PTT].	Marine PTT, Monitor, FAV Up, FAV ON/OFF, SQL Level, Scan, Dualwatch/Tri-Watch, or AquaQuake
Side1 Push	Sets the function to execute when pushing [Side 1].	FAV Up, FAV ON/OFF, SQL Level, Scan, or Dualwatch/Tri-Watch
Side1 Hold	Sets the function to execute when holding down [Side 1].	Monitor, FAV Up, FAV ON/OFF, SQL Level, Scan, Dualwatch/Tri-Watch, or AquaQuake
Side2 Push	Sets the function to execute when pushing [Side 2].	FAV Up, FAV ON/OFF, SQL Level, Scan, or Dualwatch/Tri-Watch

*⁶ In the Cellular + Marine mode, the transceiver transmits in the Sub mode regardless of the setting.

*¹⁰ Except for the NLD version.

Set mode items

The shaded items are also displayed in the Basic Set mode.

① Items or default values may differ, depending on the transceiver's version or presets. Ask your dealer for details.

◇ Marine

Item	Description	Option/range
Side2 Hold	Sets the function to execute when holding down [Side 2].	Monitor, FAV Up, FAV ON/OFF, SQL Level, Scan, Dualwatch/Tri-Watch, or AquaQuake
Model* ¹¹	Selects the country where you operate the transceiver.	General, UK, Netherlands, or Germany ① "General" means the EUR version.
Favorite Channel (INT/USA/CAN/ATIS)	Sets all channels as Favorite channels, clears all channel settings, or resets all channels to default. By default, some channels are preset. The Favorite channels may differ, depending on the transceiver version. ① This setting may not be usable, depending on the transceiver version or presetting.	Set All Channels, Clear All Channels, or Set Default

*¹¹ For only the European version.

6 SET MODE

Set mode items

- ① Items or default values may differ, depending on the transceiver's version or presets. Ask your dealer for details.
- ② The Cellular + Marine setting items can only be displayed in the Detailed Set mode.

◇ Cellular + Marine

Item	Description	Option/range
Call Tone (Cellular/Marine)	Sets the call Initiation tone.	Tone1 ~ Tone8 ① A larger number makes the tone lower.
Crtsy Beep (Cellular/Marine)	Sets the call Termination beep.	OFF, Tone1 ~ Tone8 ① A larger number makes the tone lower.
RX Tone (Cellular/Marine)	Sets the call Receive tone.	OFF, Tone1 ~ Tone8 ① A larger number makes the tone lower.
Notify No. (Cellular/Marine)	Sets the number of tones.	Continuous, 1, 3, 10, 20 (times)
Cellular Main* ¹²	Selects whether or not to enable Main to be set to Cellular mode and Sub to be set to the Marine mode in the Cellular + Marine mode.	OFF or ON
Marine Main* ¹²	Selects whether or not to enable Main to be set to Marine mode and Sub to be set to the Cellular mode in the Cellular + Marine mode.	OFF or ON
Adaptive PTT (Cellular Main)* ¹²	Selects whether or not to enable Main to be set to Cellular mode and Sub to be set to the Marine mode in the Adaptive PTT mode.	OFF or ON
Adaptive PTT (Marine Main)* ¹²	Selects whether or not to enable Main to be set to Marine mode and Sub to be set to the Cellular mode in the Adaptive PTT mode.	OFF or ON

*¹² When 3 of the 4 items are set to "OFF," the remaining 1 item will be fixed to "ON."

Section 7 FOR YOUR REFERENCE

Specifications	7-2
◇ General	7-2
◇ 4G (LTE)/3G (W-CDMA)	7-2
◇ Transmitter	7-3
◇ Receiver	7-3
◇ Bluetooth	7-4
Options	7-5
◇ Battery pack	7-5
◇ Chargers	7-5
◇ Others	7-5
◇ About the Sidetone function and headset	7-6
◇ Using the BC-227 DESKTOP CHARGER	7-6
◇ Using the BC-226 DESKTOP CHARGER	7-7
◇ Using the LC-195 CARRYING CASE	7-8
◇ Using the HM-238MC TIEPIN TYPE MICROPHONE with a [Sub PTT] switch	7-9
Troubleshooting	7-10

Specifications

- ① Measurements made without an antenna.
- ① All stated specifications are subject to change without notice or obligation.

◇ General

- Frequency band (For Marine):

USA version	TX 156.025 MHz ~ 157.425 MHz
	RX 156.050 MHz ~ 163.275 MHz
EUR version	TX 156.000 MHz ~ 161.450 MHz
	RX 156.000 MHz ~ 163.425 MHz
AUS version	TX 156.025 MHz ~ 157.425 MHz
	RX 156.300 MHz ~ 162.000 MHz
- Type of emission: 16K0G3E
- Antenna impedance: 50 Ω nominal
- Input impedance (MIC): 2.2 k Ω
- Output impedance (audio): 8 Ω (Internal speaker/External speaker)
- Operating temperature range:

USA version	–20°C ~ +60°C (–4°F ~ +140°F)
EUR version	–15°C ~ +55°C (5°F ~ +131°F)
AUS version	–10°C ~ +55°C (14°F ~ +131°F)
- Power supply voltage: 7.4 V DC nominal (Negative ground)
- Current drain (approximate):

RX stand-by	0.3 A
Receive Maximum audio	0.52 A (Internal speaker)
TX High (5 W)	1.6 A
- Dimensions: 53.7 (W) × 121.7 (H) × 36.6 (D) mm (with BP-303)
(projections not included) 2.1 (W) × 4.8 (H) × 1.4 (D) in
- Weight (approximate): 320 g, 11.3 oz (with BP-303)

◇ 4G (LTE)/3G (W-CDMA)

- Frequency band:

USA version	LTE B2, B4, B12
	W-CDMA B2, B5
EUR version	LTE B1, B3, B7, B8, B20
	W-CDMA B1, B8
AUS version	LTE B1, B3, B5, B7, B8, B28
	W-CDMA B1, B5
- Modulation: QPSK, 16QAM, 64QAM
- Rated output power: 0.25 W
- Receiver sensitivity (QPSK): Less than –95 dBm at 5% BLER

Specifications

◇ Transmitter

- Rated output power: 5 W or 1 W
- SAR 10g (W/kg):
 EUR version 1.96
- Modulation: Variable reactance frequency modulation
- Maximum frequency deviation: ±5 kHz
- Frequency error:
 USA version ±10 ppm
 EUR version ±1.5 kHz
 AUS version ±10 ppm
- Spurious emissions:
 USA version -68 dBc (typical)
 EUR version Less than 0.25 µW
 AUS version 0.25 µW (typical)
- Adjacent channel power: More than 70 dB
- Audio harmonic distortion:
 (at 60% Deviation) Less than 10%
- Residual modulation: More than 40 dB
- Audio frequency response: +1 dB ~ -3 dB of 6 dB octave from 300 Hz ~ 3000 Hz

◇ Receiver

- Sensitivity (typical):
 USA version 0.25 µV at 12 dB SINAD
 EUR version -3 dBµ emf at 20 dB SINAD
 AUS version -3 dBµ emf at 20 dB SINAD
- Squelch sensitivity:
 (threshold, typical)
 USA version 0.25 µV
 EUR version -3 dBµ emf
 AUS version -3 dBµ emf
- Audio power output:
 (at 10% distortion into an 8 Ω load at 1 kHz)
 Internal speaker 1.5 W (typical)
 External speaker 1.0 W (typical)
 HM-222H 1.5 W (typical)
- Adjacent channel selectivity:
 USA version 70 dB (typical)
 EUR version More than 70 dB
 AUS version More than 65 dB
- Spurious response:
 USA version 70 dB (typical)
 EUR version More than 70 dB
 AUS version More than 65 dB
- Intermodulation:
 USA version 70 dB (typical)
 EUR version More than 68 dB
 AUS version More than 65 dB
- Hum and Noise: More than 40 dB
- Audio frequency response: +1 dB ~ -3 dB of -6 dB octave from 300 Hz ~ 3000 Hz

Specifications

◇ **Bluetooth**

USA/EUR/AUS

- Version: 5.3
- Output power: Class 1
- Profile: HFP, HSP
- Modulation: GFSK, $\pi/4$ -DQPSK, 8DPSK

Options

◇ Battery pack

- **BP-303** Li-ion BATTERY PACK

Voltage: 7.2 V

Capacity: 3200 mAh (minimum), 3350 mAh (typical)

Battery life: Approximately 24 hours* (Cellular mode)

Approximately 13 hours* (Marine mode)

* Calculated under the following conditions:

- Bluetooth and Backlight are OFF

- TX : RX : standby = 5 : 5 : 90

The operating time may be shorter, depending on:

- The operating conditions, such as Bluetooth, GPS, operating mode, and so on.

- The distance from the cellular station or the signal strength.

◇ Chargers

- **BC-227** DESKTOP CHARGER + **BC-123S** AC ADAPTER

Charging time: Approximately 4.4 hours

- **BC-226** DESKTOP CHARGER + **BC-228** AC ADAPTER

You can connect up to 6 BC-226 together.

Charging time: Approximately 4.2 hours

① A power adapter may be supplied, depending on the charger's version.

- **BC-214N** MULTI CHARGER + **AD-132N** CHARGER ADAPTER + **BC-157S** AC ADAPTER

To rapidly charge up to 6 battery packs.

◇ Others

- **FA-S59V** FLEXIBLE ANTENNA

- **MB-136, MB-133** BELT CLIP

- **MB-96F, MB-96FL, MB-96N** BELT HANGER

- **LC-195** CARRYING CASE

- **VS-3** Bluetooth® HEADSET

The Bluetooth headset with a [PTT] switch.

- **VS-5MC*** PTT SWITCH CABLE

+ **HS-94, HS-95, HS-97** HEADSET

VS-5MC: Used to connect a headset to a transceiver.

HS-94: Ear-hook type

HS-95: Neck-arm type

HS-97: Throat microphone

* Non-waterproof

- **HM-184H, HM-222H** SPEAKER MICROPHONE

HM-184H: Meets IP67 dust-tight and waterproof protection.

HM-222H: Meets IP68 dust-tight and waterproof protection, high audio output type.

- **HM-238MC** TIEPIN TYPE MICROPHONE

With a [Sub PTT] switch.

- **EH-15B** EARPHONE,

SP-26 TUBE EARPHONE,

SP-28 EAR HOOK TYPE EARPHONE

For use with the HM-238MC.

- **SP-27** TUBE EARPHONE,

SP-29 EAR HOOK TYPE EARPHONE,

SP-40 EARPHONE

For use with the HM-222H.

Options

◇ **About the Sidetone function and headset**

The Sidetone function (p. 6-6) works differ, depending on the connected microphone, as shown below.

- ① Usable options may be added in the future. Ask your dealer for details of how they work.

When the HM-238MC or VS-5MC is attached:

The transceiver always outputs your voice to a headset.

When the HM-184H or HM-222H is attached:

The transceiver outputs your voice to a headset while holding down [PTT].

◇ **Using the BC-227 DESKTOP CHARGER**

Charging time: approximately 4.4 hours for the BP-303.

CAUTION: Before using the charger, read the 'Battery caution' and 'Charging caution' on the boxed Instruction manual with the transceiver.

○ **Status indicator**

Light color	Status
Orange	Charging.
Green	Charging is completed.
Blinks orange and green	Charging failed. It may have some problems.

NOTE:

- Before using the transceiver for the first time, the battery pack must be fully charged for optimum life and operation. To avoid damage to the transceiver, turn OFF the transceiver before charging. Otherwise:
 - The battery will not be charged properly.
 - The battery life may be shortened.
- **DO NOT** transmit while charging. If you need to transmit, remove the transceiver from the charger, and then turn ON the transceiver.
- If the battery pack does not properly charge, remove the transceiver from the charger and insert the transceiver into the charger again.

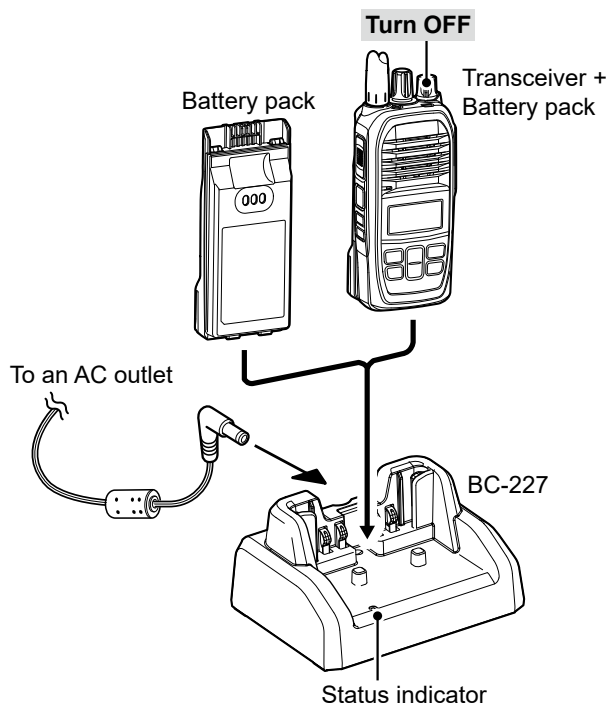

NOTE: Be sure the tabs on the battery pack are correctly aligned with the guide rails inside the battery charger.

Options

◇ Using the BC-226 DESKTOP CHARGER

Charging time: approximately 4.2 hours for the BP-303.

CAUTION: Before using the charger, read the 'Battery caution' and 'Charging caution' on the boxed Instruction manual with the transceiver.

○ Status indicator

Light color	Status
Orange	Charging.
Green	Charging is completed.
Blinks orange and green	Charging failed. It may have some problems.

NOTE:

- Before using the transceiver for the first time, the battery pack must be fully charged for optimum life and operation. To avoid damage to the transceiver, turn OFF the transceiver before charging. Otherwise:
 - The battery will not be charged properly.
 - The battery life may be shortened.
- **DO NOT** transmit while charging. If you need to transmit, remove the transceiver from the charger, and then turn ON the transceiver.
- If the battery pack does not properly charge, remove the transceiver from the charger and insert the transceiver into the charger again.

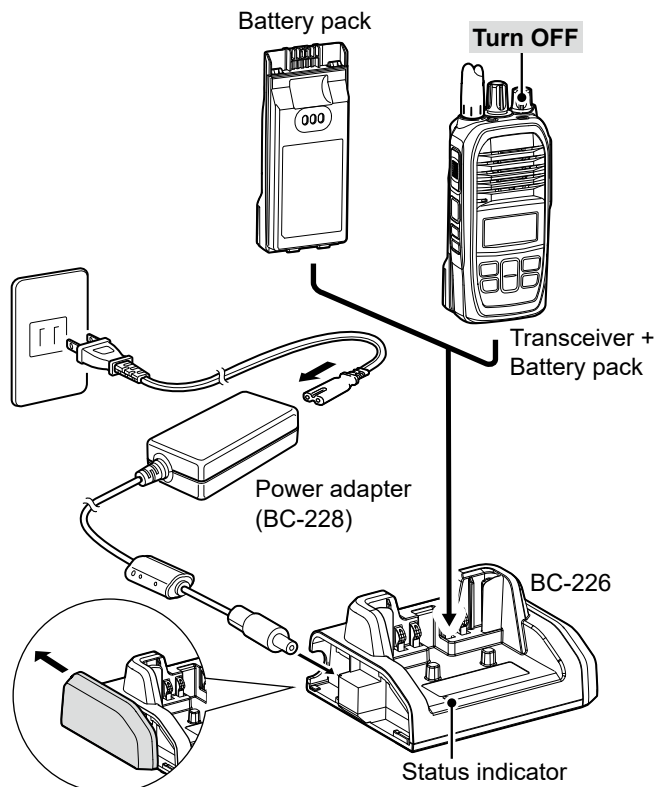

NOTE: Be sure the tabs on the battery pack are correctly aligned with the guide rails inside the battery charger.

○ Connecting the BC-226 together

You can connect up to 6 BC-226 together.

1. Remove the charger's right cover. (1)
2. Snap the DC power plug to the another charger's DC power jack. (2)

⚠ WARNING! NEVER connect more than 6 chargers together. It may result in an electric shock, cause a fire, overheating, or damage the chargers and AC adapter.

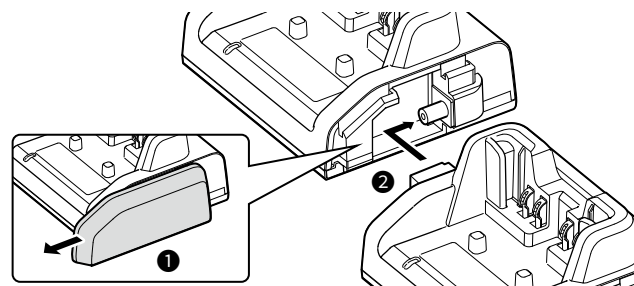

○ Fuse replacement

If a fuse blows, find and repair the cause of the problem. Then replace the damaged fuse with a new, adequately rated fuse.

Fuse type: 5 A/58 V (low profile mini blade fuse)

NOTE: Remove the fuse using needle-nose pliers.

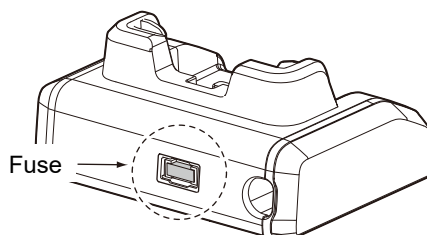

Options

◇ Using the LC-195 CARRYING CASE

The LC-195 is a leather case usable when the battery pack is attached. Adjust the fixing position with the hook-and-loop fasteners.

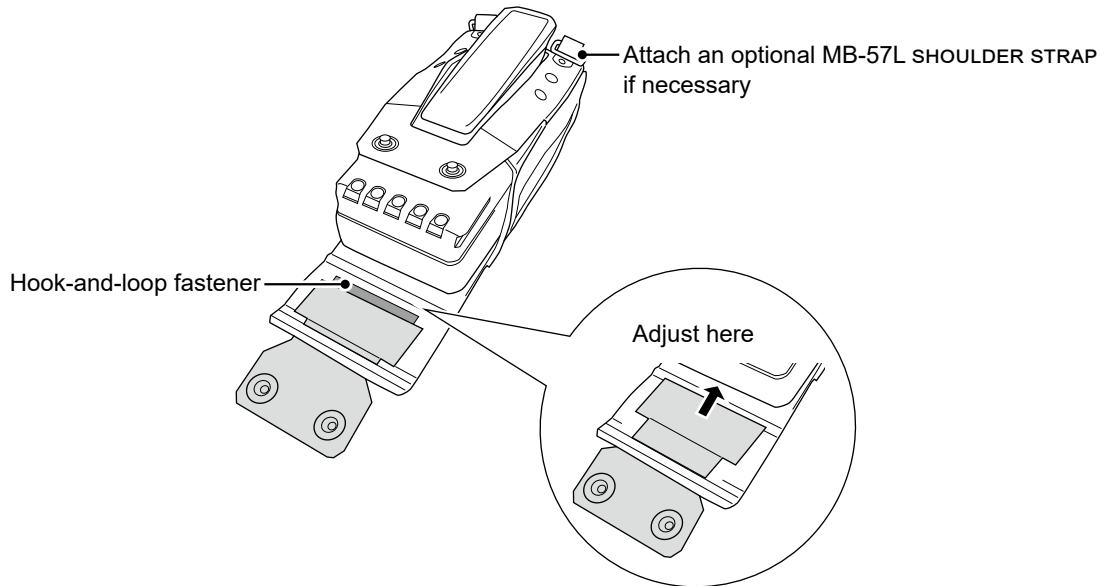

You can charge even when the leather case is attached, as shown below.

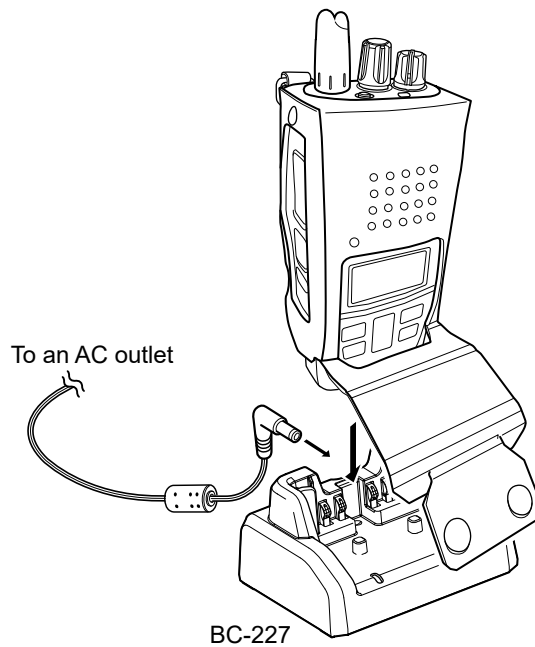

Options

◇ Using the HM-238MC TIEPIN TYPE MICROPHONE with a [Sub PTT] switch

The HM-238MC is a Tie-clip type microphone that can operate the [Main PTT], [Sub PTT], and [Side 1] switches of the transceiver.

NOTE: When the HM-238MC is attached to the transceiver, no audio is output from the transceiver's speaker.
BE SURE to connect the EH-15B, SP-26, or SP-28 earphones to the HM-238MC before use.

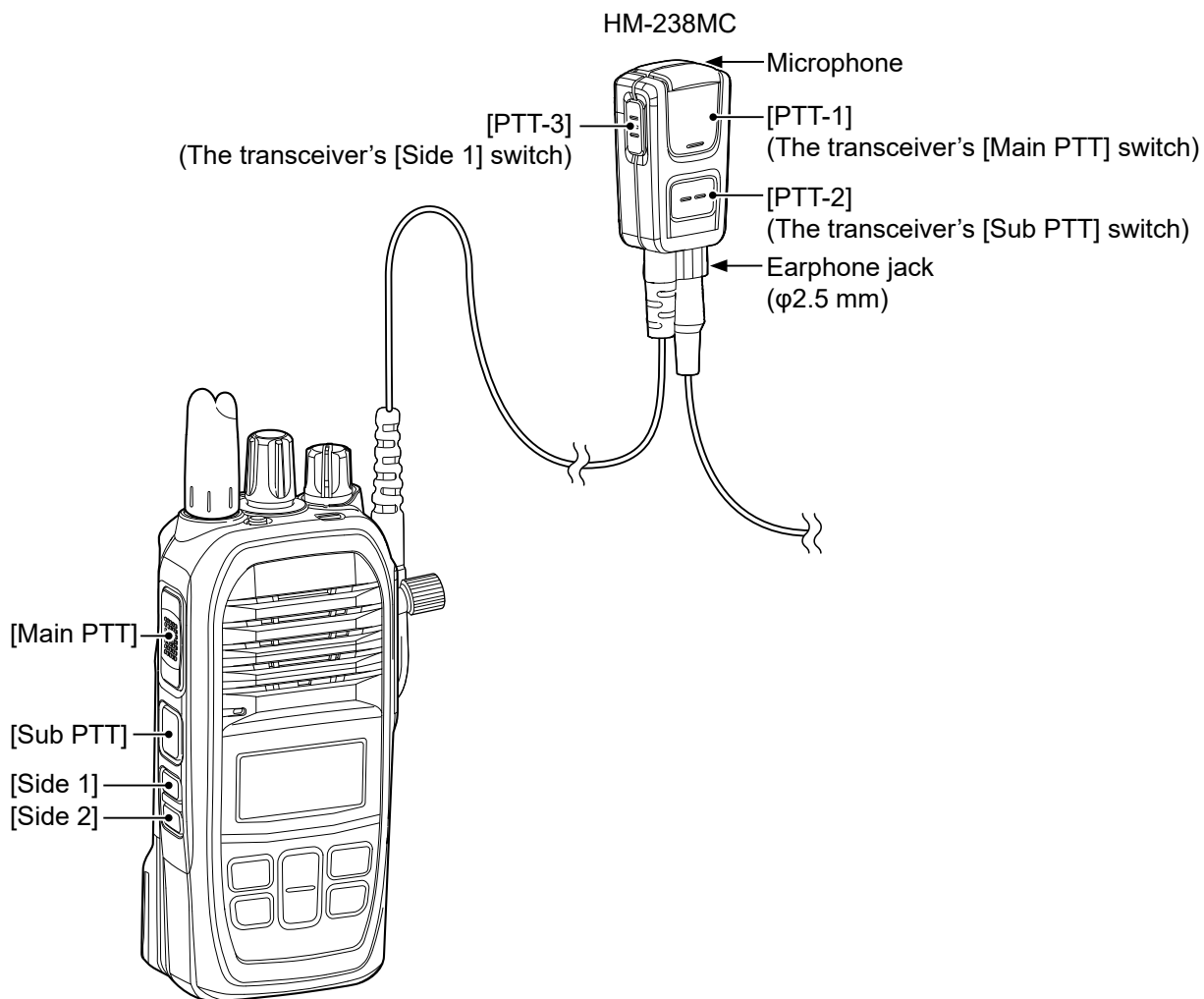

Troubleshooting

The following conditions are not due to a malfunction. Check before sending a request for repair.

The transceiver does not turn ON.

- The battery is exhausted or over discharged.
 - Recharge the battery pack.
- The battery pack is not correctly attached.
 - Correctly reattach the battery pack. (p. 1-3)
- The battery pack's over-discharge protection circuitry is activated.
 - Remove the battery pack from the transceiver, then charge it for a while.
 - Attach the battery pack to the transceiver again, then turn ON the transceiver.
- Loose connection of the battery pack.
 - Clean the battery pack terminals.

No sound comes from the speaker, earphone, or headset.

- The squelch level is set too high.
 - Set the squelch level to the threshold point.
- The volume level is set too low.
 - Set the volume level to a suitable level.
- The internal speaker has been exposed to water.
 - Use the AquaQuake Water Draining function to remove water from the speaker grill. (p. 3-3)
- Loose earphone plug connection.
 - Firmly insert the plug.

No beep sounds.

- The Key-Touch Beep function is OFF.
 - Turn ON the Key-Touch Beep function. (p. 6-3)
- The Key Beep Volume level is set too low.
 - Set the volume to a suitable level in the Set mode. (p. 6-3)

“Key lock” is displayed when you push any keys.

- The keypad is locked.
 - Hold down [CLR/Lock] for 1 second to unlock the keypad. (p. 3-2)

Calls cannot be made.

- The call-to party number or group number needs to be corrected.
 - Check the call-to party number or group number. (p. 4-2)

The “4G” blinks, or “Connecting...” is displayed. (The Standby screen is not displayed.)

- The transceiver is located out of the service area.
 - Move your location.
 - Restart the transceiver.

No reply is received.

- The transceiver is located out of the service area. (“4G” blinks.)
 - Move your location, and then try again.
- The transceiver is not registered to the system. (“4G” is displayed.)
 - Push [Main PTT] to re-register the transceiver to the system.
 - Wait for a while, or change your location.
 - Check that the Cellular line is established.
- The operator is away from the transceiver, or the transceiver is turned OFF.
 - Wait until the operator is back, or ask your system manager.

Troubleshooting

The charging indicator blinks orange or alternately blinks orange and green.

- The battery pack is not correctly attached.
 - Correctly reattach the battery pack. (p. 1-3)
- Charging the battery pack outside of the chargeable temperature range.
 - Charge the battery pack in the chargeable temperature range (15°C ~ 40°C (59°F ~ 104°F)).
- Loose connection of charging transceivers.
 - Clean the charger terminals.
- The transceiver power is ON while charging.
 - Turn OFF the power while charging. (p. 3-2)

The charging indicator is OFF even when the battery pack is inserted into the charger.

- The battery pack is not correctly attached.
 - Correctly reattach the battery pack. (p. 1-3)

The deleted recorded audio still exists, or the recorded audio is lost.

- The battery pack was removed before the recorded audio was deleted/saved from/to memory.
 - Remove the battery pack after "Power OFF..." is displayed. (p. 1-3)

Fails to pair your Bluetooth headset.

- The Bluetooth headset is not in the Pairing mode.
 - Confirm the Bluetooth headset is in the Pairing mode, and then try again. (p. 5-2)
- There are other active Bluetooth devices nearby.
 - Stop using other Bluetooth devices.
 - Use the transceiver away from other Bluetooth devices.
- Other devices are operating in the 2.4 GHz band.
 - Use the transceiver away from the other devices, or stop using those devices.

"Pairing list is full" is displayed on the Pairing screen.

- The number of paired devices exceeds the maximum number possible.
 - Delete a Bluetooth device from the pairing list. (p. 5-4)

The call was suddenly cut off. / Noise was heard.

- Too far from the Bluetooth device (When using a Bluetooth headset).
 - Get closer to the Bluetooth device.
 - ① The communication range of Bluetooth is approximately 10 meters (33 feet).
- Electromagnetic interference from other electronic devices is occurring.
 - Use the transceiver away from the other devices, or stop using those devices.

