



## INSTRUCTION MANUAL

---

HYBRID IP TRANSCEIVER  
**IP730D**  
**IP740D**

---

---

---

---

---

---

---

---

---

---

### INTRODUCTION

1 ACCESSORIES

2 BEFORE USING

3 USING THE CELLULAR MODE

4 USING THE IDAS MODE

5 OTHER FUNCTIONS

6 SET MODE

7 FOR YOUR REFERENCE

---

## INTRODUCTION

Thank you for choosing this Icom product. This product is designed and built with Icom's state of the art technology and craftsmanship. With proper care, this product should provide you with years of trouble-free operation.

---

## IMPORTANT

---

**FIRST, CAREFULLY READ INSTRUCTIONS** that is boxed with the transceiver.

**SAVE THIS INSTRUCTION MANUAL—** This instruction manual contains additional important operating instructions for the transceiver.

Icom, Icom Inc. and Icom logo are registered trademarks of Icom Incorporated (Japan) in Japan, the United States, the United Kingdom, Germany, France, Spain, Russia, Australia, New Zealand, and/or other countries.

The Bluetooth® word mark and logos are registered trademarks owned by Bluetooth SIG, Inc. and any use of such marks by Icom Inc. is under license.

AquaQuake™ is a trademark of Icom Incorporated.

All other products or brands are registered trademarks or trademarks of their respective holders.

Icom is not responsible for the destruction, damage to, or performance of any Icom or non-Icom equipment, if the malfunction is because of:

- Force majeure, including, but not limited to, fires, earthquakes, storms, floods, lightning, other natural disasters, disturbances, riots, war, or radioactive contamination.
- The use of Icom transceivers with any equipment that is not manufactured or approved by Icom.

# Section 1 ACCESSORIES

---

Supplied accessories.....	1-2
Attachable accessories.....	1-2
◇ Antenna .....	1-2
◇ Battery pack/Battery case.....	1-3
◇ Belt clip .....	1-3

## Supplied accessories

Battery pack

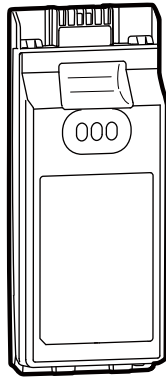

Belt clip



Connector cover and screw

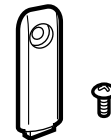

**NOTE:** Some accessories are not supplied, or the shape is different, depending on the transceiver version.

## Attachable accessories

### ◇ Antenna

Connect an optional antenna to the antenna connector.

**CAUTION:**

- **DO NOT** carry the transceiver by holding only the antenna.
- **DO NOT** connect an antenna other than the supplied antenna, or those listed in this manual.
- **DO NOT** transmit without an antenna.

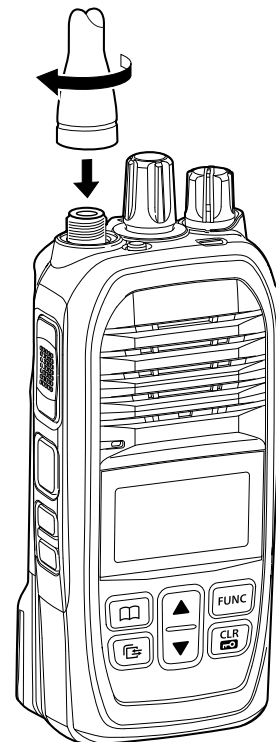

Attachable accessories (Continued)

◇ Battery pack/Battery case

**CAUTION:**

• **DO NOT** attach or detach the battery pack or the battery case when the transceiver is wet or soiled. This may result in water or dust getting into the transceiver, battery pack, or battery case and may damage them.

**CAUTION:** Keep the battery pack terminals clean. It's a good idea to occasionally clean them.

**To attach:**

1. Slide the battery pack in the direction of the arrow. (1)
2. Push the battery pack until the battery sliding locks make a 'click' sound. (2)

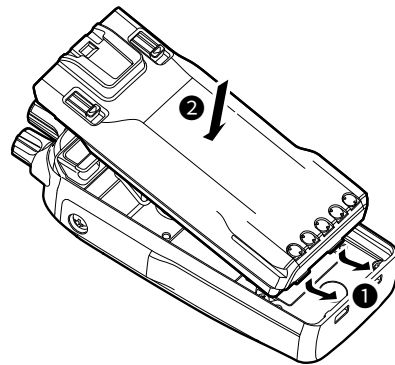

**To detach:**

1. Pull both battery sliding locks in the direction of the arrow. (1)
2. Lift up to detach the battery pack. (2)

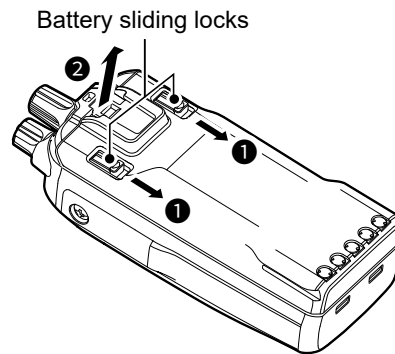

◇ Belt clip

**To attach:**

1. Remove the battery pack from the transceiver, if it is attached.
2. Slide the belt clip in the direction of the arrow until the belt clip is locked and makes a 'click' sound.

**To detach:**

1. Remove the battery pack from the transceiver, if it is attached.
2. Lift the tab up (1), and slide the belt clip in the direction of the arrow (2).  
ⓘ Be careful not to break your fingernail.

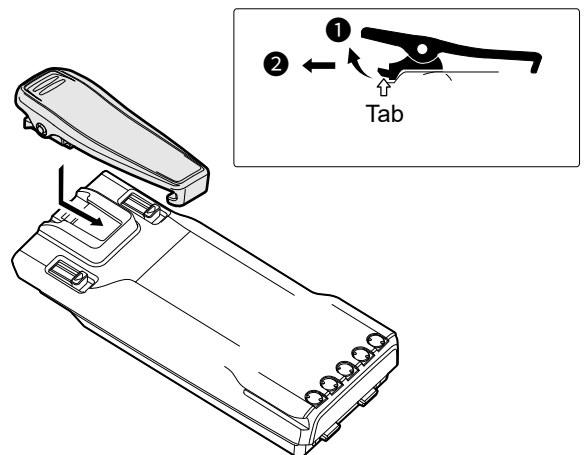

## Section 2

## BEFORE USING

---

Panel description .....	2-2
◇ Front, top and side panels .....	2-2
◇ Status indicator .....	2-2
◇ Multi-connector .....	2-2
◇ About the assignable key functions .....	2-2
Function display.....	2-3
◇ Cellular mode.....	2-3
◇ IDAS mode .....	2-3
◇ Cellular/IDAS mode .....	2-3
Basic operation.....	2-4
◇ Turning ON the transceiver .....	2-4
◇ Adjusting the volume level .....	2-4
◇ Using the Key Lock function .....	2-4
◇ Selecting the operation mode .....	2-4

## Panel description

### ◇ Front, top and side panels

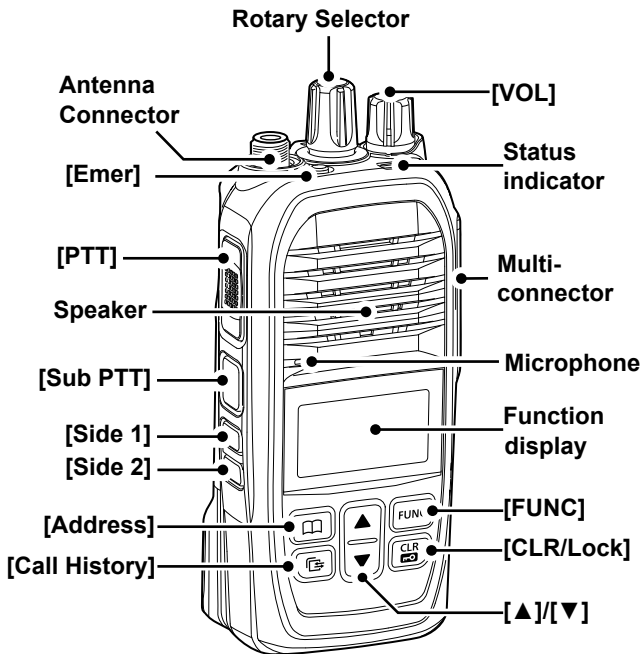

### ◇ Status indicator

- Lights red: Transmitting.
- Lights green: Receiving or squelch is open.
- Lights yellow: Receiving and transmitting in the Full-Duplex mode.

### ◇ Multi-connector

Connects to an optional speaker microphone or headset.

- ① Turn OFF the transceiver before attaching or detaching the microphone.

**CAUTION: DO NOT** use the transceiver without the connector cover or optional equipment attached. The transceiver meets IP67 requirements for dust-tight and waterproof protection only when the connector cover or the optional speaker microphone is attached. See page 7-4 for the usable speaker microphones.

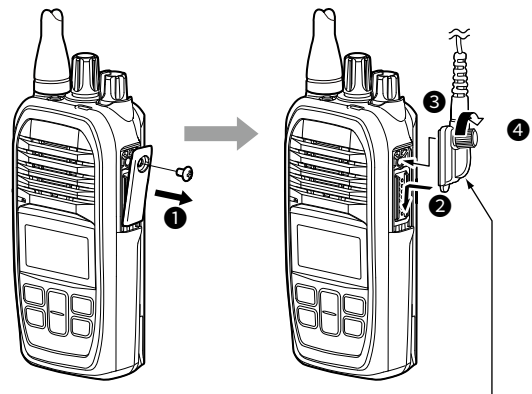

**CAUTION:** Firmly attach to the Multi connector, but do not overtighten. A loose connection will allow water intrusion into the connector. Over-tightening the connection can damage the transceiver.

### ◇ About the assignable key functions

Functions described on page 5-10 may be assigned to the [Sub PTT], [Side 1], and [Side 2] keys, depending on a presetting. Hold down or push these keys to use the assigned functions.

You can also assign the functions in the Detailed Set mode (p. 6-5).

## Function display



Cellular mode

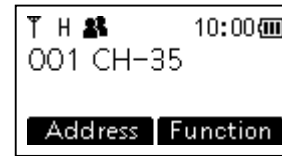

IDAS mode

### ◇ Cellular mode

	Displays the signal strength level by 3 bars. ① The connected network type (4G or 3G) is displayed on the left top.
	<ul style="list-style-type: none"> <li>Blinks when the transceiver location is out of the service area, or cannot receive a control signal.</li> <li>Displayed if the transceiver has not been authenticated.</li> </ul> ① The connected network type (4G or 3G) is displayed on the left top.
	All/Group Call
	Talkgroup Call* <sup>1</sup>
	Individual Call
	Phone Call* <sup>1</sup>
	<ul style="list-style-type: none"> <li>Displayed when the Pocket Beep function is ON. (p. 3-8)</li> <li>Blinks when a call is received. It blinks until the transceiver returns to the standby mode after a received signal disappears.</li> </ul>
	Displayed when the P-Bell function is ON. (p. 3-8)

### ◇ IDAS mode

	Displays the relative receive signal strength level.
	Displayed when the signal level is low.
	All/Group Call
	Individual Call
	Displayed when the Encryption function is ON. (p. 4-4)
	Displayed* <sup>2</sup> when high output power is selected.
	Displayed* <sup>2</sup> when low output power is selected. ① "L2" is displayed for 2 W, "L1" is displayed for 1 W.
	Displayed* <sup>2</sup> when a receive-only channel is selected.
	Displayed when the channel is in the audible (unmuted) mode.

### ◇ Cellular/IDAS mode

	<ul style="list-style-type: none"> <li>Displayed when the Record function is ON. (p. 5-9)</li> <li>Blinks while recording audio.</li> </ul>
	Displayed when Bluetooth is activated. (p. 5-2)
	Displayed when a Bluetooth device is connected. (p. 5-2)
	Displayed when the Key Lock function is ON. (p. 2-4)
	Displayed when the VOX function is ON. (p. 6-3)
	Displayed when the Emergency Call function is ON. (p. 5-5)
	Displays the remaining battery charge. ■■■ : Full ■■ : Mid ■ : Charging required □ : Battery exhausted
	Blinks when the transceiver is downloading a new firmware.
	Displayed when the Surveillance function is ON. (p. 5-10)

\*<sup>1</sup> May be usable, depending on a presetting.

\*<sup>2</sup> Blinks when the transceiver temperature becomes hot.



## Basic operation

### ◇ Turning ON the transceiver

**NOTE:** Before using the transceiver for the first time, the battery pack must be fully charged for optimum life and operation. See the BATTERY CHARGING section on the boxed INSTRUCTIONS.

- Rotate [VOL] clockwise to the 12 o'clock position to turn ON the transceiver.
  - ① The dial is made tight for dust and water resistance.
  - ① To turn OFF the transceiver, rotate [VOL] counter-clockwise until it makes a "click" sound.
  - ① An opening text may be displayed, depending on a presetting.

### ◇ Adjusting the volume level

- Rotate [VOL] to adjust the volume level.
  - ① The Adjustment screen is displayed while adjusting.

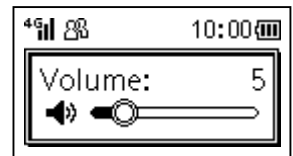

### ◇ Using the Key Lock function

You can use the Key Lock function to prevent accidental channel changes and unnecessary function access, depending on a presetting.

Functions except the following are electronically locked: [PTT], [Sub PTT], [VOL], [Emer], and the Monitor function.

- Hold down [CLR/Lock] for 1 second to turn the Key Lock function ON or OFF.
  - ① "LK" is displayed while the function is ON.

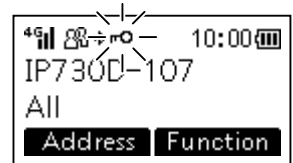

### ◇ Selecting the operation mode

You can select the operating mode, as shown below. See the section or page shown below for instructions on each operation mode.

**Cellular mode: Section 3**

**IDAS mode: Section 4**

**Dual mode: p. 5-11**

**NOTE: About the Repeater (Bridge) mode:**

The Repeater Mode relays received IDAS audio to the cellular transceiver group, while transferring the cellular radio conversations to the IDAS transceiver group. Ask your dealer about the mode details.

1. Push [FUNC] to display the function.
  - The Function screen is displayed.
2. Push [FUNC] to display "Mode Select," if another function is displayed.
  - ① You may need to push [FUNC] several times, depending on a presetting.
3. Push [▲] or [▼] to select the operating mode, and then push [Call History].
  - The operating mode is selected and then returns to the Standby screen.

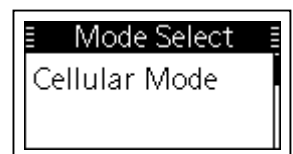

## Section 3

## USING THE CELLULAR MODE

---

Basic operation .....	3-2
◇ Operating keys.....	3-2
◇ Receiving and Transmitting .....	3-3
Advanced operation.....	3-4
◇ About the Talkgroup Call.....	3-4
◇ Selecting a Talkgroup number .....	3-5
◇ Sending a message (Message Call).....	3-6
◇ Browsing received messages .....	3-7
◇ Status Call .....	3-7
◇ Toggling the SIM card .....	3-8
◇ Pocket Beep function.....	3-8
◇ P-Bell function.....	3-8

## Basic operation

### ◇ Operating keys

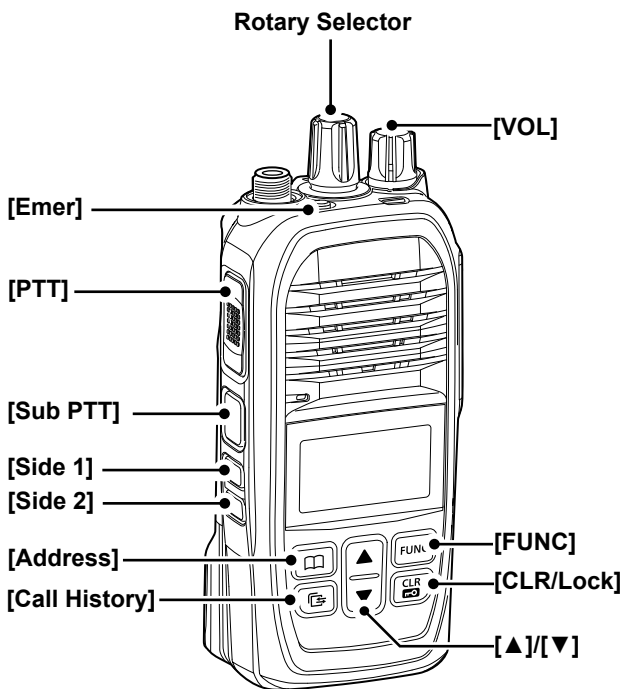

<b>Rotary Selector</b>	Rotate to select a channel, scroll the screen, or move the cursor.
<b>[Emer]</b>	Hold down until “Emergency” is displayed to send an Emergency call. (p. 5-5)
<b>[PTT]</b>	Hold down to transmit, release to receive.
<b>[Sub PTT] [Side 1] [Side 2]</b>	Functions may be assigned, depending on a presetting. See page 5-10 for assignable function details. You can also assign functions in the Detailed Set mode (p. 6-5).
<b>[Address]</b>	<ul style="list-style-type: none"> <li>• Selects a preset address. (p. 3-3)</li> <li>• Push to toggle the Address Book between the call types.</li> </ul>
<b>[Call History]</b>	<ul style="list-style-type: none"> <li>• Push to display the call history. (p. 3-6)</li> <li>• Push this key several times to toggle between the Call history types, Transmitted call, Received call, Sent message, Received message, Recording log, and Phone call log.</li> <li>• Hold down for 1 second to playback a selected Recording log. (p. 5-9)</li> </ul>
<b>[▲]/[▼]</b>	Push to scroll the screen, move the cursor, or selecting a channel.
<b>[CLR/Lock]</b>	<ul style="list-style-type: none"> <li>• Push to return to the standby screen.</li> <li>• Hold down for 1 second to turn the Key Lock function ON or OFF. (p. 2-4)</li> </ul> <p>① [PTT], [Sub PTT], [VOL], [Emer], and the Monitor function are usable even while the Key Lock function is ON.</p>
<b>[FUNC]</b>	<ul style="list-style-type: none"> <li>• Push to display the Function screen.</li> <li>• In the function screen, push several times to select functions such as Operating mode selection, Talkgroup Selection, and so on*.</li> </ul> <p>*Selectable function may differ, depending on a Set mode setting.</p>
<b>[VOL]</b>	<ul style="list-style-type: none"> <li>• Rotate to turn the transceiver ON or OFF.</li> <li>• Rotate to adjust the audio output level.</li> </ul>

### Basic operation (Continued)

#### ◇ Selecting a call-to party

1. Push [Address] to display the Address book.
  - ① The Address book is displayed.
2. Push [Address] several times to toggle the call type.
  - ① The selectable call type may differ, depending on a presetting.
3. Rotate Rotary Selector or push [▲] or [▼] to select a call-to party.

#### ◇ Receiving and transmitting

##### Receiving:

- When a Call is received, the Status indicator lights green.

##### Transmitting:

- While holding down [PTT], speak at your normal voice level.
  - ① The Status indicator lights red while [PTT] is pushed.

##### Talk while receiving a call:

- While receiving a call, push [PTT] to talk in the Full-Duplex mode\* like a telephone call.
  - ① In the Full-Duplex mode, the Status indicator lights yellow.

\* Usability depends on a presetting. Ask your dealer for details.

#### **IMPORTANT:**

To maximize the readability of your signal:

1. After pushing [PTT], pause briefly before you start speaking.
2. Hold the microphone 5 ~ 10 cm (2 ~ 4 inches) from your mouth, then speak at your normal voice level.

#### About the call type:

- All call: Transmit to all of the transceivers that belong to the network.
- Group call: Transmit to the transceivers that belong to the same group.
- Talkgroup call: Transmit to the transceivers that belong to the same Talkgroup.
- Individual call: Transmit to an individual transceiver.
- Telephone call: Transmit to an IP phone.\*

\*Transmittable, depending on a presetting.

#### About the Time-out Timer:

If continuous transmission exceeds the preset Time-Out Timer time, the transmission is cut off. Release [PTT], and then hold down again to resume talking.

## Advanced operation

### ◆ About the Talkgroup Call

The Talkgroup Call function enables the user to communicate with call-to parties in the same Talkgroup. For example, in the illustration below, when the IP730D “00105” in its normal group “10002,” selects Talkgroup “20001,” it is excluded from group “10002,” and can communicate with only the transceivers “00004” and “00108” that belong to Talkgroup “20001.”

- ① This function can be used for only when the Talkgroup number is registered, and the Talkgroup Call function is assigned to a key by your dealer.
- ② Ask your dealer about whether or not to include the Talkgroup in the All Call.

When Talkgroup is OFF

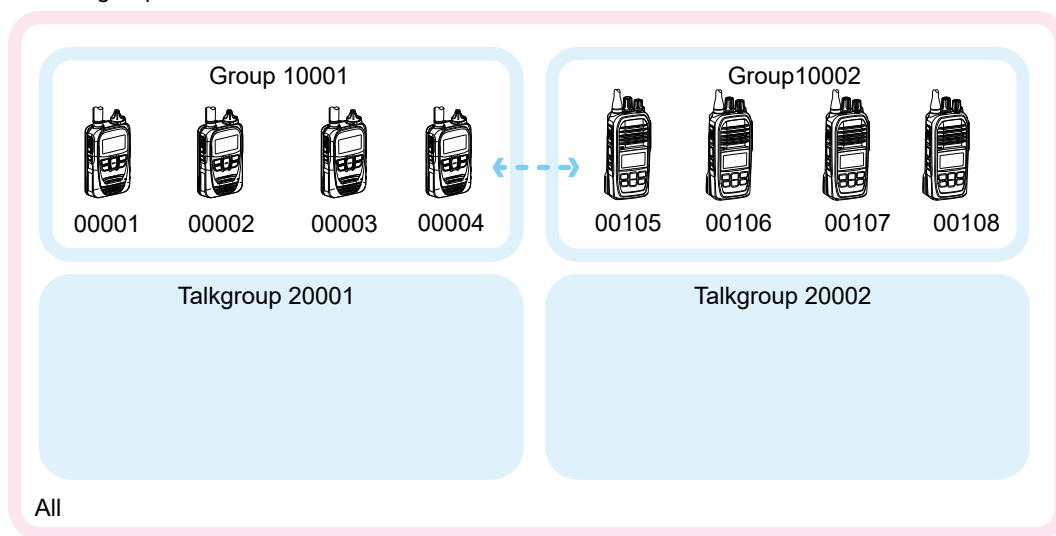

When Talkgroup is selected

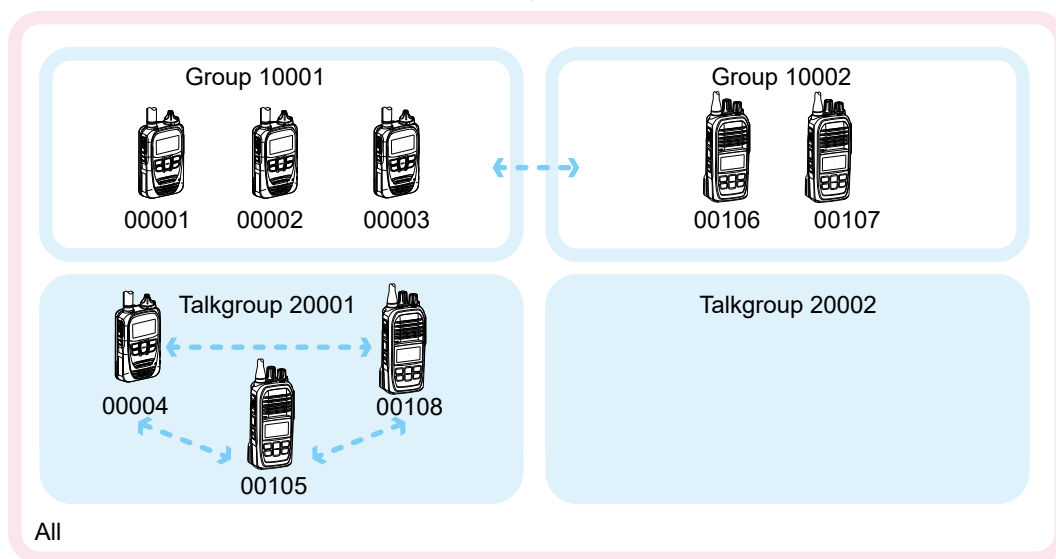

#### Advanced operation (Continued)

#### ◇ Selecting a Talkgroup number

You can select a Talkgroup number if the Talkgroup Call function is assigned to the [FUNC] key. Ask your dealer for details.

1. Push [FUNC] to display the Function.
  - The Function screen is displayed.
2. Push [FUNC] to display "Talkgroup," if another function is displayed.
  - ① You may need to push [FUNC] several times, depending on a presetting.
3. Rotate Rotary Selector or push [▲] or [▼] to select a Talkgroup number that you want to belong.
4. Push [CLR/Lock].
  - The transceiver is ready to talk to only the transceivers that belong to the same Talkgroup.
  - ① While the Talkgroup number is selected, you cannot transmit Normal Group call.
  - ① You can leave the Talkgroup and return to the Normal Group by selecting "OFF" in Step 2 on the "Talkgroup" screen.

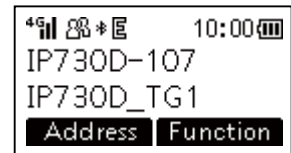
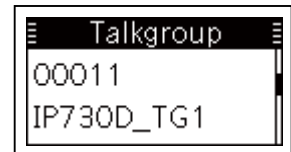

Advanced operation (Continued)

◇ Sending a message (Message Call)

You can send a message, depending on a presetting. Ask your dealer for details.

1. Selecting a call-to party

1. Push [Address] to display the Address book.
  - The Address book is displayed.
2. Push [Address] several times to toggle the call type.
  - ① Displayed call type may differ, depending on a presetting.

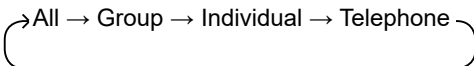

3. Rotate Rotary Selector or push [▲] or [▼] to select a call-to party.

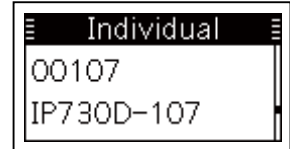

**TIP:** You can also select a call-to party from Call history.

1. Push [Call History] to display the Call history.
  - The Call history is displayed.
2. Push [Call History] several times to toggle the Call history between “Tx log,” “Rx log,” and “TX MSG log.”
  - ① The displayed log may differ, depending on a presetting.

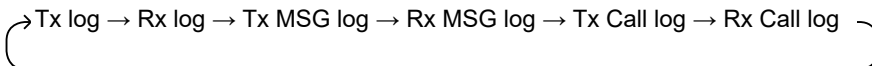

3. Rotate Rotary Selector or push [▲] or [▼] to select a call-to party.

2. Sending a message

Sending a preset message:

1. Push [FUNC] to display the Function.
  - The Function screen is displayed.
2. Push [FUNC] to display “Message,” if another function is displayed.
  - ① You may need to push [FUNC] several times, depending on a presetting.
3. Rotate Rotary Selector or push [▲] or [▼] to select a message to send.
  - The selected message may scroll, depending on the message length.

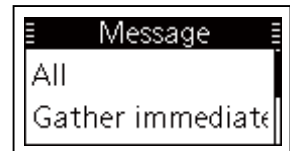

4. Push [PTT] to send a message.
  - ① “No Response” is displayed if the transmission failed.



#### Advanced operation (Continued)

#### ◇ Browsing received messages

You can browse received messages, depending on a presetting. Ask your dealer for details.

1. Push [Call History] to display the Call history.
  - The Call history is displayed.
2. Push [Call History] to display "Rx MSG log."
  - ① You may need to push [Call History] several times, depending on a presetting.
3. Rotate Rotary Selector or push [▲] or [▼] to browse received messages.
  - ① The selected message may scroll, depending on the message length.

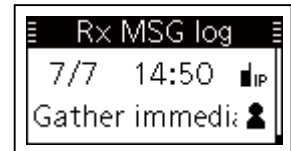

#### ◇ Status Call

You can send a Status call depending on a presetting. Ask your dealer for details.

1. Push [FUNC] to display the Function.
  - The Function screen is displayed.
2. Push [FUNC] to display "Status," if another function is displayed.
  - ① You may need to push [FUNC] several times, depending on a presetting.
3. Rotate Rotary Selector or push [▲] or [▼] to select a status.
4. Push [PTT] to send a status.





#### Advanced operation (Continued)

#### ◇ Toggling the SIM card

The transceiver has two SIM card slots, SIM 1 and SIM 2. You can toggle which SIM card to use in the Detailed Set mode.

1. Turn OFF the transceiver, if it is turned ON.
2. While holding down [Address] and [FUNC], rotate [VOL] to turn ON the transceiver.
  - The Detailed Set Mode is displayed.
  - ① Release the finger from keys when “SET (Detail)” is displayed.
3. Rotate Rotary Selector or push [▲] or [▼] to select an item group “Cellular,” and then push [FUNC].
4. Push [Address] or [FUNC] several times to select “SIM Selection.”
5. Rotate Rotary Selector or push [▲] or [▼] to select a SIM card to use.
  - ① The SIM card name may be displayed, if it is entered.
6. Push [CLR/Lock] to exit “SIM Selection.”
  - ① Push [CLR/Lock] again to exit the Detailed Set mode and return to the Standby screen.

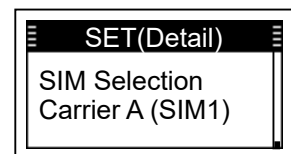
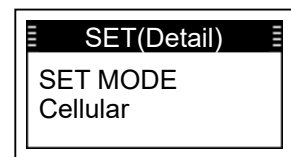

**TIP:** You can also push [FUNC] to display the “SIM Selection” screen by enabling the “Show SIM selection” in the Detailed Set mode (p. 6-8).

#### ◇ Pocket Beep function

The Pocket beep function sounds a notification tone and indication when a call is received.

- ① This function is set by your dealer, or in the Set mode.
- ① “📞” is displayed when the function is ON.
- ① “📞” blinks and the notification beep sounds when a call is received. It blinks until the transceiver returns to the standby mode after a received signal disappears.

#### ◇ P-Bell function

The P-Bell function sounds the notification tone when a call is received. A received call is muted until you reply. After pushing [PTT], the mute is released.

- ① This function is set by your dealer, or in the Set mode.
- ① “P” is displayed when the function is ON.

## Section 4 USING THE IDAS MODE

---

Basic operation.....	4-2
◇ Operating keys.....	4-2
◇ Selecting a Zone.....	4-3
◇ Selecting a channel .....	4-3
◇ Receiving and transmitting .....	4-3
◇ Transmitting Notes.....	4-3
Other functions .....	4-4
◇ Radio Access Number (RAN) .....	4-4
◇ Encryption function .....	4-4

## Basic operation

### ◇ Operating keys

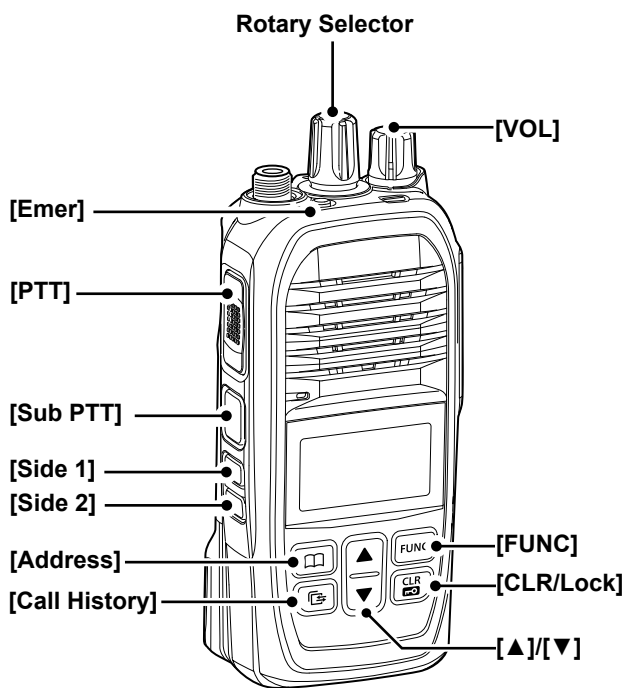

<b>Rotary Selector</b>	Rotate to select a channel, scroll the screen, or move the cursor.
<b>[Emer]</b>	Hold down until “Emergency” is displayed to send an Emergency call. (p. 5-5)
<b>[PTT]</b>	Hold down to transmit, release to receive.
<b>[Sub PTT] [Side 1] [Side 2]</b>	Functions may be assigned, depending on a presetting. See page 5-10 for assignable function details. You can also assign functions in the Detailed Set mode. (p. 6-5)
<b>[Address]</b>	<ul style="list-style-type: none"> <li>• Push to display the Call-to party selection screen</li> </ul>
<b>[Call History]</b>	<ul style="list-style-type: none"> <li>• Push to display the call history.</li> <li>• Push this key several times to toggle between the Call history types, Transmitted call, Received call, and Recording Log.</li> <li>• Hold down for 1 second to playback a selected Recording log (p. 5-9).</li> </ul>
<b>[▲]/[▼]</b>	Push to scroll the screen, move the cursor, or selecting a channel.
<b>[CLR/Lock]</b>	<ul style="list-style-type: none"> <li>• Push to return to the standby screen.</li> <li>• Hold down for 1 second to turn the Key Lock function ON or OFF. (p. 2-4)</li> </ul> <p>① [PTT], [Sub PTT], [VOL], [Emer], and the Monitor function are usable even while the Key Lock function is ON.</p>
<b>[FUNC]</b>	<ul style="list-style-type: none"> <li>• Push to display the Function screen.</li> <li>• In the function screen, push several times to select functions such as Operating mode selection, and so on*.</li> </ul> <p>*Selectable function may differ, depending on a Set mode setting.</p>
<b>[VOL]</b>	<ul style="list-style-type: none"> <li>• Rotate to turn ON or OFF the transceiver.</li> <li>• Rotate to adjust the audio output level.</li> </ul>

### Basic operation (Continued)

#### ◇ Selecting a Zone

Certain channels are grouped together and assigned to a Zone according to their intended use.

For example, Analog channels 'Station 1' and 'Station 2' are assigned to an "Analog" Zone, and Digital channels 'Station 3' and 'Station 4' are assigned to a "Digital" Zone.

① Confirm that the function to enter the Zone Selection screen is assigned to [Sub PTT], [Side 1], or [Side 2]. You can assign functions in the Detailed Set mode. See page 6-5 for details.

1. Push or hold down the key that is assigned for entering the Zone Selection screen.
2. Rotate Rotary Selector or push [▲] or [▼] select a zone.
3. Push [Call History] to exit the Zone Selection screen and return to the Standby Screen.

#### ◇ Receiving and transmitting

##### Receiving:

1. Rotate Rotary selector, or push [▲] or [▼] to select a channel.
  - When a Call is received, the Status indicator lights green.

##### Transmitting:

**CAUTION: DO NOT** transmit without an antenna.

1. Wait until the channel is clear to avoid interference.
2. While holding down [PTT], speak at your normal voice level.
3. Release [PTT] to receive.

##### IMPORTANT:

To maximize the readability of your signal:

1. After pushing [PTT], pause briefly before you start speaking.
2. Hold the microphone 5 to 10 cm (2 to 4 inches) from your mouth, then speak at your normal voice level.

**NOTE:** You can only transmit at low power in the IDAS mode when using an optional BP-305 battery case and alkaline batteries.

#### ◇ Transmitting Notes

##### ○ Transmit inhibit function

The transceiver has several inhibit functions which restrict transmission under the following conditions:

##### Lockout function:

The function inhibits transmission when the channel is busy. However, depending on a presetting, you can transmit when a call is received that includes a non-matching (or matching) CTCSS (DTCS), RAN (Radio Access Number), Individual ID, or Group ID.

##### Time-Out Timer:

If continuous transmission exceeds the preset Time-Out Timer time, the transmission is cut off. Release [PTT], and then hold down again to resume talking.

##### Penalty timer:

After the transmission is cut off by the Time-Out Timer, transmission is further inhibited for a preset penalty period of time.

## Other functions

### ◇ Radio Access Number (RAN)

Radio Access Number (RAN) is a signaling system designed for digital radio communications. When a channel is set up with a RAN, the squelch will open only when a call containing a matching RAN\* is received. If a call containing a different RAN is made on the same channel a user is using, a user will not hear the call.

\*Depending on the settings, not only RAN but also individual ID or group ID must match.

### ◇ Encryption function

The Encryption function enables voice scrambling, which provides private digital communication between stations.

When an encrypted call is received, the audio is heard only when the call contains a matching Key ID and Encryption key.

If a call containing a different ID is made on the same channel, the squelch will not open, and the user will not hear the call.

Push [Encryption] to toggle the Encryption function ON or OFF.

- “” is displayed when the Encryption function is ON.

① When the Encryption function is ON, push [PTT] to make an encrypted call.

## Section 5 OTHER FUNCTIONS

---

◇ About the VS-3 Bluetooth headset .....	5-2
◇ Pairing with a Bluetooth device.....	5-3
◇ Settings for the Bluetooth function.....	5-3
◇ Disconnecting a paired device.....	5-4
◇ Initializing the Pairing lists.....	5-4
Using the Emergency call function .....	5-5
◇ The Man Down function.....	5-6
◇ The Lone Worker function.....	5-7
◇ The Stationary Detection function.....	5-8
◇ The Motion Detection function .....	5-8
Using the Voice Recorder function .....	5-9
◇ Using the Voice Recorder function .....	5-9
◇ Deleting the recorded audio.....	5-9
Using assignable keys.....	5-10
Using the Dual mode .....	5-11
◇ Main mode and Sub mode.....	5-11
◇ Transmitting .....	5-11

## Using a Bluetooth® device

The transceiver can operate with Bluetooth headsets.

① Only the VS-3 headset performance is guaranteed as of December 2020.

- The Bluetooth function may not be usable, depending on a presetting. Ask your dealer for details.
- The communication range of Bluetooth is approximately 10 m (33 ft).  
① May vary, depending on the environment in which the device operates.
- Although you can enter up to 6 Bluetooth devices in the transceiver device list, it is recommended that you pair only one device at a time.

### Electromagnetic Interference

When you use a Bluetooth device, pay attention to the following: Bluetooth devices operate in the 2.4 GHz band that is also used by other appliances, such as Wireless LAN products, microwave ovens, RFID systems, amateur radio stations, and so on.

When using a Bluetooth device near such devices, interference may occur, causing a decrease in communication speed, and an unstable connection.

In such case, keep the Bluetooth devices away from the other appliances, or stop using those devices.

Bringing the Bluetooth device and the transceiver closer together also improves communication.

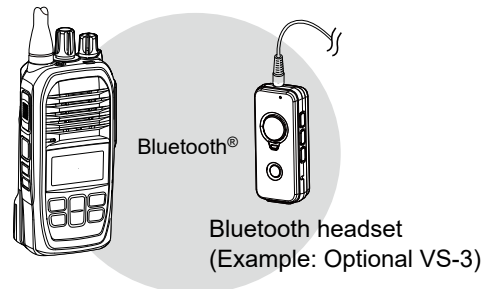

### ◇ About the VS-3 Bluetooth headset

When you connect an optional VS-3 Bluetooth headset to the transceiver, you can wirelessly transmit and receive the headset audio.

The VS-3 has a [PTT] switch, so you can transmit in the same way as using the transceiver's [PTT] switch.

- The [FWD], [RWD], and [PLAY] keys on the VS-3 are disabled while using the headset with the IP730D or IP740D.
- If the headset does not work correctly, even if the power is ON, push [RESET] with a pin to force power OFF.

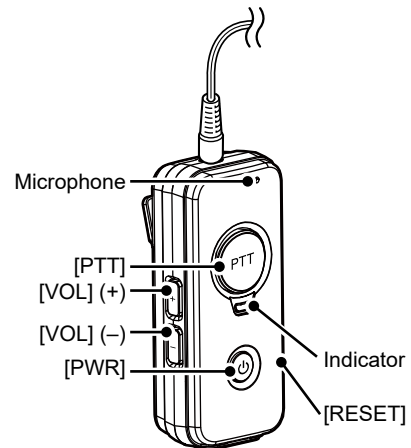

Function		Operation	Beep tone	Indicator
Bluetooth function	ON	Hold down [PWR] for 3 seconds	Melody (up)	Blinks blue
	OFF		Melody (down)	OFF
Pairing mode	Searching	While Bluetooth function is OFF, hold down [PWR] for 6 seconds	PiPa- (ready to connect)	Quickly blinks red then blue, every 3 seconds
	Connected		PiRo	Blinks blue twice, every 3 seconds
Transmit*1		Push [PTT]	Pi*2	Blinks red once, then blue twice, every 3 seconds
Audio volume	Up*1	Push [VOL] (+)	Pi	—
	Down*1	Push [VOL] (-)	Boo	—

\*1Functional only when a Bluetooth device is connected.

\*2Depends on the Notice Tone settings or "BT PTT Beep" setting in the Set mode.

Using a Bluetooth® device (Continued)

◇ Pairing with a Bluetooth device

This is an example of connecting the transceiver to a VS-3 Bluetooth headset.

1. Entering the VS-3 Pairing mode

1. Confirm the VS-3 is turned OFF.
2. Hold down [PWR] for 6 seconds.
  - The indicator quickly blinks red then blue, and then the headset enters the Pairing mode.

**NOTE:**

- Charge the VS-3 before operating.
- The VS-3 starts up in the Pairing mode when its Bluetooth function is ON, but no bluetooth device is entered in its Pairing list.

2. Enable the transceiver's Bluetooth function

1. Turn OFF the transceiver, if it is turned ON.
2. While holding down [FUNC], rotate [VOL] to turn ON the transceiver.
  - The Set Mode is displayed.
  - ① Release [FUNC] when "SET MODE" is displayed.
3. Rotate Rotary Selector or push [▲] or [▼] to select an item group "Common," and then push [FUNC].
4. Push [FUNC] or [Address] several times to select "Bluetooth."
5. Rotate Rotary Selector or push [▲] or [▼] to select "ON."

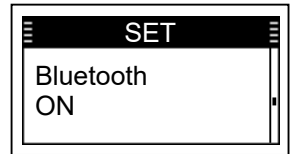

3. Pairing and connecting the Bluetooth device

1. Push [FUNC] several times to select "Search BT Device" in the Set mode, and then push [Call History].
  - The transceiver searches for a Bluetooth device.
  - ① Push [CLR/Lock] to cancel searching.
  - If found, the device's name and BD address are displayed on the screen. (Example: ICOM BT-002)

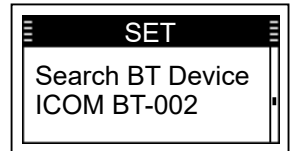

2. Push [▲] or [▼] to select the headset to pair and connect, and then push [Call History].
  - "Connect" is displayed when the pairing has completed.

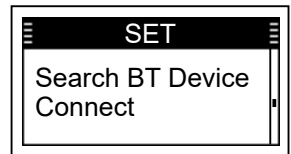

3. Push [CLR/Lock] to exit "Search BT Device."
  - ① Push [CLR/Lock] again to exit the Set mode and return to the Standby screen.
  - "BT" is displayed if the headset has correctly paired.

◇ Settings for the Bluetooth function

You can customize the transceiver's Bluetooth settings in the Set mode. See the Set mode section for details.



Using a Bluetooth® device (Continued)

◇ **Disconnecting a paired device**

You can disconnect a paired Bluetooth device if it is not being used.

1. In the standby screen, push [FUNC] several times to select “Pairing List.”
  2. Push [▲] or [▼] to select the device to disconnect, and then push [Call History].
    - “Unconnected” is displayed if the headset or device is correctly disconnected.
- ① Do the same steps to reconnect to the Bluetooth device.



◇ **Initializing the Pairing lists**

If you have problems with Bluetooth operation, initialize the pairing lists, as shown below.

**Initializing the Pairing list of the transceiver**

- ① All the paired Bluetooth devices are deleted from the Pairing list by the initialization.  
② The Pairing list is not initialized by the RESET function in the Detailed Set mode.
1. Turn OFF the transceiver, if it is turned ON.
  2. While holding down [FUNC], rotate [VOL] to turn ON the transceiver.
    - The Set Mode is displayed.
- ① Release [FUNC] when “SET MODE” is displayed.
3. Rotate Rotary Selector or push [▲] or [▼] to select an item group “Common,” and then push [FUNC].
  4. Push [FUNC] or [Address] several times to select “Init BT Unit.”
  5. Rotate Rotary Selector or push [▲] or [▼] to select “Clear.”
  6. Push [Call History] to initialize the Pairing Lists.
    - The pairing list is initialized, and the transceiver automatically restarts.

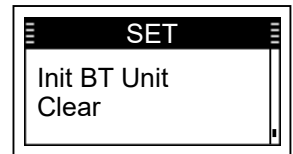

**Initializing the Pairing list of the VS-3**

1. Hold down [PWR] on the VS-3 for 3 seconds, to turn ON the Bluetooth function.
  - The indicator blinks blue.
2. Hold down [PWR] on the VS-3 for 3 seconds again, to turn OFF the Bluetooth function.
  - The indicator turns OFF.
3. Within 10 seconds, while holding down both [VOL] (+) and [VOL] (–), hold down [PWR] for 10 seconds.
  - The indicator lights violet, then turns OFF after the pairing list is initialized.

## Using the Emergency call function

You can receive or transmit Emergency Call if the function is enabled.

### Transmitting:

The instruction is for when the function is enabled. Ask your dealer for details.

1. Hold down [Emer] until “Emergency” is displayed.
  - An alarm periodically sounds.
  - ① If the Surveillance function is enabled, no alarm sounds.
2. Wait for an answer-back.
  - When the transceiver receives an answer-back, the alarm stops, and the Status indicator lights green.
  - ① Turn OFF the transceiver to cancel the emergency call.
  - ① The transceiver automatically transmits a repeat Emergency call until it receives an acknowledgement, or until a user turns OFF the transceiver.



### Receiving:

1. “Emergency” is displayed and the alarm periodically sounds.
  - ① If the Surveillance function is enabled, no alarm sounds.
2. While holding down [PTT], talk into the microphone.
  - While holding down [PTT], the Status indicator lights red.
  - The alarm stops.
  - Returns to the Standby screen when you release [PTT].



**NOTE:** The Emergency function may not properly work, depending on the surrounding environment such as obstructions, weather condition, and so on. Icom is not responsible for the destruction or damage caused by using the Emergency Call function.

Using the Emergency Call function (Continued)

The transceiver enters the Emergency mode through the following functions, depending on a presetting:

◇ The Man Down function

When the transceiver is tilted past the preset angle for the ON Timer preset time, the transceiver enters the Emergency mode.

- ① If a user raises the transceiver back from the preset angle towards the vertical position before the Reminder Timer set time expires, the Emergency mode is canceled.

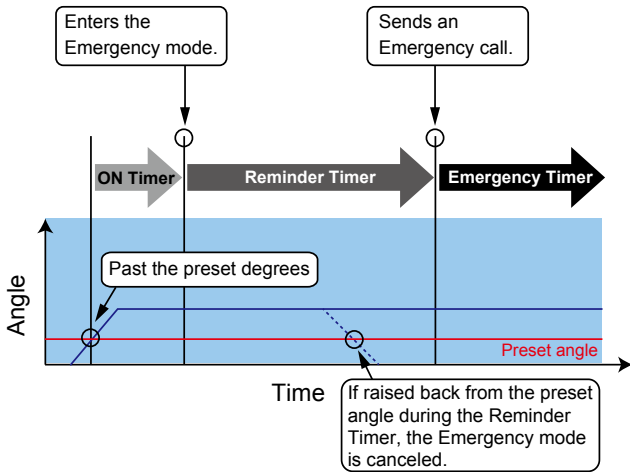

Man Down With Stationary:

- The transceiver leans past the preset angle for the ON Timer preset time.
- AND
- The transceiver is detected as stationary (no motion) for the ON Timer set time.

- ① If a user raises the transceiver back from the preset angle towards the vertical position, or when the user moves the transceiver before the Reminder Timer set time expires, the Emergency mode is canceled.

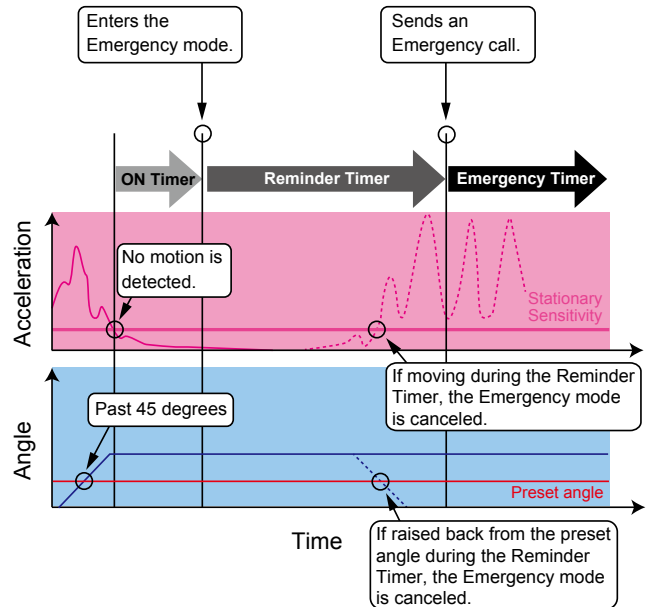

**NOTE:** The Man down function may not properly work, depending on the surrounding environment such as obstructions, weather condition, and so on. Icom is not responsible for the destruction or damage caused by using the Man Down function.

Using the Emergency Call function (Continued)

The transceiver enters the Emergency mode through the following functions, depending on a presetting:

◆ The Lone Worker function

When no operation occurs for the ON Timer preset time.

- ① If a user pushes any key before the Reminder Timer set time expires, the Emergency mode is canceled.

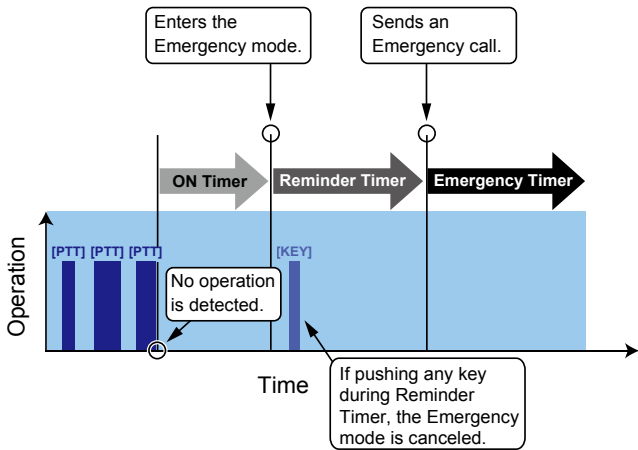

Lone Worker With Stationary:

- When no operation occurs for the ON Timer preset time.
- AND
- The transceiver is detected as stationary (no motion) for the ON Timer set time.

- ① If a user pushes any key, or moves the transceiver before the Reminder Timer set time expires, the Emergency mode is canceled.

Example:

- ON Timer: 60 minutes
- Reminder Timer: 60 seconds

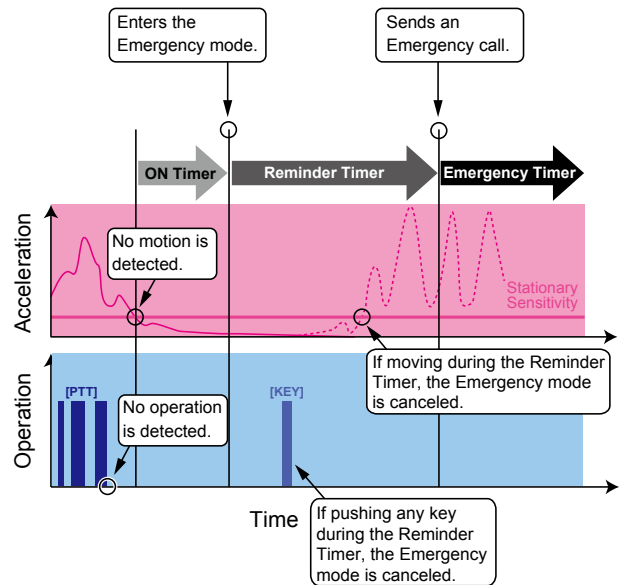

**NOTE:** The Lone Worker function may not properly work, depending on the surrounding environment such as obstructions, weather condition, and so on. Icom is not responsible for the destruction or damage caused by using the Lone Worker function.

Using the Emergency Call function (Continued)

The transceiver enters the Emergency mode through the following functions, depending on a presetting:

◇ The Stationary Detection function

When the transceiver is detected as being stationary (no motion) for the ON Timer preset time.

- ① If a user moves the transceiver during the Reminder Timer set time, the Emergency mode is canceled.

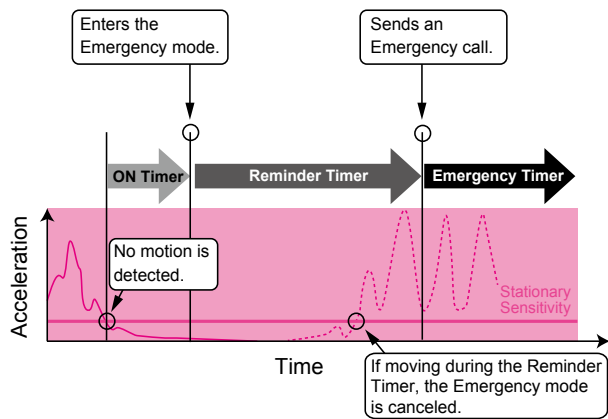

**NOTE:** The Stationary Detection function may not properly work, depending on the surrounding environment such as obstructions, weather condition, and so on.  
Icom is not responsible for the destruction or damage caused by using the Stationary Detection function.

◇ The Motion Detection function

When the transceiver continuously moves for the ON Timer preset time.

- ① If a user holds down [Emer] for the Emer SW OFF Timer (Sec) set time, before the Reminder Timer set time expires, the Emergency mode is canceled.

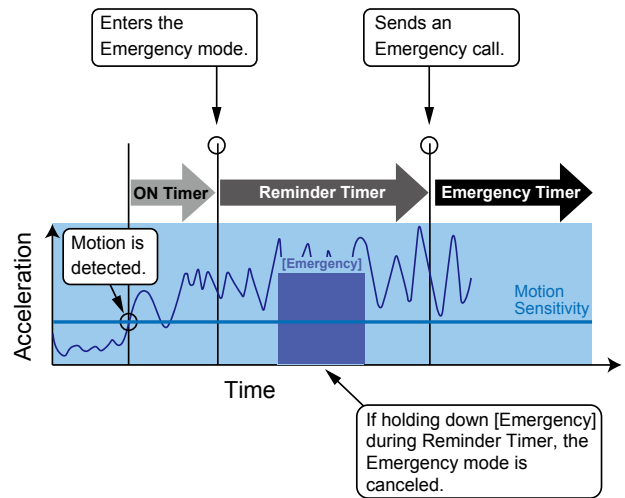

**NOTE:** The Motion Detection function may not properly work, depending on the surrounding environment such as obstructions, weather condition, and so on.  
Icom is not responsible for the destruction or damage caused by using the Motion Detection function.

## Using the Voice Recorder function

The transceiver can record and playback up to 10 of the latest incoming calls, depending on a presetting.

- ① Records up to 4 minutes per call. If a call is longer than 4 minutes, the older will be automatically deleted.
- ① The recordable call type may differ, depending on a presetting.
- ① A recorded audio data cannot be exported.
- ① This function does not record analog audio.

### ◇ Using the Voice Recorder function

#### 1. Enable the Voice Recorder function

1. Turn OFF the transceiver, if it is turned ON.
2. While holding down [FUNC], rotate [VOL] to turn ON the transceiver.
  - The Set Mode is displayed.
  - ① Release finger from [FUNC] when "SET MODE" is displayed.
3. Rotate Rotary Selector or push [▲] or [▼] to select an item group "Common," and then push [FUNC].
4. Push [FUNC] or [Address] several times to select "Recording."
5. Rotate Rotary Selector or push [▲] or [▼] to select "ON."
6. Push [CLR/Lock] to exit "Recording."
  - ① Push [CLR/Lock] again to exit the Set mode and return to the Standby screen.

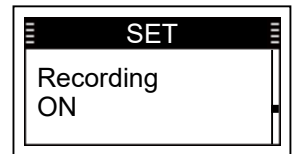

#### 2. Turning ON the Voice Recorder function

1. Push [FUNC] to display the Function.
  - The Function screen is displayed.
2. Push [FUNC] to display "Recording," if another function is displayed.
  - ① You may need to push [FUNC] several times, depending on a presetting.
3. Rotate Rotary Selector or push [▲] or [▼] to select "ON."
4. Push [CLR/Lock] to return to the Standby screen.
  - "🔊" is displayed.



#### 3. Playing back the recorded audio

"🔊" blinks in the Standby Screen if there is recorded audio that has not been played back.

1. Push [Call History] to display the Function.
  - The Call History is displayed.
2. Push [Call History] several times to toggle the Call history from "Tx log," "Rx log," "TX MSG log," "RX MSG log," or "Recording Log."
  - ① Displayed log may differ, depending on a presetting.
3. Push [▲] or [▼] to select a audio to playback.

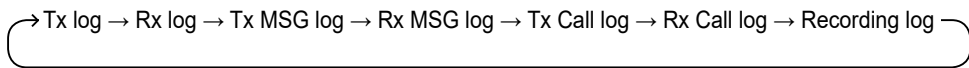

4. Hold down [Call History] for 1 second to playback the audio.
  - ① Push [▲] or [▼] to stop playing back the audio.

### ◇ Deleting the recorded audio

1. Turn OFF the transceiver, if it is turned ON.
2. While holding down [FUNC], rotate [VOL] to turn ON the transceiver.
  - The Set Mode is displayed.
  - ① Release finger from [FUNC] when "SET MODE" is displayed.
3. Rotate Rotary Selector or push [▲] or [▼] to select an item group "Common," and then push [FUNC].
4. Push [FUNC] or [Address] several times to select "Delete Recording."
5. Rotate Rotary Selector or push [▲] or [▼] to select "Clear."
6. Push [Call History] to delete the recorded audio.
7. Push [CLR/Lock] to exit "Delete Recording."
  - ① Push [CLR/Lock] again to exit the Set mode and return to the Standby screen.

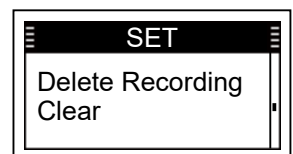

## Using assignable keys

Functions shown below may be assigned to the [Sub PTT], [Side 1], and [Side 2] keys, depending on a presetting. Hold down or push these keys to use assigned functions.

You can also assign these functions in the Detailed Set mode (p. 6-5).

Function	Descriptions
Zone	Enter the Zone* Selection screen. *Certain channels are grouped together and assigned to a Zone according to their intended use. For example, Analog channels 'Station 1' and 'Station 2' are assigned to an "Analog" Zone, and Digital channels 'Station 3' and 'Station 4' are assigned to a "Digital" Zone.
Monitor	Turn ON the monitor function. The function turn the squelch mute or the CTCSS (DTCS) squelch mute ON or OFF.
Talk Around	Turn ON the Talk Around function. The function equalizes the transmit frequency to the receive frequency, for direct (Simplex) communication.
Message	Push to directly display the Message screen. ① The Message screen displayed by the first push differs depending on a presetting.
One Touch	Push to directly select particular call-to party. ① The selectable call-to party differs depending on a presetting.
Surveillance	Turn ON the Surveillance function. When this function is turned ON, the beep is not heard and the backlight and the Status indicator do not light, even when a signal is received, or a key is pushed.
AquaQuake™	While holding down this key, the AquaQuake water draining function removes water from the speaker grill by vibrating the internal speaker. ① Water in the speaker grill may muffle the sound coming from the speaker. ① After the specified period of time, this function automatically stops, even if a user continues to hold down this key. ① This key works with only the internal speaker.

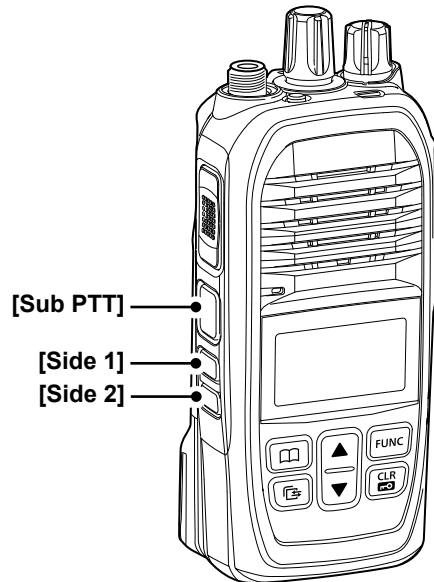

## Using the Dual mode

You can use the Cellular mode and IDAS mode at the same time.

### ◇ Main mode and Sub mode

When the Dual mode is selected, the Main mode and Sub mode are displayed as shown to the right.

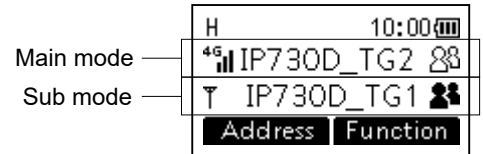

### Switching the operating mode:

- Hold down [FUNC] for 1 second to toggle the Main mode and Sub mode.

### ◇ Transmitting

- Hold down [PTT] to transmit in the Main mode.
- Hold down [Sub PTT] to transmit in the Sub mode.
- ① You can also simultaneously transmit\* in both modes by holding down both [PTT] and [Sub PTT].
  - \*The Status indicator lights yellow.
- ① A channel, call to - party, or call type are not selectable in the Sub mode. To select those, switch to the Main mode.

**NOTE:** Functions shown below are not usable in the Dual mode.

- Sending or receiving a message
- VOX function
- P-Bell function



# Section 6

# SET MODE

---

Using the Set mode.....	6-2
◇ Basic Set mode.....	6-2
◇ Detailed Set mode .....	6-2
◇ Using the Set mode .....	6-2
Set mode items.....	6-3
◇ Common .....	6-3
◇ Cellular.....	6-7
◇ IDAS .....	6-9

## Using the Set mode

You can use the Set mode to set infrequently changed values or function settings. The transceiver has 2 types of Set modes, as shown below.

① You cannot transmit or receive while the transceiver is in the Set mode.

### ◇ Basic Set mode

1. Turn OFF the transceiver, if it is turned ON.
2. While holding down [FUNC], rotate [VOL] to turn ON the transceiver.
  - The Set mode is displayed.
  - ① Release finger from [FUNC] when “SET” is displayed.
3. Rotate Rotary Selector or push [▲] or [▼] to select an item group “Common,” “Cellular,” or “IDAS,” and then push [FUNC].
  - ① Select “Certification” and then push [FUNC] to display certification information.

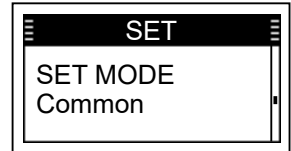

### ◇ Detailed Set mode

1. Turn OFF the transceiver, if it is turned ON.
2. While holding down [FUNC] and [Address], rotate [VOL] to turn ON the transceiver.
  - The Detailed Set mode is displayed.
  - ① Release finger from [FUNC] when “SET (Detail)” is displayed.
3. Rotate Rotary Selector or push [▲] or [▼] to select an item group “Common,” “Cellular,” or “IDAS,” and then push [FUNC].

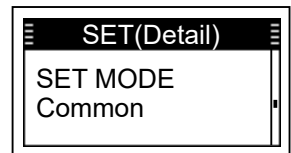

### ◇ Using the Set mode

#### Example: Disabling the key touch beep.

1. Turn OFF the transceiver, if it is turned ON.
2. While holding down [FUNC] and [Address], rotate [VOL] to turn ON the transceiver.
  - The Detailed Set mode is displayed.
  - ① Release finger from [FUNC] when “SET (Detail)” is displayed.
3. Rotate Rotary Selector or push [▲] or [▼] to select an item group “Common,” and then push [FUNC].
4. Push [FUNC] or [Address] several times to select “Key-Touch Beep.”
5. Rotate Rotary Selector or push [▲] or [▼] to select “OFF.”
6. Push [CLR/Lock] to exit “Key-Touch Beep.”
  - ① Push [CLR/Lock] again to exit the Set mode and return to the Standby screen.

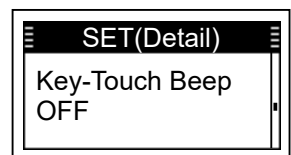

## Set mode items

The shaded items are also displayed in the Basic Set mode.

① Items or default values may be differ, depending on the transceiver's version or presets. Ask your dealer for details.

### ◇ Common

Item	Description	Option/range	Default
LOG CLEAR	Deletes logs. ① Select "Clear," and then push [Call History] to delete.	---, Clear	---
FIRM UP	Updates the transceiver's firmware. ① Select "YES," and then push [Call History] to update the firmware. ① The transceiver automatically restarts. ① Updating the firmware takes approximately 10 minutes.	NO or YES	NO
RX Notify Vol.	Sets the call or message received notification volume.	0 ~ 32	10
Notify Vol.	Sets the Notification Beep level.	0 ~ 32	10
Key-Touch Beep	Selects whether or not to enable the Key-touch beep.	ON or OFF	ON
Internal Mic Gain	Sets the internal microphone sensitivity. ① Higher values make the microphone more sensitive to your voice.	-12 dB ~ 12 dB (in 4 dB step)	0 dB
External Mic Gain.	Sets the external microphone sensitivity. ① Higher values make the microphone more sensitive to your voice.	-12 dB ~ 12 dB (in 4 dB step)	0 dB
VOX	Selects whether or not to use the VOX function. The function automatically switches between receive and transmit by detecting your voice.	OFF, Bluetooth Mic, or Earphone Mic/Headset	OFF
VOX Threshold* <sup>1</sup>	Sets the VOX gain level. ① Lower values make the VOX function more sensitive to your voice.	1 ~ 10	5
VOX Delay* <sup>1</sup>	Sets the period of time the transceiver continues transmitting after the user stops speaking, and then the VOX switches to receive. ① If you set the time too short, a pause in a conversation may be regarded as the end of conversation, and the transceiver will start receiving, even as the conversation continues.	0.5 ~ 3.0	1.0

\*<sup>1</sup> Displayed only when "Bluetooth Mic," or "Earphone Mic" is selected in the "VOX" item.

## 6 SET MODE

### Set mode items (Continued)

The shaded items are also displayed in the Basic Set mode.

① Items or default values may differ, depending on the transceiver's version or presets. Ask your dealer for details.

#### ◇ Common

Item	Description	Option/range	Default
Man Down* <sup>2</sup>	Selects whether or not to enable the Man Down function. The transceiver enters the Emergency mode when it is tilted past the preset angle for a certain time. (p. 5-6)	OFF or ON	OFF
Lone Worker* <sup>2</sup>	Selects whether or not to enable the Lone Worker function. The transceiver enters the Emergency mode when no operation occurs for a certain time. (p. 5-7)	OFF or ON	OFF
Stationary Detection* <sup>2</sup>	Selects whether or not to enable the Stationary Detection function. The transceiver enters the Emergency mode when it is detected as being stationary (no motion) for a certain time. (p. 5-8)	OFF or ON	OFF
Motion Detection* <sup>2</sup>	Selects whether or not to enable the Motion Detection function. The transceiver enters the Emergency mode when it continuously moves for a certain time. (p. 5-8)	OFF or ON	OFF
Recording	Selects whether or not to enable the Voice Recorder function. (p. 5-9)	OFF or ON	OFF
Record Call type* <sup>3</sup>	Selects a type of call to record.	Individual Call or All	Individual Call
Delete Recording* <sup>3</sup>	Deletes recorded audio. ① Select "Clear," and then push [Call History] to delete.	--- or Clear	---
Noise Canceller	Selects whether or not to enable the Noise Cancelling function.	ON or OFF	ON
PTT Lock	Selects whether or not to enable the PTT function. The function inhibits transmission by the internal PTT.	OFF or ON	OFF
Operate Inhibit	Selects whether or not to inhibit the operation except using [VOL].	OFF or ON	OFF
Sub PTT Push* <sup>4</sup>	Sets the function to execute when you push [Sub PTT].	Null, Zone, Monitor, Talk Around, Message, One Touch, or Surveillance	Null
Sub PTT Hold* <sup>4</sup>	Sets the function to execute when you hold down [Sub PTT].	Null, Zone, Monitor, Talk Around, Message, One Touch, Surveillance, or AquaQuake	Null

\*<sup>2</sup> Displayed only when the Emergency Call function is enabled by your dealer.

\*<sup>3</sup> Displayed only when "ON" is selected in the "Recording" item.

\*<sup>4</sup> In Dual mode, transmits in Sub mode regardless of the setting.

## 6 SET MODE

### Set mode items (Continued)

The shaded items are also displayed in the Basic Set mode.

① Items or default values may be differ, depending on the transceiver's version or presets. Ask your dealer for details.

#### ◇ Common

Item	Description	Option/range	Default
Side 1 Push	Sets the function to execute when you push [Side 1].	Null, Zone, Monitor, Talk Around, Message, One Touch, or Surveillance	Null
Side 1 Hold	Sets the function to execute when you hold down [Side 1].	Null, Zone, Monitor, Talk Around, Message, One Touch, Surveillance, or AquaQuake	Null
Side 2 Push	Sets the function to execute when you push [Side 2].	Null, Zone, Monitor, Talk Around, Message, One Touch, or Surveillance	Null
Side 2 Hold	Sets the function to execute when you hold down [Side 2].	Null, Zone, Monitor, Talk Around, Message, One Touch, Surveillance, or AquaQuake	Null
Backlight	Selects a Backlight option.	Auto, ON, or OFF	Auto
Brightness	Selects a Backlight brightness option.	Light or Dark	Light
Contrast	Sets the screen contrast.	1 ~ 16	8
Bluetooth	Selects whether or not to enable the Bluetooth function. (p. 5-2)	OFF or ON	OFF
BT Auto Connect* <sup>5</sup>	Selects whether or not to automatically connect a Bluetooth device.	OFF or ON	ON
BT Sync Vol.* <sup>5</sup>	Selects whether or not to synchronize the Bluetooth headset's volume level with the transceiver's volume level. ① When "ON" is selected, the Bluetooth headset volume can be set by rotating [VOL].	OFF or ON	OFF
BT Connect Type* <sup>5</sup>	Selects the Synchronous Connection-Oriented (SCO) link* <sup>4</sup> connection type of a Bluetooth headset. When "Auto Disconnect" is selected, the SCO link is automatically disconnected after 2 seconds. * <sup>4</sup> A Bluetooth link for voice communication. ① This setting is valid only when a Bluetooth device other than a VS-3 is used. ① When this item is set to "Auto Disconnect," the VOX function is not usable.	Always Connect or Auto Disconnect	Always Connect
BT PTT & Mic Switch* <sup>5</sup>	Enables the user to select which microphone to use. ① When this item is set to "Auto," transmits the audio from the device whose [PTT] is pushed.	Auto, Bluetooth Mic, or Radio Mic	Auto
BT AF Output* <sup>5</sup>	Selects the AF Output device when a Bluetooth headset is connected.	BT Only or BT & SP	BT Only
BT Mic Gain* <sup>5</sup>	Sets the Bluetooth microphone sensitivity. ① Higher values make the microphone more sensitive to your voice.	-12 dB ~ 12 dB (in 4 dB step)	0 dB

\*<sup>4</sup> In Dual mode, transmits in Sub mode regardless of the setting.

\*<sup>5</sup> Displayed only when "ON" is selected in the "Bluetooth" item.

## 6 SET MODE

### Set mode items (Continued)

The shaded items are also displayed in the Basic Set mode.

① Items or default values may be differ, depending on the transceiver's version or presets. Ask your dealer for details.

#### ◇ Common

Item	Description	Option/range	Default
BT Echo Cancellor* <sup>5</sup>	Selects whether or not to enable the Bluetooth headset's Echo Cancellor.	ON or OFF	ON
BT E-Cancel Gain* <sup>5</sup>	Sets the Echo Cancellor input gain for a Bluetooth headset.	-40 dB ~ 40 dB	0dB
BT E-Cancel Delay* <sup>5</sup>	Sets the Echo Cancellor delay for a Bluetooth headset.	0 milliseconds ~ 160 milliseconds	70 milliseconds
BT Noise Cancel* <sup>5</sup>	Selects whether or not to enable the Bluetooth headset's Noise Cancellor.	ON or OFF	ON
BT Power Save* <sup>5</sup>	Selects whether or not to enable the Bluetooth headset's Power Save function. ① When "ON" is selected, the Power Save function automatically activates after 2 minutes of no communication.	OFF or ON	OFF
BT One Touch PTT* <sup>5</sup>	Selects whether or not to enable the One-Touch PTT function while a Bluetooth headset is connected. The function toggles receiving and transmitting by momentarily pushing [PTT] on a Bluetooth headset. ① Push [PTT] to talk, and push again to return to receive. ② When "ON" is selected, you do not have to hold down [PTT] while you are talking.	OFF or ON	OFF
Show BT One Touch PTT* <sup>5</sup>	Selects whether or not to display the "BT One Touch PTT" item by pushing [FUNC] on the standby screen.	OFF or ON	OFF
BT PTT Beep* <sup>5</sup>	Selects whether or not to sound a beep when the [PTT] on the Bluetooth headset is pushed.	OFF or ON	OFF
Search BT Device* <sup>5</sup>	Searches for Bluetooth devices. ① Push [Call History] to start searching.	Search	Search
Delete BT Device* <sup>5</sup>	Deletes paired devices.	-	No Device
Init BT Unit* <sup>5</sup>	Initializes the built-in Bluetooth unit and pairing list.	--- or Clear	---
BT Unit Version	Displays the built-in Bluetooth unit version.	-	-
RESET	Resets the transceiver to its defaults, except for the Bluetooth pairing list. ① Select "Run," and then push [Call History] to reset. ② The transceiver automatically restarts.	NO or YES	NO

\*<sup>5</sup> Displayed only when "ON" is selected in the "Bluetooth" item.

## 6 SET MODE

### Set mode items (Continued)

The shaded items are also displayed in the Basic Set mode.

① Items or default values may differ, depending on the transceiver's version or presets. Ask your dealer for details.

#### ◇ Cellular

Item	Description	Option/range	Default
Success Tone	Selects whether or not to enable the tone that indicates an individual call was successfully transmitted. ① The transmission result is also displayed on the screen.	ON or OFF	ON
Failure Tone	Selects whether or not to enable the tone that indicates an individual call failed. ① The transmission result is also displayed on the screen.	ON or OFF	ON
Call Tone (IND/GRP/ALL/ TEL)	Sets the call Initiation tone.	OFF, Tone1 ~ Tone8 ① Larger number makes the tone lower.	Tone1 (Pi)
Crtsy Beep (IND/GRP/ALL/ TEL)	Sets the call Termination beep.	OFF, Tone1 ~ Tone8 ① Larger number makes the tone lower.	Tone1 (Pi)
RX Tone (IND/GRP/ALL/ TEL/MSG)	Sets the call Receive tone.	OFF, Tone1 ~ Tone8 ① Larger number makes the tone lower.	OFF
Notify Type (IND/GRP/ALL/ TEL)	Sets the call receive notification type.	P-Bell or Pocket beep	P-Bell
Notify No. (IND/GRP/ALL/ TEL/MSG)	Sets the number of tones.	Continuous (Except for "MSG"), 1, 3, 10, 20 (times)	3 (times)
RX Notify Actn.	Sets the call or message receive notification type.	Tone, Vibration, or Tone + Vibration	Tone
Out of Rng Tone	Selects whether or not to enable the Out-of-Area Warning Beep. The beep also sounds when the transceiver reenters the service area.	OFF or ON	OFF
Range Side Tone	Selects whether or not to mute the Side Tone when the transceiver is out-of-area.	OFF or ON	OFF
Sidetone	Selects whether or not to output your voice to a headset that is connected to the transceiver. ① The function outputs your voice even if you are not holding down [PTT], depending on the attached microphone. (p. 7-5)	OFF or ON	OFF
Sidetone Volume* <sup>6</sup>	Sets the Side tone volume.	0 ~ 32	10

\*<sup>6</sup> Displayed only when "ON" is selected in the "Sidetone" item.

## 6 SET MODE

### Set mode items (Continued)

The shaded items are also displayed in the Basic Set mode.

① Items or default values may differ, depending on the transceiver's version or presets. Ask your dealer for details.

#### ◇ Cellular

Item	Description	Option/range	Default
Echo Cancellor	Selects whether or not to enable the Echo Cancelling function. ① Commonly used for an earphone MIC, and headset. ② This function is not usable when the "Sidetone" is set to "ON."	ON or OFF	ON
RX Buffer Type	Sets the Jitter buffer size. ① Jitter buffer reduces audio interruptions.	Dynamic, 40 ~ 480 milliseconds (in 40 milliseconds step)	Dynamic
Call Type Stnby	Selects whether or not to display the call-to party (Call type)* on the standby screen. *Preset by your dealer.	ON or OFF	ON
One Touch PTT	Selects whether or not to enable the One-Touch PTT function. The function toggles receiving and transmitting by momentarily pushing [PTT]. ① Push [PTT] to talk, and push again to return to receive. ② When "ON" is selected, you do not have to hold down [PTT] while you are talking.	OFF or ON	OFF
Destination ID	Selects a Destination ID display option. ① If "OFF" is selected, the call-to party (call type) that is preset by your dealer is displayed on the standby screen.	OFF, All Operations, Transmit and Receive, or Transmit	OFF
Show SIM Selection	Selects whether or not to display the "SIM Selection" item by pushing [FUNC] on the standby screen.	ON or OFF	ON
SIM Selection	Selects a SIM card. (p. 3-8) ① Rotate Rotary Selector or push [▲] or [▼] to select a SIM card, and then push [Call History] to restart the transceiver.	___* (SIM1) *A SIM card name is displayed, if it is named.	___ (SIM1)
Show Network Select	Selects whether or not to display the "Network Select" item by pushing [FUNC] on the standby screen.	OFF or ON	OFF
Network Select	Selects whether or not to automatically select a network carrier.	Auto, Last accessed, or User select	Auto
Cellular Unit Version	Displays the internal cellular unit version.	—	—
IMEI	Displays the Communication unit's IMEI number.	—	—
Phone Number*7*8	Displays the SIM card's telephone number.	—	—
ICCID*8	Displays the SIM card's ICCID.	—	—

\*7 May not be displayed, depending on the inserted SIM card.

\*8 Displays the phone number and ICCID of the SIM card that is selected in the "SIM Selection" item.



### Set mode items (Continued)

The shaded items are also displayed in the Basic Set mode.

① Items or default values may be differ, depending on the transceiver's version or presets. Ask your dealer for details.

#### ◇ IDAS

Item	Description	Option/range	Default
SQL Level	Selects whether or not to display the Squelch level adjustment screen by pushing [FUNC].	ON or OFF	ON

# Section 7 FOR YOUR REFERENCE

---

Specifications .....	7-2
◇ General .....	7-2
◇ 4G (LTE)/3G (W-CDMA) .....	7-2
◇ IDAS .....	7-2
◇ Transmitter .....	7-3
◇ Receiver .....	7-3
◇ Bluetooth .....	7-3
Options .....	7-4
◇ Battery pack/Battery case .....	7-4
◇ Chargers .....	7-4
◇ Antennas .....	7-4
◇ Others .....	7-4
◇ About the Side Tone function and headset .....	7-5
◇ Using the BC-227 DESKTOP CHARGER .....	7-5
◇ Using the BC-226 DESKTOP CHARGER .....	7-6
◇ Using the BP-305 battery case .....	7-7
◇ Using the LC-195 leather case .....	7-8
◇ Using the HM-238MC TIEPIN TYPE MICROPHONE with a [Sub PTT] switch .....	7-9
Troubleshooting .....	7-10

## Specifications

- ① Measurements made without an antenna.
- ① All stated specifications are subject to change without notice or obligation.

### ◇ General

- Antenna impedance (For IDAS): 50 Ω nominal
- Input impedance (MIC): 2.2 k Ω
- Output impedance (audio): 8 Ω
- Audio power output:
  - Internal speaker 1300 mW typical (at 5% distortion into an 8 Ω load)
  - External speaker 650 mW typical (at 5% distortion into an 8 Ω load)
  - HM-222H 1300 mW typical (at 5% distortion into an 8 Ω load)
- Operating temperature range: -30°C ~ +60°C (-22°F ~ +140°F)
- Power supply voltage: 7.5 V DC nominal
- Current drain (approximately):
  - RX stand-by 300 mA
  - RX max. audio 520 mA (Internal speaker)
  - TX High (5 W) 1.8 A
- Dimensions: 61.7 (W) × 42.8 (D) × 140.5 (H) mm,  
2.4 (W) × 1.7 (D) × 5.5 (H) in (with BP-303)
- Weight (approximately): 320 g, 11.3 oz (with BP-303)

### ◇ 4G (LTE)/3G (W-CDMA)

- Frequency band:
  - USA version LTE Band 2, 4, 12  
W-CDMA Band 2, 5
  - EUR/EXP-02 version LTE Band 1, 3, 7, 8, 20  
W-CDMA Band 1, 8
  - AUS/EXP-01 version LTE Band 1, 3, 5, 7, 8, 28  
W-CDMA Band 1, 5
- Modulation: QPSK, 16QAM, 64QAM
- Rated output power: 0.25 W
- Receiver sensitivity (QPSK): -95 dBm maximum, -102 dBm typical

### ◇ IDAS

- Frequency range:
  - IP730D 136 MHz ~ 174 MHz
  - IP740D 350 MHz ~ 470 MHz, 400 MHz ~ 520 MHz
- Number of conventional channels: 128 ch / 8 Zone
- Type of emission:
  - USA version 11K0F3E (15.0kHz), 4K00F1E, 4K00F1D (6.25 kHz)
  - EUR/EXP/AUS version 8K50F3E (12.5kHz), 4K00F1E, 4K00F1D (6.25 kHz)

Specifications (Continued)

◆ **Transmitter**

- Rated output power: 5 W (High), 2 W (Low 2), 1 W (Low 1)
- Modulation: Frequency modulation, FSK modulation
- Frequency error:  $\pm 1.0$  ppm
- Spurious emissions:
  - USA/EXP version 70 dB minimum, 90 dB typical
  - EUR/AUS version 0.25 uW (Less than 1GHz),  
1.0 uW (More than 1GHz)
- Adjacent channel power:
  - IP730D 60 dB minimum 70 dB typical
  - IP740D 60 dB minimum 64 dB typical
- FSK Error: 5 % maximum, 1 % typical
- FM Hum and Noise: 34 dB minimum, 60 dB typical (Without CCITT Filter)

◆ **Receiver**

- Sensitivity:
  - IP730D
    - USA/EXP version 0.32 uV maximum (at 12 dB SINAD)  
0.22 uV typical (at 12 dB SINAD)
    - EUR/AUS version 0.0 dBuVemf maximum (at 20 dB SINAD)  
-2.0 dBuVemf typical (at 20 dB SINAD)
  - IP740D
    - USA/EXP version 0.32 uV maximum (at 12 dB SINAD)  
0.17 uV typical (at 12 dB SINAD)
    - EUR/AUS version 0.0 dBuVemf maximum (at 20 dB SINAD)  
-2.0 dBuVemf typical (at 20 dB SINAD)
- Adjacent channel selectivity: 60 dB minimum, 67 dB typical
- Intermodulation:
  - IP730D
    - USA/EXP version 70 dB minimum, 74 dB typical
    - EUR/AUS version 65 dB minimum, 67 dB typical
  - IP740D
    - USA/EXP version 70 dB minimum, 72 dB typical
    - EUR/AUS version 65 dB minimum, 66 dB typical
- Hum and Noise: 34 dB minimum, 60 dB typical (Without CCITT Filter)

◆ **Bluetooth**

- Version: 4.2
- Output power: Class 2
- Profile: HFP, HSP
- Modulation: GFSK,  $\pi/4$ -DQPSK, 8DPSK

## Options

### ◇ Battery pack/Battery case

#### • BP-302/BP-303 BATTERY PACK

Battery pack	Voltage	Capacity	Approximate battery life*
<b>BP-302</b>	7.2 V	1950 mAh (Minimum) 2010 mAh (Typical)	15 hours
<b>BP-303</b>	7.2 V	3250 mAh (Minimum) 3350 mAh (Typical)	25 hours

\* In the Cellular mode, the operating periods are calculated under the following conditions.

TX : RX : standby = 5 : 5 : 90

The battery life may shorter, depending on the distance with the cellular station or the signal strength.

#### • BP-305 BATTERY CASE

Battery case with 5 AA battery cells.

### ◇ Chargers

#### • BC-227 DESKTOP CHARGER + BC-242 AC ADAPTER, BC-123S AC ADAPTER, OPC-515L DC POWER CABLE,

To rapidly charge the battery pack.

Charging time: Approximately 4.4 hours for the BP-303

① OPC-515L must be purchased separately.

#### • BC-226 DESKTOP CHARGER + BC-228 AC ADAPTER

You can connect up to 6 BC-226 together.

Charging time: Approximately 4.2 hours for the BP-303

① A power adapter may be supplied, depending on the charger's version.

### ◇ Antennas

#### • FA-SC25V/FA-SC28V/FA-SC29V/FA-SC55V

VHF ANTENNAS  
FA-SC25V 136–150 MHz  
FA-SC28V 148–162 MHz  
FA-SC29V 160–174 MHz  
FA-SC55V 150–174 MHz

#### • FA-SC26VS/FA-SC27VS/FA-SC56VS/FA-SC57VS

VHF STUBBY ANTENNAS  
FA-SC26VS 136–144 MHz  
FA-SC27VS 142–150 MHz  
FA-SC56VS 150–162 MHz  
FA-SC57VS 160–174 MHz

#### • FA-SC61VC VHF CUT ANTENNAS

FA-SC61VC 136–174 MHz

#### • FA-SC01U/FA-SC02U/FA-SC03U/FA-SC25U/FA-SC57U/FA-SC72U/

UHF ANTENNAS  
FA-SC01U 350–400 MHz  
FA-SC02U 330–380 MHz  
FA-SC03U 380–430 MHz  
FA-SC25U 400–430 MHz  
FA-SC57U 430–470 MHz  
FA-SC72U 470–520 MHz

#### • FA-SC26US/FA-SC73US UHF STUBBY ANTENNAS

FA-SC26US 400–450 MHz  
FA-SC73US 450–490 MHz

#### • FA-SC61UC UHF CUT ANTENNAS

FA-SC61UC 380–520 MHz

#### • FA-SC62V/FA-SC63V HIGH GAIN ANTENNAS

FA-SC62V 155 MHz  
FA-SC63V 160 MHz

### ◇ Others

#### • MB-136, MB-133 BELT CLIP

#### • MB-96F, MB-96FL, MB-96N BELT HANGERS

#### • LC-195 CARRYING CASE + MB-57L SHOULDER STRAP

#### • VS-3 Bluetooth® HEADSET

The Bluetooth headset with a [PTT] switch.

#### • VS-4MC/VS-5MC\* PTT SWITCH CABLE

+ HS-94, HS-95, HS-97 HEADSET

VS-5MC: Used to connect a headset to a transceiver.

HS-94: Ear-hook type

HS-95: Neck-arm type

HS-97: Throat microphone

\* Non-waterproof

#### • HM-184, HM-222, HM-222H, HM-236 SPEAKER MICROPHONE

HM-184, HM-236: Meets IP67 waterproof protection.

HM-222: Meets IP68 waterproof protection.

HM-222H: Higher power version of the HM-222.

#### • HM-163MC TIEPIN TYPE MICROPHONE

#### • HM-238MC TIEPIN TYPE MICROPHONE

With a [Sub PTT] switch.

#### • EH-15B EARPHONE, SP-26 TUBE EARPHONE,

SP-28 EAR HOOK TYPE EARPHONE

For use with the HM-163MC or HM-238MC

#### • SP-27 TUBE EARPHONE, SP-29 EAR HOOK

TYPE EARPHONE, SP-40 EARPHONE + AD-135

EARPHONE ADAPTER

AD-135: Used to connect an earphone to the transceiver's Multi-connector.

#### • CP-23L CIGARETTE LIGHTER CABLE

Used when charging a battery pack through a cigarette lighter socket.

Options (Continued)

◇ About the Side Tone function and headset

The Side tone function (p. 6-7) works differ depending on the connected microphone, as shown below.

**When the HM-238MC or VS-5MC is attached:**  
The transceiver always outputs your voice to a headset.

**When the HM-163MC, HM-184, HM-222, HM-222H, HM-236, or VS-4MC is attached:**  
The transceiver outputs your voice to a headset while holding down [PTT].

◇ Using the BC-227 DESKTOP CHARGER

Charging time: approximately 4.4 hours for the BP-303.

**CAUTION:** Before using the charger, read the 'Battery caution' and 'Charging caution' on the INSTRUCTIONS that boxed with the transceiver.

○ Status indicator

Light color	Status
Orange	Charging
Green	Charging is completed.
Blinks orange and green	Charging failed. It may have some problems.

**NOTE:**

- The transceiver **MUST** be turned OFF while charging. Otherwise:
  - The battery will not be charged properly.
  - The battery life may be shortened.
- Do not transmit while charging. When you need to transmit, remove the transceiver from the charger, and then turn ON the power.
- If the battery pack does not properly charge when it is attached to the transceiver, remove it from the transceiver and insert only the battery pack into the charger.

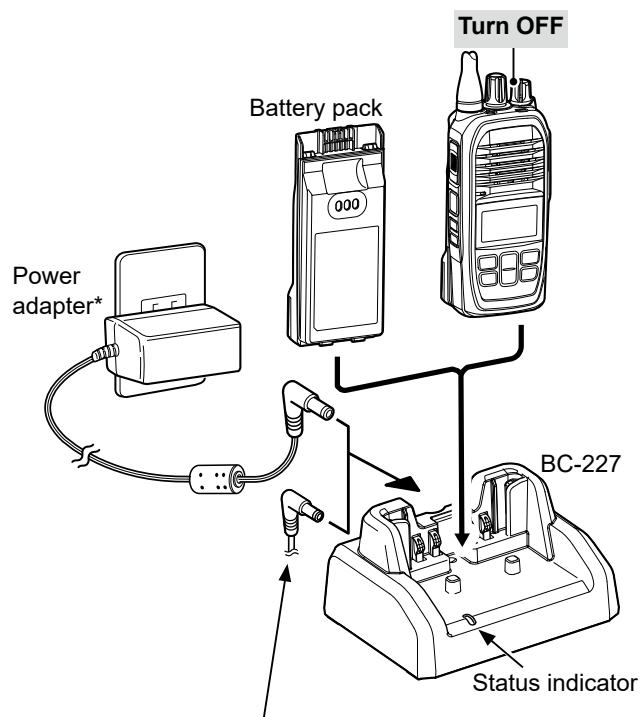

The CP-23L (for a 12 V cigarette lighter socket) can be used instead of the power adapter.

\*The shape may be different, depending on the charger version

Options (Continued)

◇ Using the BC-226 DESKTOP CHARGER

Charging time: approximately 4.2 hours for the BP-303.

**CAUTION:** Before using the charger, read the 'Battery caution' and 'Charging caution' on the INSTRUCTIONS that boxed with the transceiver.

○ Status indicator

Light color	Status
Orange	Charging
Green	Charging is completed.
Blinks orange and green	Charging failed. It may have some problems.

**NOTE:**

- The transceiver **MUST** be turned OFF while charging. Otherwise:
  - The battery will not be charged properly.
  - The battery life may be shortened.
- Do not transmit while charging. When you need to transmit, remove the transceiver from the charger, and then turn ON the power.
- If the battery pack does not properly charge when it is attached to the transceiver, remove it from the transceiver and insert only the battery pack into the charger.

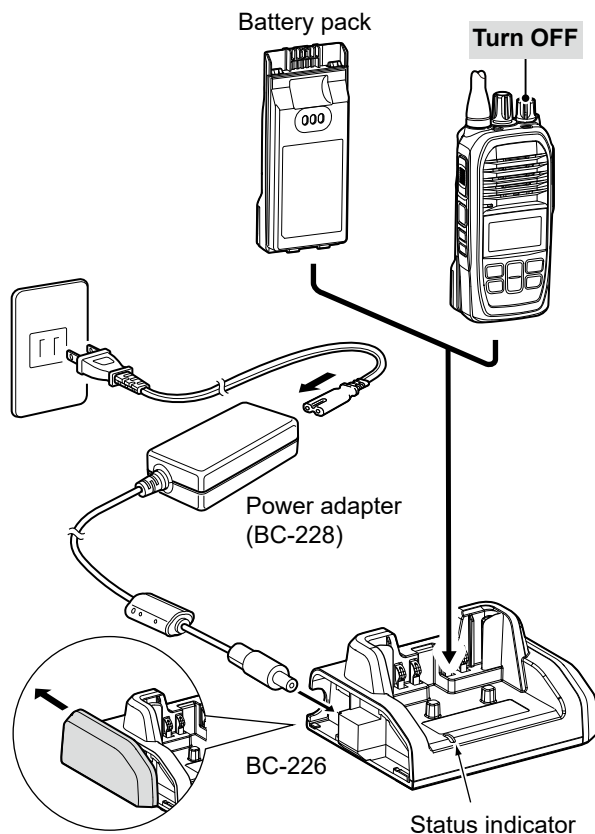

○ Connecting the BC-226 together

You can connect up to 6 BC-226 together.

1. Remove the charger's right cover. (1)
2. Snap the DC power plug to the another charger's DC power jack. (2)

**WARNING: NEVER** connect more than 6 chargers together. It may result in an electric shock, cause a fire, overheating, or damage chargers.

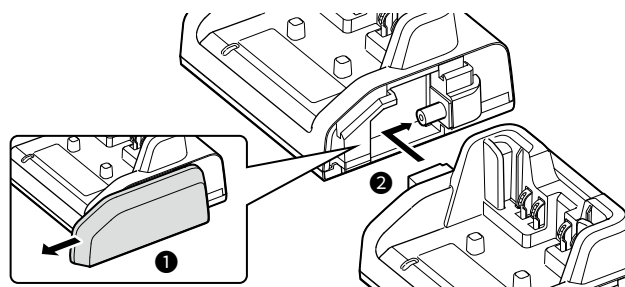

○ Fuse replacement

If a fuse blows, find and repair the cause of the problem. Then replace the damaged fuse with a new, adequately rated fuse.

Fuse type: 5 A/58 V (low profile mini blade fuse)

**NOTE:** Remove the fuse using needle-nose pliers.

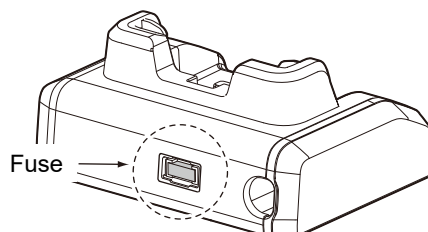

Options (Continued)

◇ Using the BP-305 battery case

Install 5 × AA (LR6) size alkaline batteries, as shown below.

1. Open the battery case.

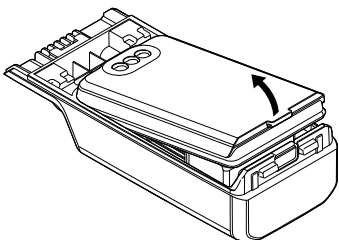

2. Push the tab (1), and then remove the battery holder (2).

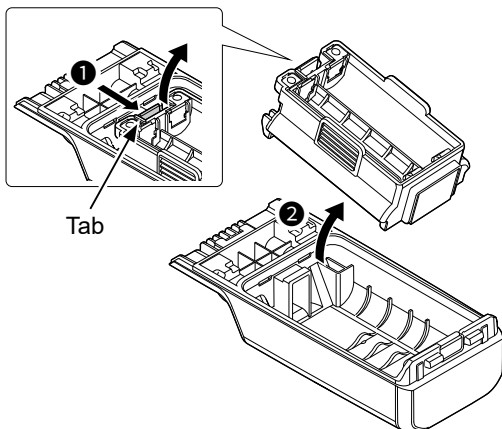

3. Install batteries in the holder.

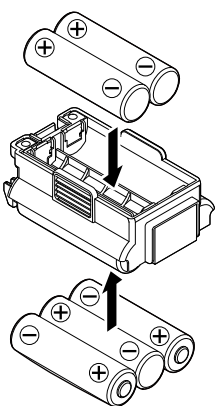

4. Insert the battery holder to the battery case until the tab makes a 'click' sound.

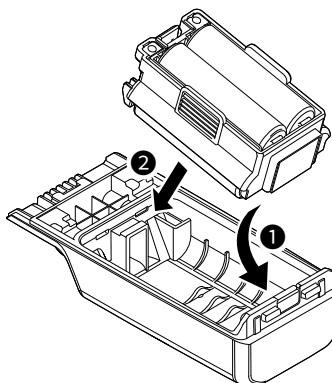

5. Firmly close the battery case.

① Make sure that the waterproof packing does not stick out of the case.

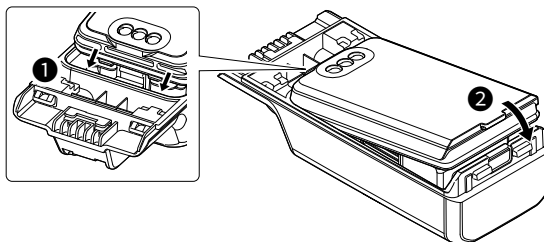

**WARNING: NEVER** use batteries other than alkaline batteries, such as manganese batteries or rechargeable batteries. It may cause rupture, ignition, fire, heat generation, liquid leakage, electric shock, and burns.

**CAUTION:**

- **DO NOT** incinerate used battery cells since internal battery gas may cause them to rupture.
- **DO NOT** expose a detached battery case to water. If the battery case gets wet, be sure to wipe it dry before using it.
- **DO NOT** use batteries whose insulated cover is damaged.

**NOTE:**

- When installing the batteries, make sure they are all the same brand, type and capacity. Also, do not mix new and old batteries together.
- Keep the battery terminals clean. It's a good idea to occasionally clean them.
- Remove alkaline batteries when the battery case is not used.
- The transceiver turns OFF when the battery case voltage falls below the operating range of the transceiver.
- The transmission output power in the IDAS mode will be reduced to low power when using the battery case and alkaline batteries.



Options (Continued)

◇ Using the LC-195 leather case

The LC-195 is a leather case that is usable when the battery pack is attached. Adjust the fixing position with the hook-and-loop fasteners.

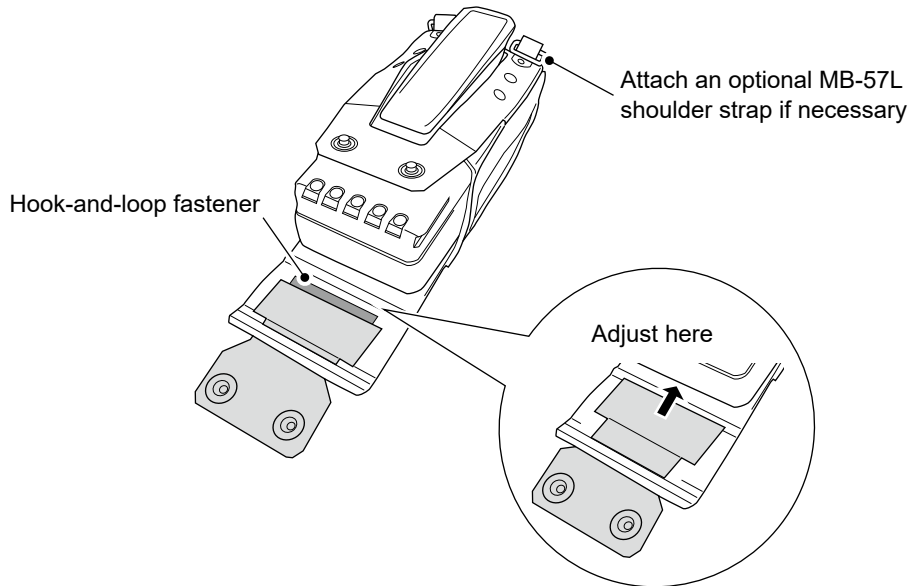

You can charge even when the leather case is attached, as shown below.

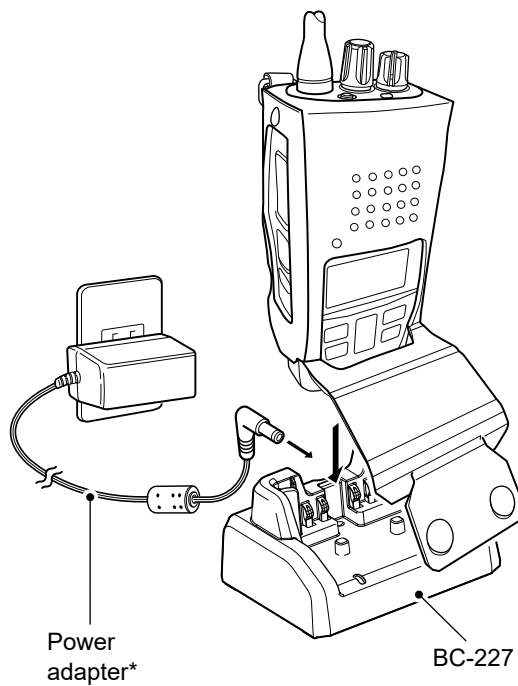

\*The shape may be different, depending on the charger version

Options (Continued)

◇ Using the HM-238MC TIEPIN TYPE MICROPHONE with a [Sub PTT] switch

The HM-238MC is a Tie-clip type microphone that can operate the [PTT], [Sub PTT], and [Side 1] switches of the transceiver.

**NOTE:** When the HM-238MC is attached to the transceiver, no audio is output from the transceiver's speaker. **BE SURE** to connect the EH-15B, SP-26, or SP-28 earphones to the HM-238MC before use.

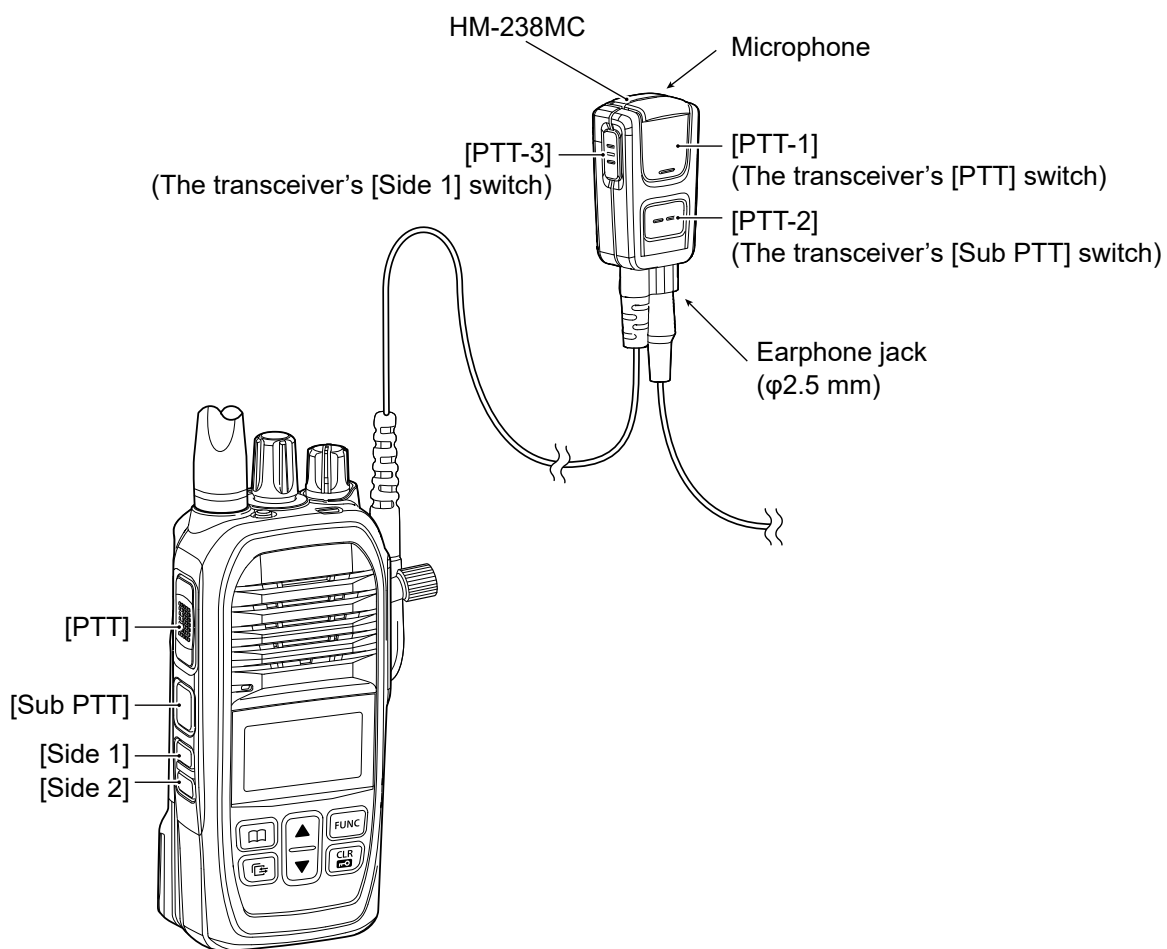

## Troubleshooting

The following conditions are not due to a malfunction. Check before sending a request for repair.

---

### No power comes ON.

- Loose connection of the battery pack.
  - Clean the battery pack terminals.
- The battery is exhausted.
  - Charge the battery pack. (p. 7-5)
- The battery pack's over-discharge protection circuitry is activated.
  - Remove the battery pack from the transceiver, then charge it for a while.  
Attach the battery pack to the transceiver again, then turn ON the power.

---

### No sound comes from the speaker nor earphone.

- Volume level is set too low.
  - Rotate [VOL] to adjust the volume level.
- Loose earphone plug connection.
  - Firmly insert the plug.

---

### Calls cannot be made

- The call-to party number or group number is wrong.
  - Check the call-to party number or group number.

---

### No beep sounds

- Key Beep Volume level is set too low.
  - Set the volume to a suitable level in the Set mode. (p. 6-3)

---

### The "4G" blinks, or "Connecting..." is displayed (standby screen is not displayed)

- The transceiver is located out of the service area.
  - Move your location.
  - Restart the transceiver.

---

### No reply is received.

- The transceiver is located out of the service area. ("4G" blinks.)
  - Move your location, and then try again.
- The transceiver is not registered to the system. ("4G" is displayed.)
  - Push [PTT] to re-register the transceiver to the system.
  - Wait for a while, or change your location.
  - Check that the Cellular line is established.
- The operator is away from the transceiver, or the transceiver is turned OFF.
  - Wait until the operator is back, or ask your system manager.

---

### "Key lock" is displayed when you push any keys

- The keys are locked.
  - Hold down [CLR/Lock] to unlock. (p. 2-4)

### Troubleshooting (Continued)

---

#### **The charging indicator blinks orange, or alternately blinks orange and green**

- The battery pack is not properly inserted.
  - Properly insert the battery pack. (p. 7-5)
- Charging the battery pack outside of the chargeable temperature range.
  - Charge the battery pack in the chargeable temperature range (0°C to 60°C (32°F to 140°F)).
- Loose connection of charging transceivers.
  - Clean the charger terminals.
- The transceiver power is ON while charging.
  - Turn OFF the power while charging. (p. 7-5)

---

#### **The charging indicator is OFF even the battery pack is inserted to the charger**

- The battery pack is not properly inserted.
  - Properly insert the battery pack. (p. 7-5)

---

#### **The deleted recorded audio still exists, or the recorded audio is lost**

- The battery pack was removed before the recorded audio was deleted/saved from/to memory.
  - Remove the battery pack after "Power OFF..." is displayed.

---

#### **Failed to pair your Bluetooth headset**

- The Bluetooth headset is not in the Pairing mode.
  - Confirm the Bluetooth headset is in the Pairing mode, and then try again. (p. 5-3)
- There are other active Bluetooth devices nearby.
  - Stop using other Bluetooth devices.
  - Use the transceiver away from other Bluetooth devices.
- There are other devices that are operating in the 2.4 GHz band.
  - Use the transceiver away from the other devices, or stop using those devices.

---

#### **"Pairing list is full" is displayed in the Pairing screen.**

- Number of paired devices exceeds the maximum number possible.
  - Delete a Bluetooth device from the pairing list.

---

#### **The call was suddenly cut off /Noise is heard**

- Too far from the Bluetooth device (When using a Bluetooth headset).
  - Get closer to the Bluetooth device.
    - ① The communication range of Bluetooth is approximately 10 meters (33 feet).
- Electromagnetic interference from other electronic devices.
  - Use the transceiver away from the other devices, or stop using those devices.

**Count on us!**

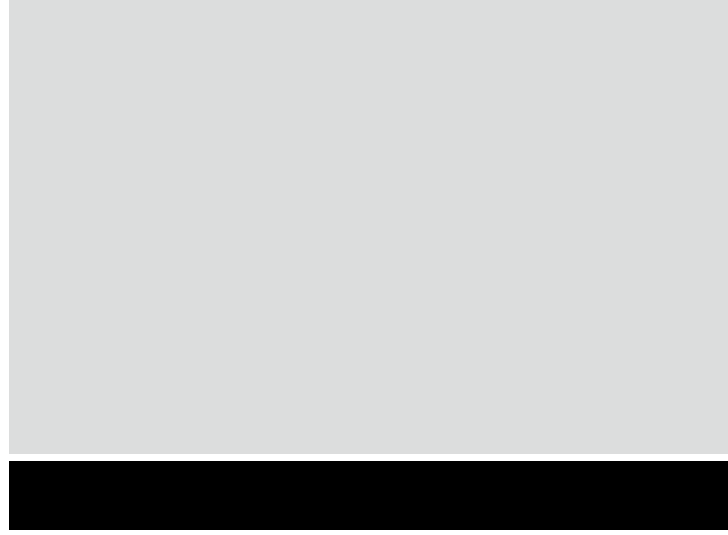

---

---

---

---

---

---

---